

# electronics

radio, communication, industrial applications of electron tubes . . . engineering and manufacture



IONIC PATHWAY  
Air bombarded by  
Harvard's cyclotron

McGRAW-HILL  
PUBLISHING COMPANY, INC.

SEPTEMBER 1940

In two parts

Price 50 Cents



Western Electric

DUPONT

BRUSH



Farnsworth

A TRANSFORMER SOURCE



SIGNAL CORPS



PRESTIGE LEADERS OF INDUSTRY

U.S. NAVY

ASTATIC

PHILCO

Naval Research

A list of UTC users reads like the blue book of industry. Chosen for quality, dependability and unusual designs, UTC has solved many transformer application problems. May we cooperate with you on your application?



WESTON

COAST GUARD

Johns-Manville



U.S. ARMY

Amperex

AEROVOX

Bureau of Standards



UNITED TRANSFORMER CORP. NEW YORK, N. Y.

150 VARICK STREET EXPORT DIVISION: 100 VARICK STREET NEW YORK, N. Y. CABLES: "ARLAB"

# THE ELECTRON ART

Among the subjects discussed in this month's review of the technical literature are applications of sound in the theater, getters, solar components of cosmic rays, and an impedance bridge

## Sound in the Theater

A SUBJECT OF considerable interest is discussed in the January, 1940 issue of the *Journal of the Acoustical Society of America*, by Harold Burris-Meyer. The article is entitled "Sound in the Theater," and it discusses research in the application of sound to the stage performed by the author at Stevens Institute of Technology and at various legitimate theaters. Of the two significant components of the show, visual and auditory, one, the visual, has been subject to control and by the same token is flexible enough to give considerable scope to the artist in the theater. All the audience sees depends upon the light originating on or reflected from the stage. The artist in the theater not only has a flexible tool in light, he has a considerable body of knowledge which makes it possible for him to get definite predictable results with the visual components of the show. With respect to the auditory components of the show, however, we are still in a sub-primitive condition. We have been handicapped in our effort to control sound by limitations inherent in the source. A harp can only play so loud, a singer sing so high. Prop wind comes only from where the wind machine is placed. The Pilgrim's Chorus can move only so far. The research program was first devoted to the removal of the limitations on the control of sound so you can have the kind of sound you want, where you want it, when you want it and the way you want it, and second to the exploration of the means by which audience responds to the auditory aspects of the show may be discovered.

If the limitation on the control of sound in the theater is removed, there must be learned what sound must and can do in the theater. The uses of sound were known centuries ago. Control limitations only narrowed their scope. First the actor must be heard. After that sound can be used to establish local atmosphere and moods and as an independent arbitrary emotional stimulus, as an actor to reveal character to advance the plot all these independently or counterpointing or reinforcing their equivalent in the visual component of the show. It must also be known which aspects of sound are theatrically useful and it is apparent at once that there isn't any aspect that isn't. They all must be controlled.

The legitimate theater has a different size audience almost every night and

a different set almost every scene. The acoustic variations thus introduced are obvious. Unless they are provided for in the design of the theater, the house is obsolete before the curtain ever goes up. It is suggested by Mr. Burris-Meyer that theater designers give consideration to Sidney Wolf's precepts to the effect that the theater of the future will be acoustically dead and all sound will be distributed and given the requisite reverberations by thermionic amplification.

The author gives little information about the apparatus used because he says the experimental apparatus is completely redesigned and rebuilt as often as a problem comes along which can't be solved with the equipment available. Mr. Burris-Meyer concludes his paper with an admonition. "If you can't reproduce sound well enough to prevent the audience guessing that you have a sound system, throw the system out. Get your dramatic effect some

other way. You can't escape sound. Badly handled sound is worse than scenery that falls down. It destroys utterly any illusion the actors have managed to create."

. . .

## Gettering Powers of Various Metals

AN ARTICLE OF INTEREST to vacuum tube engineers and others working with high vacuums appears in the February 1940 issue of the *Journal of Applied Physics*. Its title is "An Investigation into the Gettering Powers of Various Metals for the Gases Hydrogen, Oxygen, Nitrogen, Carbon Dioxide and Air" and the authors are Louis F. Ehrke and Charles M. Slack. The metals investigated include magnesium, aluminum, barium, misch metal (active constituents are largely cerium and lanthanum), thorium, uranium, and zirconium. Barium was tested in several of its various commercial forms.

The gettering powers of diffuse layers of the metals produced by vaporizing the getters in the presence of a gas and the bright deposits produced by vaporization in a vacuum are compared and the superior results obtainable from the first mentioned confirmed. The effect of temperature on the keeping powers of the various getters is discussed. Aluminum and mag-

## FREQUENCY MODULATION BEFORE THE FCC



Edwin H. Armstrong (left) explaining his method of noiseless broadcasting to James L. Fly, chairman of the Federal Communications Commission during the FCC's recent hearing on frequency modulation. One of the first superheterodyne receivers, developed by Major Armstrong, is being examined. A full report of hearing appears on page 14

**EACH  
'TOPS'  
IN  
Performance**

**Economically  
Priced**

Other Models  
up to \$150

**Ask Your  
Jobber for  
CATALOG  
Including  
New Releases**

Mailed Direct  
on Request

**Licensed  
by  
ELECTRICAL  
RESEARCH  
PRODUCTS  
COMPANY  
and  
THE BRUSH  
DEVELOP-  
MENT  
COMPANY**

**AMERICAN  
MICROPHONE  
COMPANY**

1915 So. WESTERN AVENUE  
LOS ANGELES, CALIFORNIA

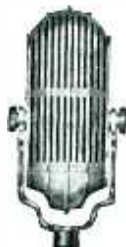

nesium and misch metal are the most active getters in the presence of mercury vapor, although the commercially available forms of barium may make it more suitable for this purpose.

• • •

**Solar Component of  
Cosmic Rays**

"SOLAR INFLUENCES on the Cosmic Ray Intensity at High Elevations" is the title of an article by S. A. Korff appearing in the January 1940 issue of the *Journal of Franklin Institute*. In an effort to determine whether any component of the cosmic radiation might be of solar origin, balloons carrying cosmic ray measuring equipment and automatic radio transmitters were sent into the upper reaches of the earth's atmosphere. Ascensions as high as 80,800 feet were made. The article discusses the results of four such flights, two during the daylight hours and two at night.

A solar component might be expected to make its presence known by a day to night variation in the intensity of cosmic radiation or as an increase in intensity during periods of disturbance on the sun's surface such as during a solar flare. The variation of the solar component measured in these tests is to distinguish from the well known diurnal variation which occurs at sea level and is believed to be of terrestrial origin. The variation in the cosmic ray intensity at high altitudes investigated here was less than the experimental error of 2 per cent and was estimated to be about 1.5 per cent which indicates that the sun is the source of a small portion of the cosmic radiation.

• • •

**A Direct-Reading  
Impedance Bridge**

FREQUENTLY WHEN WORKING with low frequencies the engineer must determine the impedance of a circuit at a definite frequency. In such a case the circuit elements as such have little meaning because the impedance should be thought of as an entity  $Z$  rather than consisting of components  $R$ ,  $L$  and  $C$ . In this regard it is well to note that most bridges measure the component

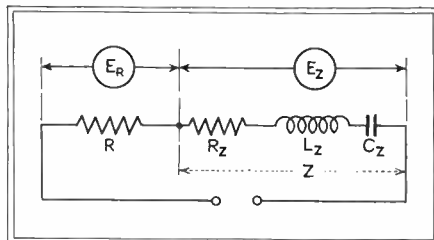
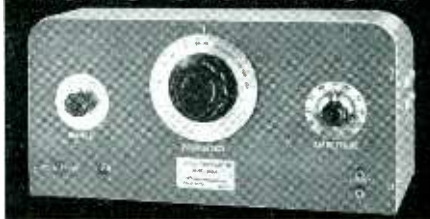

Fig. 1—Impedance measurement by comparison with a known series resistance

**RESISTANCE TUNED  
AUDIO OSCILLATORS**



**LOW DISTORTION**—less than 1% for distortion measurements on high quality audio equipment and broadcast transmitters.

**EXCELLENT STABILITY**—saves time because NO ZERO SETTING necessary

**WIDE FREQUENCY RANGE**—models available from 5 cps. to 200,000 cps.

**HIGH OUTPUT**—models available with 1 to 5 watts output.

**INEXPENSIVE**—the Model 200B, 20-20,000 cps., 1 watt output—only \$85.80 net f.o.b. Palo Alto, California.

*Write for complete information about these and other instruments*

**HEWLETT-PACKARD CO.**

481 Page Mill Road • Palo Alto, California

**Uncoated WIRE  
and RIBBON**  
for Direct Heated Emitters in  
**VACUUM TUBES**

☆ All specifications rigidly held from INGOT to FINISHED PRODUCT

**CLOSE SCIENTIFIC CONTROL** of all specified characteristics,  
• CHEMICAL COMPOSITION  
• SIZE and SHAPE • WEIGHT  
• TENSILE STRENGTH  
• ELONGATION  
• ELECTRICAL RESISTIVITY  
**BARE WIRES**—drawn to .0004" diameter  
**RIBBON**—rolled to less than .0001" thickness

Many special alloys and a complete range of very small sizes for 1.4 volt battery tubes and hearing aid tubes.

**SIGMUND COHN**

44 GOLD ST. NEW YORK

elements and the value of  $Z$  is obtained only after a series of calculations. Mr. L. Chrétien in an article on "Direct-Measuring Impedance Bridge" in the July 1939 issue of *L'Onde Electrique* discusses this problem and suggests a solution.

The simplest method of measuring impedance is by comparison with a known series resistor. The combination is operated at the desired frequency

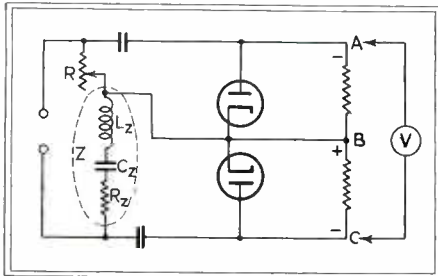

Fig. 2—Circuit to overcome phase difference difficulties

and the voltages across the two components are measured. The relation for the impedance is

$$Z = R \times E_z/E_r.$$

It is essential to use instruments of good accuracy and power as pure as possible. It is desirable to use a generator which is known to yield lower than 2 per cent harmonics at all frequencies above 100 cps.

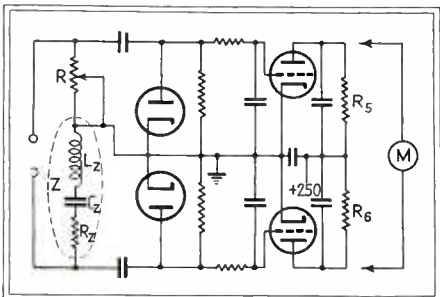

Fig. 3—Complete circuit diagram of the impedance bridge

It is not feasible to use the circuit shown in Fig. 1 as voltages  $E_r$  and  $E_z$  are neither in phase nor opposition. The arrangement of Fig. 2 overcomes this difficulty. When  $R = Z$  there is no voltage difference between the points A and C, the voltages applied between A and B and between B and C are of the same magnitude and of opposite phase. The circuit of Fig. 2 can be modified to that of Fig. 3 through the use of two triodes. Equilibrium is obtained by means of milliammeter  $M$  which holds its zero position when the bridge is not energized, assuming that the tubes have identical characteristics. Furthermore the readings are not affected by voltage variations of the feed network since both tubes are symmetrically connected and consequently do not affect the balance point of the galvanometer.

# OXFORD Speakers For Consistent Quality

So much is said about the virtues of MASS PRODUCTION that we are often led to believe it is an end in itself rather than the means to an end.

Although utilizing the many advantages of straight line production, the management of OXFORD-TARTAK RADIO CORP. has constantly insisted upon careful and painstaking craftsmanship in the production of every OXFORD SPEAKER.

This insistence upon care has evolved a code of excellence within our organization which guarantees a product of unsurpassed quality. This is the end to which Oxford constantly aspires.

Our years of service to the Radio and Sound industries is proof of the constancy of Oxford quality. Oxford speakers are

*Accepted by Sound Judgment*

Send us your specifications, or write Dept. E2 for bulletin 391.



**OXFORD-TARTAK**  
RADIO CORPORATION  
915 W. VAN BUREN ST. • CHICAGO, U. S. A.

## RA-243 Filter Set 38 ELECTRICAL FILTER COMBINATIONS



for acoustic and vibration testing

**T**HIS portable unit (measuring 19½" x 12¼" x 9¾") permits segregation of high frequencies, low frequencies or octave-width bands at half-octave intervals from 50 to 4800 cycles per second.

Having 38 filter combinations, this set is particularly adaptable, in con-

junction with a sound level meter, to many types of noise and vibration testing; including sound frequency analysis in the laboratory, establishment of acceptance standards, and production acoustic testing in the plant. For full details, write to our Engineering Laboratories.

**Electrical Research Products Inc.**

SUBSIDIARY OF

Western Electric Company

195 BROADWAY, NEW YORK

ENGINEERING LABORATORIES: 76 VARICK ST., NEW YORK

## ACCURACY PLUS AT LOWER COST



Whether your application need is for automatic control, keying, change-over, aircraft radio, etc., you'll get greater efficiency and dependability when your assembly includes Kurman relays.

### NEW! THE 25 RELAY . . .

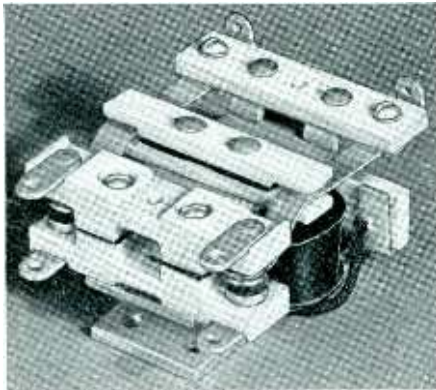

- Rugged, compact relay with low power consumption of 1.5 watts and high power output of 2,000 watts. Coin silver contacts— $\frac{1}{4}$ " Diam., cantilever spring action, self-cleaning wipe, Alsimag non-hygroscopic insulation, rugged, compact, foolproof.

### THE SENSITIVE RELAY . . .

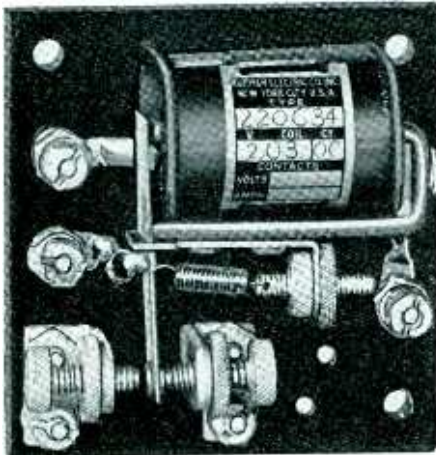

- High contact pressure, high operative speed and full armature balance in any position. Single pole, double throw, C type coin silver contacts; rated to carry 2 amperes at 110 volts. Precision adjustment. Coil will carry 3 watts without overheating. Available for requirements varying from 2 to 50 milliwatts input, and loads as high as 1,000 watts.

Cut production as well as experimental costs by specifying Kurman relays for the next job. Write today for descriptive literature; no obligation.

# KURMAN ELECTRIC CO. INC

241 Lafayette Street  
New York, N. Y.

## Time Checking

"CHECKING THE ACCURACY of New York City Telephone Time Service" by F. Ireland appears in the March 1940 issue of *The General Radio Experimenter*. The New York Telephone Co. for five cents, will tell anyone in New York City who will call MERidian 7-1212 the correct time within five thousandths of a second. The average person asking the time has no need for this highly precise time service, but it is provided for the benefit of jewelers, astronomers and others who may have use for it. To check the accuracy of the service a visual stroboscopic device, the Time Comparator, was developed.

The instrument is essentially a 113-kc amplifier which flashes a Strobotron lamp at the beginning of each Arlington time signal and at the beginning of the time tone sent to the telephone subscribers. The flash shows through a slit in a disk turning once per second and any variation in the time as compared to the Arlington signal is measured by the space between the flashes. The one-hundredth second scale graduations surrounding the rotating disk are three-sixteenths of an inch apart. The narrow slit permits reading to half-divisions or five thousandths of a second.

The time is checked each hour that the Arlington time signals are transmitted. The time source of the Time Bureau is the crystal clock at the Bell Telephone Laboratories and therefore the stability and accuracy transmitted to the bureau are unquestioned. The Time Comparator is the final check on the operation of several miles of cable, the clocks and the pulse control relays.

• • •

## AIRCRAFT RADIO AIDS IN TRAFFIC CONTROL

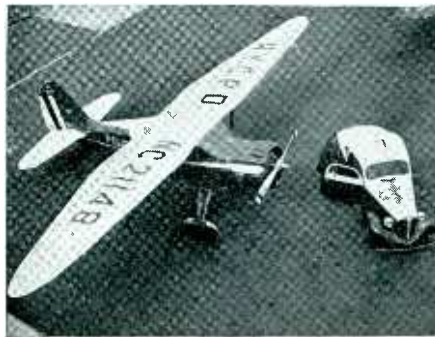

New York City's brand new Stinson police planes have taken on as an important duty the control of heavy week-end and holiday traffic from the air. From a vantage point high above the highways, the planes scout around and find spots where traffic is most congested as well as where congestion is least. By means of two-way radio service, this information is sent to police cars on the ground who can then assist in rerouting traffic

## Electric Fence Controllers

A PROBLEM of increasing importance during the past few years is the energizing of electric fences. The fences are used to control the movements of cattle and must not endanger either the lives of cattle or humans. A booklet covering this subject entitled "Electric Fence Controllers" was written by F. Alton Everest of the Oregon State College Engineering Experiment Station with special reference to equipment and methods developed for measuring the characteristics of such fences. The booklet briefly reviews the several types of apparatus used to energize the fences with the emphasis on safe operation. Most of the space is devoted to equipment and methods for the measurement of the electrical phenomena which take place in the energized fence.

• • •

## Progress in Radio Broadcasting in England

THE OUTSTANDING ADDITIONS on the transmitting side of radio broadcasting development in England during the months of 1939 prior to the outbreak of war in Europe were the high power transmitting station at Start Point in South Devon, and the medium power station at Clevedon, near Bristol. Both of these transmitters were designed and constructed for the B.B.C. by Standard Telephones and Cables, Ltd., associated company in England of the International Telephone and Telegraph Corporation.

The transmitter at Start Point is a 100 kw installation with a directional radiator system phased on the allotted wave length of 285.7 meters. The system consists of two mast radiators each 450 feet in height spaced  $\frac{3}{4}$  of a wave length apart and so phased as to obtain the desired horizontal polar diagram. Each mast is divided at a height of 310 feet by a compression insulator bridged by a suitable impedance. The medium power station at Clevedon, 20 kw was equipped with an omni-directional mast aerial 375 feet high.

The introduction of these two stations will give a reliable service of an alternative Regional program to some 3,000,000 living on the South and Southwest Coasts of England or in the inland area adjoining.

Orders have been placed for two new Regional transmitters each of 120 kw, the maximum power permitted by the new Broadcasting Convention at Montreux. These were intended for service at Brookman's Park (London Regional) and Moorside Edge.

Developments in quartz crystal technique applied to crystal oscillators of extreme accuracy led to the installation of independent crystal drives at broadcasters sharing a common wave length and resulted in greatly improved synchronization between them. In 1939 this system of crystal drive was ex-

**GOAT TUBE SHIELD FEATURES**  
that simplify set manufacturing

# 6-ONE-STEP AHEAD



Goat Tube Shields are one step ahead . . . because 1— they meet the exacting needs of changing tube and set design . . . 2— they incorporate the soundest features of tube engineering and design . . . 3— they are available for every conceivable requirement. All of which have helped to make Goat Tube Shields the most widely used of any independent manufacturer. Bring your tube shield problems to Goat for quick, easy, economical solution.

## GOAT TUBE SHIELD FEATURES:

- 1 Variety
- 2 Maximum Compactness
- 3 High Appearance Value
- 4 Tested Performance
- 5 Quick Service



Send for Bulletins

**GOAT RADIO TUBE PARTS, INC.**  
(A DIVISION OF THE RED GOAT CO., EST. 1897)  
314 DEAN ST., BROOKLYN, N. Y.

## NEW TERMINALS

*With Wide Range Utility*



135-A



136-A



135-B



135-C



135-D



137-C

The No. 136 and 137 Series also have four types of terminals with same terminal arrangements as No. 135 Series. Made up in panels of two or more terminals.

Our line of standard parts is constantly being increased to give you the most complete service for Terminal Panels, Terminals, Plugs, Sockets, etc. Specials also made to your blue print. Write for new catalog today. Address Dept. 10.

**HOWARD B. JONES**  
2300 WABANSIA AVENUE,  
CHICAGO ILLINOIS

tended to the remaining Regional stations in England working on exclusive wave lengths.

The new studio center at Queen Margaret College, Glasgow, second largest in Great Britain was inaugurated late in 1938 and has given splendid service throughout 1939. It includes ten new studios including one which is large enough to handle an orchestra of 100 musicians.

In order to cover the increased requirements of existing zones and the extension of the Overseas short wave services from England to additional parts of the world, new aerial arrays were constructed at the Overseas short wave station. Two high power transmitters for the short wave service were brought into service in February and another transmitter was ordered in July. This brings the total number of high power short-wave transmitters in the Overseas service to six.

Considerable further progress was made in England in 1939 in the technique of television, and the number of television outside broadcasts was greatly increased. Pictures were transmitted successfully over ordinary telephone lines up to distances of four miles and this enabled many program sources to be linked to the special balanced pair television cable which circles the central part of London.

For outside broadcasts, passed by radio link from one of the two mobile units consisting of scanning and ultra short wave transmitting vans, the re-

## JAPAN GETS ELECTRON MICROSCOPE

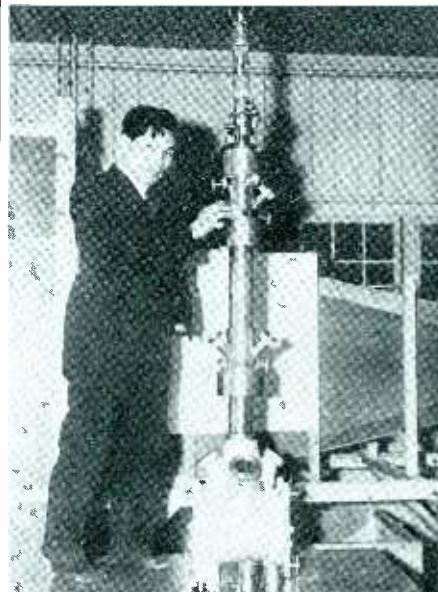

Prof. Sugata of the Osaka Technical College with the electron microscope which the College has recently acquired. The microscope is very similar in appearance to that developed by Ruska and his associates of the famous Siemens concern in Germany

**27-145 MEGACYCLE RANGE**  
(11.1-2.07 METERS)  
**AMPLITUDE/FREQUENCY MODULATION**



Model S-27 is the first general-coverage U.H.F. communications receiver to incorporate Frequency Modulation reception. Covers 3 bands: 27 to 46 mc; 45 to 84mc; 81 to 145mc. Switch changing from FM to AM reception. Acorn tubes in R.F. and newly developed converter system. High gain 1853 tubes in I.F. stages. Beam power tubes and 6C8G phase inverter in A.F. Amplifier. Limiter tube provides full limiter action on signals of approximately 5 to 10 microvolts in F.M. operation. 955 plate-tuned oscillator. I.F. selectivity automatically sharpened to receive amplitude modulated U.H.F. signals or broadened for wide band frequency modulated signals. Front panel controls: R.F. gain control. Band switch. Antenna trimmer. I.F. selectivity (air tuned iron core) control. Volume control. Pitch control. Tone control. S-meter adjustment (meter calibrated in S and DB units.) AVC switch. Beat oscillator switch. Automatic noise limiter switch. Amplitude/Frequency Modulation switch. Send-receive switch. Phone jack.

**the hallicrafters inc.**  
2607 SOUTH INDIANA AVENUE, CHICAGO, U. S. A.

WORLD'S LARGEST BUILDERS OF  
AMATEUR COMMUNICATIONS  
EQUIPMENT

*Get the best  
Answer quickly*

## TO YOUR PROBLEMS

in dial lights, cables,  
connectors, moldings

Typical answers to  
such problems of—

● A large radio set manufacturer needed a well insulated compact connector for a phonograph motor that would meet underwriters requirements for 110 volt duty.

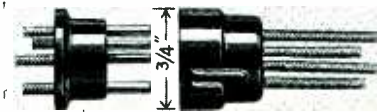

★ An Alden stock item type 502P and F supplied with leads met all their requirements and others which had not been anticipated at the time of the original request. P. A. This can also be supplied with three or four circuits.

● A wire communication requested a special dial lamp socket for a particular application where the number to be used was small.

★ Temporary tools were made and the small quantity ordered was shipped promptly. It later developed to a point where production quantities were ordered.

● A relay manufacturer required a base for mounting a sensitive relay to plug in an octal tube socket.



★ An Alden stock item type 108 plug was recommended and adopted. The customer was also advised that plugs of the same dimensions were also available in 4-5-6-7 prongs which were later adopted for other type relays.

● A radio set manufacturer making a combination radio-phonograph recorder set required a neat appearing shielded plug and socket for a microphone cable.



★ Alden supplied a stock grounding ring socket and shielded plug in an antique bronze finish complete with the shielded microphone cable.

If you have a problem involving wire assemblies, cables, connectors, dial lights, special moldings, or other small assembly, check our data sheets and then with the factory for the best possible solution.

Send for the latest information on television components.

**ALDEN PRODUCTS CO.**

714 Center St.

Brockton, Mass.

ceiving station established on Highgate Hill in 1938 as an alternative to reception at Alexandra Palace was put into general use. The signals received were conveyed from Highgate Hill to Alexandra Palace, the television broadcasting center, at vision frequency by the neighboring balanced pair television cable. The receiving aerial at Swains Lane, Highgate, was a two-element array half way up a mast of 250 feet, but experiments were begun with a rotatable receiving array for horizontally polarized waves with which a gain of about 10 db was anticipated.

Considerable progress was made in the design of the new Super-Emitron camera by Marconi—E.M.I. Experiments with a cathode ray type of view finder were most promising. This view finder consists of a small cathode ray tube fed directly from the scanning equipment. The camera man thus sees the picture in his camera as it is actually transmitted instead of on a small optical view finder as formerly.

During 1939 the British Broadcasting Corporation co-operated further with the Post Office and with the British Standards Institution on the subject of the electrical interference with radio reception and agreed standard specifications were issued by the B.S.I. on "Radio Interference Suppression for Automobiles and Stationary Internal-Combustion Engines" and "Radio In-

• • •

## STEAK GETS LIGHT ONCE-OVER



Placed in a grill between two 250-watt reflector type drying lamps, a prime cut of filet mignon sizzles as J. D. Hall, Westinghouse engineer at Bloomfield, N. J. times the operation. The steak was pronounced well done after nine minutes of exposure to the infra-red rays produced by the two lamps shown

## Balancing and Semi-Tuned Power Filters

*for all*

## POWER, IGNITION AND ANTENNA CIRCUITS

★ Units available for: Airplanes, airships, marine ships, fighting tanks, police radio, government and industrial research laboratories, colleges and many other uses.

Available in various capacities  
No shielding required  
Light in weight  
Easy to install  
Inexpensive  
Efficient

The Whisk patented glow-gaseous discharge tube combined with the balancing unit is designed to overcome electromagnetic and electrostatic disturbances as encountered in tropical countries.

## WHISK LABORATORIES

145 West 45th St., New York, N. Y.

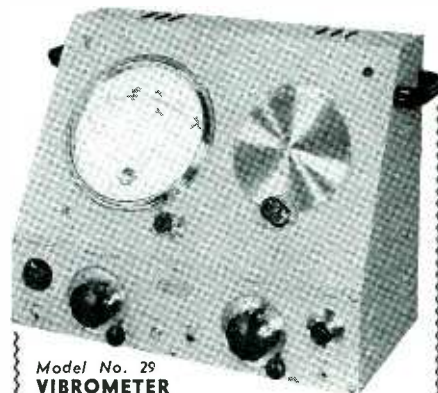

Model No. 25  
VIBROMETER

## INVALUABLE FOR DETERMINING VIBRATIONS

Used by leading machinery, aircraft and diesel engine builders. Colleges, laboratories and construction companies.

Model 29 unequalled for determining amplitude of vibration and frequency analysis. Measures amplitude of vibration in four ranges covering .0001 to 1".

Model 11 same as Model 29 except minus frequency analyzer, ruggedly built for factory use and production line. No calculations, direct calibration, only one control.

**NET** Model 29—\$290.00 F.O.B.  
Model 11—\$150.00 F.O.B.

Write for catalogue on other products.

## TELEVISIO Co.

1135 North Cicero Avenue  
CHICAGO U. S. A.



terference Suppression for Trolley-busses and Tramways". The previous specification for the "Limits of Radio Interference" was revised and re-issued. Attention was also directed to the problem of interference caused by electromedical equipment on short and ultra short wave lengths.

• • •

### Synchronism Indicator

THE APPLICATION OF a Cathode-ray tube circuit to the problem of synchronizing a 132,000-volt line to a bus, is described in an article entitled "Cathode Ray Type Synchronism Indicator," by Frederic S. Beale, in the March 1940 issue of *Instruments*. A type 6E5 tube is used and the circuit is shown in the accompanying diagram. The small size of this tube enables its installation to be made in the best position for observation by the operator. Also because of its small size it may be duplicated at other convenient points by connecting additional tubes in parallel with it.

In the diagram, the line *L* is synchronized to the bus by means of the switch *S*. To a phase conductor of the line a static collector wire is electrostatically coupled, and another static collector wire is similarly coupled to the corresponding phase conductor of the bus. The potential developed in each of the pickup wires is proportional to and of the same frequency as the potentials of the bus and line to which they are coupled. Before the switch can be closed the frequency and phase relation in the bus and in the line or in the pickup wire must be identical. During synchronism there is no difference of potential in these two pickup wires and therefore the adjustment is made such that the 6E5 target shows a green light pattern with only a thin black shadow. With the line of the bus out of step the thin line of shadow spreads out with a more or less rhythmic opening and closing motion. The 100,000-ohm resistor is set so that the shadow covers approximately a 90 degree sector of the circle.

The indication given by this instrument does not in itself show whether the incoming line has a frequency which is higher or lower than the bus to which it is to be connected. If this information is required it may be obtained by the addition of an amplifier tube to provide the power needed to operate the rotation indicating device.

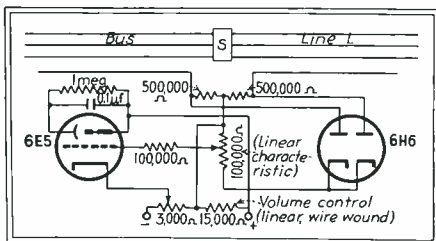

Circuit diagram of synchronism indicator for power lines

# LEADERSHIP!

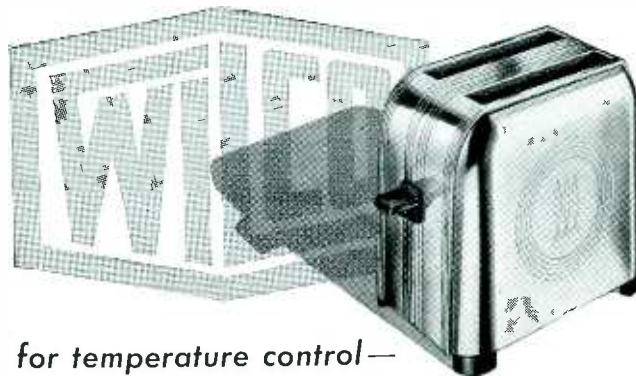

for temperature control—  
"TOASTMASTER" depends on WILCO

Puzzled over the proper contact materials for your product? Then do as the McGraw Electric Co. — Maker of "Toastmaster" Products — and thousands of other industrial leaders do. Consult with — Wilco pioneer in the development of scores of varying contact materials.

Benefit from 26 years of experience in the research, man-

ufacture and sale of every known kind of electrical contact. Utilize products that have proved their accuracy and reliability under every conceivable kind of laboratory and field test. Write for "Wilco Blue Book of Thermometals" — The H. A. Wilson Co., 105 Chestnut Street, Newark, N. J. Branch Off.: Detroit, Mich., & Chicago, Ill.

**WILCO ELECTRICAL CONTACTS**

PLATINUM... IRIIDIUM... SILVER... INLAY... OVERLAY... LAMINATED... TUNGSTEN

## WE FIT THEM TO YOUR JOB

... AND THAT'S HOW RELAY DEPENDABILITY IS ASSURED

There is one right way to buy relays; that is, to make sure they are designed right in the first place, then specifically adopted to your application. This is where Dunco comes into the picture in a big way. Backed with one of the largest lines of quality relays, timers, etc., and with years of practical experience in fitting them to the specific needs of leading users, Dunco engineers are in an enviable position to help you get the most for your relay dollars in terms of dependability and long, trouble-free performance.

Write for the Dunco Relay Book — free upon request

**STRUTHERS DUNN, Inc.**  
1326 Cherry Street, Phila., Pa.

**DUNCO RELAYS**

"Tailor-made" for Discriminating Users

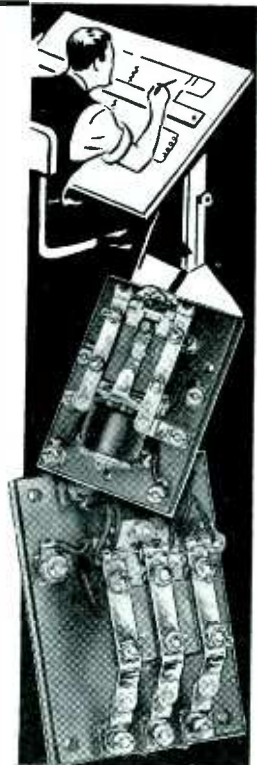

# NEW TRANSMISSION MEASURING SET

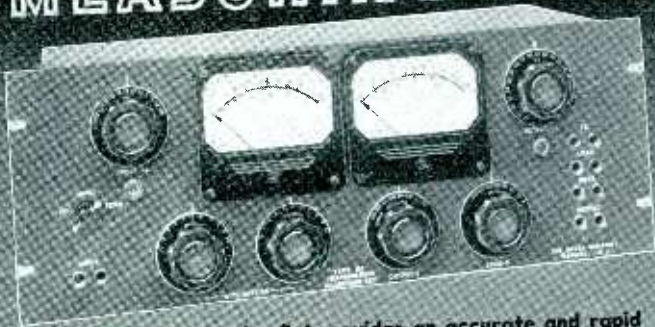

The Type 6C Measuring Set provides an accurate and rapid method for measuring the transmission characteristics of networks at audio frequencies.

This new set has the following outstanding features which contribute to its usefulness in the radio broadcasting field.

- \* REFERENCE LEVEL: New standard of 1 mw. in 600 ohms.
- \* METERS: New Type 30 standards.
- \* ATTENUATION RANGE: Zero to 110 db. in steps of 1 db.
- \* POWER RANGE: Calibrated from -16 to +45 db.
- \* FREQUENCY RANGE: 20 to 17,000 cycles.
- \* IMPEDANCES: Dial selection of useful network input and load impedances.
- \* MISMATCH ADDITIONS: No additions necessary for change of impedance.

TYPE 6C TRANSMISSION MEASURING SET... \$325.00

Write for additional technical information.

**THE DAVEN COMPANY**  
158 SUMMIT STREET NEWARK, NEW JERSEY

The Type 6C was developed in co-ordination with the engineering department of the Columbia Broadcasting System.



## Coaxial Loudspeakers

(Continued from page 35)

operator and be heard in the receivers.

The characteristics of the studio microphone are, of course, as important as those of the loudspeaker in determining the overall performance of a system. This obvious fact, however, is sometimes overlooked in passing judgment on a loudspeaker's rendition of broadcast reception. The layman's beautifully straightforward and simple theory that anything wrong with the sound must be the fault of the loudspeaker because that is where the sound comes from seems sometimes to be shared by those who are not so lay. However, considerable effort was spent on loudspeakers and circuits before it was fully realized that the reason for the devastating shrillness of the violins resided elsewhere.

There are probably still in use today many dynamic microphones of an older type whose field calibrations disclose peaks as large as 8 db in the high frequency range. Such irregularities cannot be dealt with successfully by electrical equalization because at least part of the high frequency rise is a function of the angle of incidence of sound upon the microphone. The presence of these defects is usually unsuspected when listening with ordinary radio receivers having a generally falling high frequency response and nearly complete cut off at 5000 cps. They are sometimes distressingly revealed, however, when one listens over an extended frequency range system known to be free from significant irregularities. When talkers of the type inelegantly but expressively characterized as "spitty", speak close to such a microphone the results over a high fidelity receiving system sometimes approach the absurdity of a "sound effect". Another type of talker appears to deliver a strong air current along with speech (no political references intended) which at close range produces eddies within or around some microphone structures and gives rise to a disturbing hissing and roaring accompaniment. At the other end of the frequency scale are the bass boosting effect of talking too close to an unequalized ribbon microphone and the

## SEARCHLIGHT SECTION

(Classified Advertising)

EMPLOYMENT : "OPPORTUNITIES" : EQUIPMENT  
BUSINESS : : USED OR RESALE

UNDISPLAYED — RATES — DISPLAYED

10 CENTS A WORD. MINIMUM CHARGE \$2.00  
Positions Wanted (full or part time salaried employment only) ½ the above rates payable in advance.  
Box Numbers—Care of publication New York, Chicago or San Francisco offices count as 10 words.  
Discount of 10% if full payment is made in advance for 4 consecutive insertions.

Individual Spaces with border rules for prominent display of advertisements.  
The advertising rate is \$6.00 per inch for all advertising appearing on other than a contract basis. Contract rates quoted on request.  
An advertising inch is measured 7/8" vertically on a column—3 columns—30 inches to a page.

### POSITION WANTED

RESPONSIBLE, well educated engineer, E. E. degree from leading university, 27, author Electronics article 1939, permanent shift from utility business to established manufacturer or broadcaster. Experienced in design, construction, installation and operation, broadcast and aircraft equipment. Location unimportant. PW-231, Electronics, 330 W. 42nd St., New York, N. Y.

### FOR SALE

General Radio and Leeds Northrup precision Laboratory apparatus for sale reasonable. For list write Oliver Riddel, 1332 Hood Avenue, Chicago.

### DEPENDABLE

#### Used ELECTRONIC TUBE EQUIPMENT

A complete line of used equipment for the manufacture of Radio Tubes, Neon Tubes, Incandescent Lamps, etc.  
Write for Bulletin showing savings from 25 to 75%  
KISLER ELECTRIC CORP.  
534 39th Street, Union City, N. J.

### HIGH GRADE USED

#### ELECTRON TUBE MACHINERY

Huge Stock of Every Type and Variety  
KAHLE ENGINEERING CORPORATION  
Specialists in Equipment for the manufacture of Neon Tubes, Radio Tubes, Incandescent Lamps, Photo Cells, X-ray Tubes, etc.  
900 DeMott St., North Bergen, N. J.

## YOUR ORGANIZATION

Is it complete?

Are you expanding it?

Making replacements?

Naturally, you are anxious to secure the most suitable man or men available. You want men with the special training that will make them an asset to your organization. You can contact such men through a Position Vacant advertisement in the Searchlight Section of ELECTRONICS

**EXPERIENCE  
ALONE  
DOES NOT  
ASSURE  
SUCCESS**



● Experience PLUS Technical Training Prepares You for Advancement in **RADIO & TELEVISION ENGINEERING**

Years of experience on a routine job does not in itself prepare a man for a more advanced position. Radio, Facsimile, Television — are offering constant new opportunities through new developments. But, experience alone cannot qualify you for a job that demands ability based on specialization and modern training. The better job that you want must be earned in your spare time. Hundreds of men in every branch of the radio industry are improving their knowledge and jobs by training in their spare time. CREI home-study courses prepare you for a definite career by backing up your experience with modern technical training.

Write for **FREE** New illustrated booklet "A Tested Plan for A Future in Radio"

In our effort to intelligently answer your inquiry — please state briefly your background, education and present position.

**CAPITOL RADIO ENGINEERING INSTITUTE**  
DEPT. E-4, 3224-16TH ST. N.W., WASH., D. C.



**MADE BETTER TO  
WORK BETTER**



● The combination of high tensile strength that assures a lasting bond, and faster, cleaner work made possible by quick-acting flux of pure water white rosin, has given Gardiner Rosin-Core Solders an outstanding reputation for efficiency and economy on radio work by expert or amateur. Yet, due to modern production methods and big sales, Gardiner Solders cost less than even ordinary kinds. Made in various alloys and core sizes . . . and in gauges as small as 1/32 of an inch . . . in 1, 5 and 20 lb. spools.



4889 S. Campbell Avenue Chicago, Ill.

carpet beater illusion produced by this same combination and a talker who bears down heavily on "puh".

There lately has been much improvement in available microphone characteristics. The miniature condenser microphone originally designed as a measuring tool some years ago by Harrison and Flanders' is now being used in commercial practice. Experience with this instrument in measurement work and as a sound pick-up in aural tests of loudspeakers has been very gratifying. When equipped with a small wind screen it can be used for close talking with none of the undesirable effects mentioned above. Later microphones of the uni-directional type also appear to offer possibilities of more natural overall results.

One does not realize how far studio conditions of sound pickup sometimes depart from those of usual direct audition until he has listened to a large number of different programs over a system of known high fidelity. One of the problems of microphone placement in the past appears to have been the difficulty of getting the violins in an orchestra to "come out" in the reproduction as afforded by ordinary loud speakers. Consequently, the tendency has been to place these instruments close to the microphone. Now, when we listen to such an arrangement over a truly high fidelity system, we are conscious of so much scraping and creaking noise accompanying the music that it may detract from appreciation of the extended frequency range. The explanation is connected with the fact that we seldom if ever listen to actual performances at as short distances as microphones are commonly placed. Nor are the bowed instruments the only offenders in this respect. Too often when listening to solo performances over wide range systems are we conscious of the breathing noises of singers or the clatter of the key mechanism of woodwind instruments or accordions. When the listening is done over ordinary receivers with their customarily restricted frequency range, the noises above referred to are usually not recognized because so many of their essential frequency components lie outside the receiving system range.

Noise leaking into studios and poor studio acoustics appear to be among the reasons for close-up



★ CLAROSTAT salutes ELECTRONICS on the occasion of its Tenth Anniversary. The past decade has meant rapid and steady progress for both. While ELECTRONICS has so ably chronicled radio and electronic developments, CLAROSTAT has been privileged to concentrate and specialize in supplying better and still better resistors, controls and resistance devices so essential to progress.



★ Today CLAROSTAT is supplying "Tougher than Ever" components. Greenohms, for example, have set new standards for power resistors, due to their unique and exclusive inorganic cement coating developed after years of search and research. ★ Just added to the line are CLAROSTAT Series HTA, HTAA, HTB and HTBB general-utility resistors. Many applications will be found for this new metal-enclosed utility resistor. Perforated metal housing. Legs for mounting on bench or panel. Four types: HTA, 75-watt male and female receptacles; HTAA, 150-watt male and female receptacles; HTB, 75-watt female receptacle and 3' extension cord; HTBB, 150-watt female receptacle and 3' extension cord.

**Submit that Problem . . .**



Our engineers will gladly collaborate in supplying proper units, application recommendations, specs., quotations. Be sure you have our loose-leaf engineering data. Copy on request.

**CLAROSTAT MFG. CO., Inc.**  
285-7 N. 6th St.  
Brooklyn, N. Y.



# RESISTOR PROBLEM?

*Let us help you solve it!*

● The many types of Global Ceramic Resistors are solving difficult resistance problems every day. Our competent staff of engineers are at your service without obligation.

When writing please include such information as—  
diagram of circuit, function of resistor, physical limitations and electrical specifications.

GLOBAR DIVISION  
THE CARBORUNDUM COMPANY, NIAGARA FALLS, N. Y.

REG. U. S. PAT. OFF.

(Carborundum and Globar are registered trade-marks of  
and indicate manufacture by The Carborundum Company)

*Global* CERAMIC RESISTORS  
TRADE



## PERMANENT MAGNETS

ALL SHAPES — ALL SIZES  
FOR ALL PURPOSES

Stamped, Formed, and Cast; Chrome, Tungsten, Cobalt and ALNICO\*\* (cast or sintered) under G. E. license.

**THOMAS & SKINNER**  
STEEL PRODUCTS COMPANY  
1116 E. 23rd STREET INDIANAPOLIS, INDIANA

Laminations for Radio Transformers — Tools  
Dies — Heat Treating — Stampings

38 YEARS EXPERIENCE

## WAXES • COMPOUNDS for ELECTRICAL INSULATION

Zophar offers prompt service on Insulating Compounds for a wide variety of electrical applications, including:

... Insulation for CONDENSERS, TRANSFORMERS, COILS, power packs, pot heads, sockets, wiring devices, wet and dry batteries, etc. Also WAX SATURATORS for braided wire and tape. WAXES for radio parts.  
Special compounds made to your order.

**ZOPHAR MILLS INC.**  
130-26th St. Brooklyn, N. Y.  
FOUNDED 1846

microphone placement. The first of these demands the close pick-up to secure a satisfactory signal to noise ratio. In addition, studio noise is by itself more troublesome when programs are received over wide frequency range systems because the noises are reproduced with such naturalness as to be readily identified and therefore distracting, as contrasted with the generally indeterminate character of such sounds when heard over ordinary radio equipment.

It is not suggested that microphones be placed at optimum direct listening distance regardless of experience and the well known monaural difference. It is believed, however, that more natural sounding pick-up for high fidelity reception requires working toward the maximum rather than toward the minimum distance and that conditions which prevent the attainment of this end should be rectified.

The effects complained of above are, in general, the exception rather than the rule. The reception of most local station programs, even those transmitted over wire networks with a 5000 cps cutoff, is much more enjoyable over a high fidelity receiver equipped with a loudspeaker system of the type described, because the overall response of such a receiver is substantially flat over a wide frequency range, whereas the ordinary "standard fidelity" receiver is not only well on its way out at 5000 cps, but its response is not smooth.

The full possibilities of a good high fidelity receiver can only be enjoyed on present conventional broadcasting when the program is picked up locally over wide band circuits and received at high field strength. Even small dance orchestras heard under these conditions appear to take on new life and percussion instruments whose presence ordinarily would be unsuspected can be identified. Large symphony orchestras are reproduced with a thrilling degree of realism. We may expect even greater realism with the increased dynamic range promised for frequency modulation transmission systems and made possible by their low noise level.

<sup>1</sup> *Jour. Acous. Soc. of Amer.*, Jan. 1931, p. 330.

<sup>2</sup> *Elec. Eng.*, Jan. 1934, p. 18.

<sup>3</sup> *Jour. Acous. Soc. of Amer.*, Oct. 1936, p. 104. *Electronics*, April 1937, p. 24.

<sup>4</sup> *Jour. Acous. Soc. of Amer.*, July 1932 (Supp.), p. 451.

# THE INDUSTRY IN REVIEW

## New Multi-Pattern Cardioid Microphone

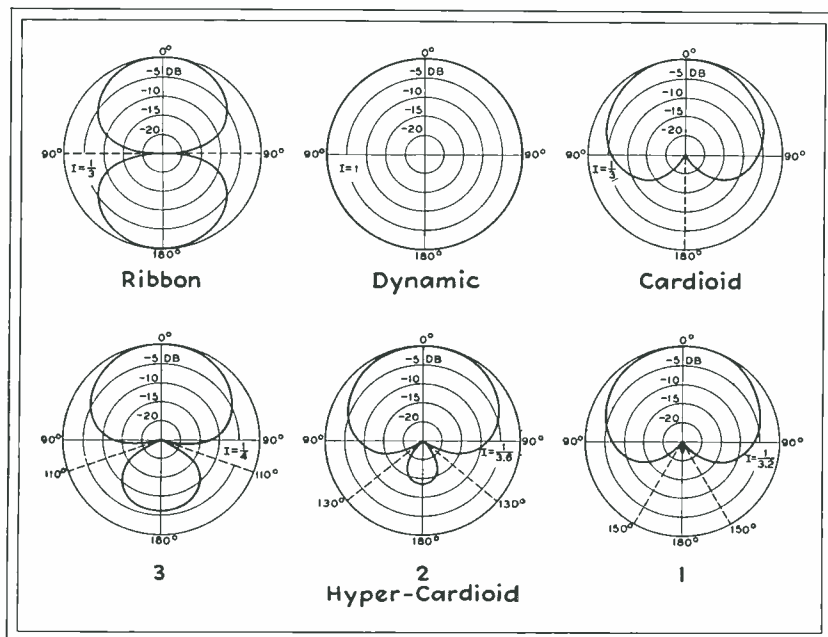

Response patterns available with the Western Electric Multi-Mike. The hyper-cardioid patterns are obtained by varying the attenuation of the dynamic unit relative to the ribbon unit

**A** NEW cardioid microphone, the Multimike (Type 639B) in which the response pattern is adjustable to the studio or auditorium conditions has recently been introduced by the Western Electric Co., 195 Broadway, New York. In addition to the three characteristics available with the original cardioid microphone, i.e., the non-directional, the bi-directional and the cardioid, the new instrument provides three new hyper-cardioid patterns, each with two areas of deadness extending radially from the rear of the Multimike. The desired pattern is obtained by means of a six position switch located on the rear of the casing and which changes the degree of attenuation of the output of the dynamic element. The accompanying diagram illustrates the shapes of the various patterns and indicates the dead spots in the three hyper-cardioids. The dead areas are actually dead volumes, that is, if they could be made visible, they would appear as cones of insensitivity radiating into space from the rear of the microphone.

The frequency range is from 40 to 10,000 cps and the output is minus 84 db referred to 1 volt per dyne per sq cm. The impedance is 30 ohms. The new instrument weighs 3 pounds and 4 ounces and its dimensions are  $7\frac{1}{2}$  inches high by  $3\frac{1}{8}$  inches wide by  $4\frac{1}{8}$  inches deep. It is finished in an aluminum gray color. There is available a complete line of desk, floor and

suspension stands and other accessories for quickly changing from one type of microphone to another without disconnecting the cord.

The usefulness of the new instrument is apparent in reverberent halls where the hollow sound usually associated



The usefulness of this microphone is greatly enhanced by its several types of response patterns

with such halls is reduced to a considerable degree. In public address work, use of the Multimike permits a material increase in the amplification before the system howls due to excessive feedback from the loudspeaker to the microphone. The increased amplification permissible with the use of the Multimike increases the maximum allowable distance from the microphone and permits the speakers or performers more freedom of motion. In public address work it is only necessary to point the dead spot of the microphone at the loudspeakers to reduce the feedback. In studios which are not completely sound treated, the dead spots are pointed at the sources of echo to reduce the undesired reverberation.

As the response pattern of the microphone is advanced through its various phases, an increasing discrimination against random reverberation is noted. This effect is at a maximum in hyper-cardioid pattern No. 3, as shown in the diagram. This is the case because the directivity characteristic changes as the response pattern changes. In position 3, the sensitivity to sound from the front exceeds the average sensitivity from all directions by four times. Therefore, sound directly from the front of the microphone is favored by a factor of four to one over sounds reflected from random points throughout the room.

## News

♦ The new \$700,000 studio and laboratory annex of Columbia Broadcasting Company, New York City, is scheduled to open on May 15th. The annex will house seven studios, in which will be embodied every technical advance and innovations for improvement in quality of sound definition . . . A new engineering department devoted to the general commercial design and production of radio apparatus of all types, and associated products has been created by the Radio Division, Westinghouse Electric & Manufacturing Company at Baltimore, Md. This new department will be known as the Special Apparatus Engineering Section and will be under the direction of Ralph N. Harmon . . . A special design service on radio coils is being offered to radio engineers, experimenters and firms having use of a single, or many coils. Barber &

# ELECTRONIC CLARE RELAYS INDUSTRIAL



Evidence of the value of CLARE Service and the quality of CLARE Relays is the list of prominent manufacturers and users who are regular buyers of CLARE Individualized Relays.

We respectfully solicit your inquiry.

CLARE Individualized Relays are designed to your specifications.

- \*Coils—from a fraction ohm to 40,000 ohms—marked.
- \*Contact Assemblies—makes—breaks—break-make—make before breaks—break-make before breaks and combinations of these.
- \*Contacts—precision metals.
- \*Residual—screw adjustable or welded fixed.
- \*Adjustment—standard or to special specifications.
- \*Mountings—individual or group mounting accessories.
- \*Service—delivery to meet your schedules.

**C. P. CLARE & CO.**  
LAWRENCE & LAMON AVES. - CHICAGO  
15 EAST 26TH STREET. NEW YORK CITY



Type 105 . . . . .

## MICROMETER FREQUENCY METER

. . . a heterodyne-type, band-spread, AC-operated instrument with precision crystal calibrator.

- Will measure any transmitter, on any frequency, up to 56 mc.
- One crystal calibrator suffices for all transmitters.
- Percentage deviation calibration for each channel.
- Accuracy better than 0.01%.
- Price, \$135.00, net, including crystal.

— Write for further details —

**LAMPKIN LABORATORIES, BRADENTON, FLA.**

## NEW SUPER HI-POWER GENEMOTOR for Heavy Duty Service



150 Watt, Weight 13½ lbs.  
8½" Long, 4½" Wide, 5" High

Sets a new high standard for Power Units used on Marine, Police, and Aircraft Radio. The exceptional Hi Efficiency, small size, and light weight are the result of a new type, one piece field ring, and armature design. Grease packed ball bearings require no oiling or attention. Double enamel and silk wire on armature insure trouble-free operation; end dust cover removable. Made in two sizes, 150 and 225 watt output, up to 1000 volts, input 5.5 volt and up.

There is a Carter Genemotor or Converter for every requirement. Write for further information

**CARTER MOTOR CO.**

1606 MILWAUKEE AVENUE

CHICAGO, ILLINOIS

Howard, East Ave., Westerly, Rhode Island, manufacturers of i-f, r-f, and oscillator coils and coil winders will be glad to assist by designing coils suitable to be used in radio equipment, custom built sets, radio direction finders, etc. Rewinding of defective coils or duplication of any coils needed is included in their services . . . The Hewlett-Packard Company is moving from its old quarters at 367 Addison Avenue to new and larger quarters at 481 Page Mill Road, Palo Alto, Cal. . . . The Canadian Research Institute have moved their laboratories to larger quarters at 463 Spadina Ave., Toronto, Canada. They will also increase their staff . . . The offices, laboratory and factory of Radio Development & Research Corp., will now be located at 136 West 52nd St., New York City . . . Elastic Stop Nut Corp., Elizabeth, N. J. is building a new plant on Vauxhall Road, Union, N. J. which is to be used solely for the manufacture of the corporation's extensive line of self-locking nuts . . . Stromberg-Carlson Telephone Mfg. Co., has made several organizational changes. Succeeding the late George A. Scoville as Vice President and General Manager is Dr. Ray H. Manson. Fred C. Young now becomes Chief Engineer and succeeds Dr. Manson in active charge of the engineering forces . . . Dr. Jesse T. Littleton has been promoted by Corning Glass Works to the new position of Assistant Research Director of that Company . . . The Annual joint meeting of the Institute of Radio Engineers and the American Section of the International Scientific Radio Union will be held on April 26th at the National Academy of Sciences, Washington, D. C. The program of abstracts will be available about April 15th.

## Literature

F-M Transmitters. Radio Engineering Laboratories, Inc., (35-54 36th Street, Long Island City, N. Y.) have a booklet (No. 259) available which illustrates and contains information on their frequency modulation transmitters suitable for high fidelity purposes.

Mobile Equipment. A four page bulletin contains specifications and illustrations of the following products of Kaar Engineering Co., Palo Alto, Cal.: Two-way police radiotelephone for mobile service, uhf police radio transmitter, uhf police radio receiver, and two-way police radio.

Aero-Thread Screw System. Bulletin T-1 contains engineering standards and technical information on Aero-Thread screws, studs, bolts, tapped holes and nuts. Manufacturers who use magnesium and aluminum castings and forgings will be interested. Aircraft Screw Products Co., 25-12 41st Ave., Long Island City, N. Y.



**we live in two worlds**  
FOR YOUR CONVENIENCE

If you're hunting for some radio part that "went out" with the gas light, it's ten to one we've got it. Or if your heart belongs to the Radio World of Tomorrow, it's an even safer bet we can help you there. We live in two worlds and the thousands of items in our regular stock reflect the whole history of Radio. We've placed the emphasis, of course, on today's demands, but when we say, "everything in radio", we mean it. Send for catalog No. 78 and see. It's **FREE**.

*Radio Wire Television Inc.*

**LAFAYETTE RADIO**

NEW YORK 100 Sixth Avenue  
CHICAGO 201 W. Jackson Blvd.  
ATLANTA 285 Peachtree St.  
BOSTON 110 Federal St.  
NEWARK 24 Central Ave.  
JAMAICA, L.I. 11-35 189th St.  
BRONX, N. Y. 342 E. Fordham Rd.

Precision Resistor Company

**MICROHM**  
WIRE WOUND RESISTORS

*A Preferred Product*

**OUTSTANDING CONCERNS**

REPEAT and REPEAT  
AGAIN and AGAIN

THEIR PURCHASES OF

**MICROHM**  
**RESISTORS**

Continued Preference is  
Best Proof of Uniform,  
Constant, Dependable  
**QUALITY**

*Complete service and advice  
on any and all of your resist-  
ance and equipment problems.*

Precision Resistor Company

334 BADGER AVENUE • NEWARK, N. J.

**Tube Service Manual.** Extensive and up to date information is contained in a 32-page "Plug-In Resistor Tube Service Manual" available for 15 cents from Clarostat Mfg. Co., 287 N. 6th St., Brooklyn, N. Y.

**Blue Ribbon Resistors.** Blue Ribbon resistors make a departure from the conventional tubular type of resistors. A one page bulletin illustrates and describes this new product of Hardwick, Hindle, Inc., Newark, N. J.

**Bulletins.** Several new bulletins available from Shallcross Mfg. Co., 10 Jackson Ave., Collingdale, Pa., are as follows: Bulletin 146-1 describes resistance standards, decade boxes, and special parts for electrical measurement. Bulletin 146-2 contains a number of unique bridges which are convenient for measuring d-c resistance, high and low resistance, conductivity, etc.; and bulletin 146-3 announces a large number of test sets and special apparatus used in electrical measuring, particularly in different phases of industrial work, electrical laboratories, etc.

**Silver Brazing Alloys.** Comprehensive information on the use of silver brazing alloys for joining metals in the marine field are contained in a reprint available from Handy & Harman, 82 Fulton St., New York City.

**Cinaudagraph Speakers.** A 4-page bulletin which contains quite a few illustrations and other information on Cinaudagraph speakers is available from United Teletone Corp., 150 Varick St., New York City.

**Cetron Photocell.** Type CE-23, a general purpose photocell is illustrated and described in a bulletin available from Continental Electric Co., Geneva, Ill. Another bulletin contains price schedules on various types of Cetron phototubes. A third bulletin contains simple photocell circuits.

**Time Delay Relay.** Bulletin F-2 describes the new synchronous motor driven time delay relay manufactured by R. W. Cramer Co., Centerbrook, Conn. The bulletin tells what this relay does, its uses, design, construction, etc.

**Phonograph Needles.** The Fidelitytone phonograph needle recently developed by Permo Products Corp., (6415 Ravenswood Ave., Chicago), is described in a bulletin recently issued by them.

**This is  
the book  
you have  
been waiting  
for . . . .**

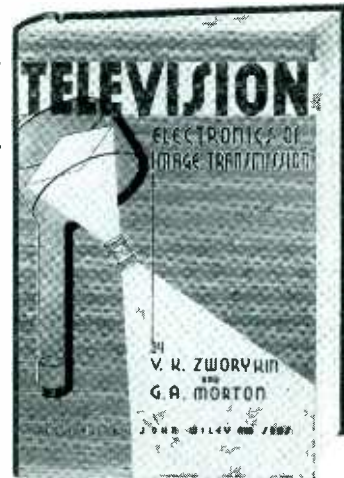

**TELEVISION**

**THE ELECTRONICS OF  
IMAGE TRANSMISSION**

By **V. K. ZWORYKIN**  
and **G. A. MORTON**

**RCA Manufacturing Company**

From two men well known in the field comes a book on this newest of practical means of communication. Authoritative, well organized, written in direct, clear-cut English, this volume brings to radio and communication engineers, television engineers and service men more than six hundred pages of much needed factual material. The first part of the book is devoted to a consideration of the fundamental physical phenomena involved in television—emission of electrons, electron optics and fluorescent materials. This is followed by analyses of fundamentals of picture transmission and resolution; various forms of electronic terminal tubes used in television; problems of video amplification, radio transmission and reception, etc. One of the most important sections of the book is the concluding one, in which the RCA-NBC television project is described.

FEBRUARY 1940  
646 pages; 6 by 9; 494 illustrations  
\$6.00

**ON APPROVAL AND SON**

**JOHN WILEY & SONS, INC.**  
440 Fourth Avenue, New York, N. Y.  
Please send me a copy of ZWORYKIN AND MORTON'S TELEVISION on ten days' approval. At the end of that time, if I decide to keep the book I will remit \$6.00 plus postage; otherwise I will return the book postpaid.

Name .....  
Address .....  
City and State .....  
Employed by .....

E 4-40

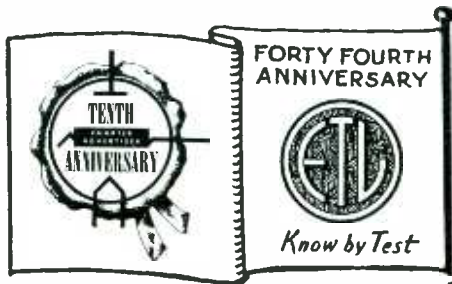

## Services here for all readers of "electronics"



The New E.T.L. Building

### 1. PRIVATE LABORATORIES

Frequently engineers desire to develop a product under conditions of privacy. Here private quarters are available with access to E.T.L. facilities.

### 2. COOPERATION WITH LABS.

Manufacturers' laboratories may extend their scope by utilizing some of E.T.L.'s complete equipment—or by checking their instruments against standards at E.T.L.

### 3. PHOTOMETRIC WORK

Calibration of photo-electric cells. Spectral, current-voltage and current light response curves.

### 4. CHEMICAL TESTS

Tissues, waxes, steels, varnishes, conductor insulations.

### 5. MECHANICAL TESTS

Tensile, compression, hardness tests of materials; elongation tests; impact tests; strain tests.

### 6. ELECTRICAL TESTS

Life tests, resistivity, power factor, dielectric, etc. of all materials in electrical apparatus.

### 7. SPACE RENTAL

Two upper floors of the new building are available for organizations requiring access to testing facilities.

WRITE FOR BOOKLET  
DETAILING SERVICES  
TO HELP YOUR WORK

Know by Test—at



## New Products

### Transformers

THE KENYON TRANSFORMER Co., 840 Barry Street, New York City, have announced a complete new series of transformers made in both standard and submersion proof types. They are designed to plug into an 11-prong octal socket and are neat in appearance. Units are manufactured in the following types: line to line, crystal mike to

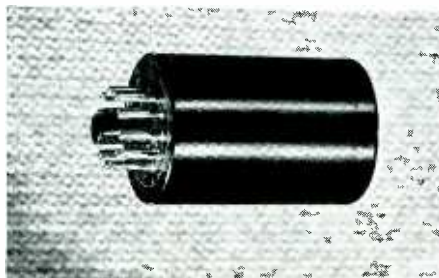

line, low impedance source to grid, interstage transformer, and output transformers and chokes. With no dc in the winding the frequency response is plus or minus 2 db 30 to 20,000 cps. These units will find application in light portable equipment, such as aircraft, broadcasting, marine, or any other service where government specifications for submersion proof testing are to be maintained.

• • •

### W2XOR FM TRANSMITTER



At WOR this frequency modulation transmitter, installed by Radio Engineering Laboratories, Inc., has been in operation for several weeks

### Photoelectric Colorimeter

SEVERAL TYPES OF Lumetron photoelectric colorimeters are available from Photovolt Corp., Dr. F. Loewenberg, 10 East 40th St., New York City. Model KI-401 is for use in general colorimetric and turbidimetric determinations. The unit is suited for sample holders up to 1 inch. It is self-contained with built-in pointer type galvanometer; Model KI-402 is for accurate measurement of extremely transparent liquids. Suited for sample holders up to 6 ins., and has an external point type galvanometer; Model KI-401E is for use with monochromatic filters (abridged spectrophotometry). Suited for sample holders up to 1 inch and has an external mirror type galvanometer; and Model KI-402E, for use with monochromatic filters and for accurate measurement of extremely transparent liquids. Suited for sample holders up to 6 ins. External mirror type galvanometer.

These colorimeters are useful for opacity determinations on paper and other translucent materials, transmission measurements on glass and other transparent products, reflection tests on surfaces, Tyndall effect measurements, and measurements with mercury-vapor light source. They operate on 110-120 volt, 60 cycle ac, for 220-240 volts, for 25 cycles and for dc.

A bulletin is available which contains complete information.

### New Audio Filter Unit

P. R. MALLORY & Co., INC., Indianapolis, Ind., announce a new audio or hum filter unit, the Mallory VF-223, which is now available for use with all single unit Mallory Vibrapacks. It was designed especially for application where voltage regulation is important, as in Class "B" audio amplification; or where the utmost in hum suppression is required as in high gain audio amplifiers.

The filter condenser is a three-section Mallory FPT-390, of 15-15-10  $\mu$ f capacity, 450 working volts. The two 15  $\mu$ f sections are used with the choke to form a conventional pi-section filter, while the third 10  $\mu$ f section connects to a separate terminal so that, if desired, a filtered intermediate output voltage may be obtained. The filter choke is rated at 100 ma. and has a d-c resistance of only 90 ohms, resulting in a minimum of voltage drop.

### Capacitors

CORNELL-DUBILIER Electric Corp., S. Plainfield, N. J., announce Type TK Dykanol capacitors for high voltage transmitter applications. The d-c working voltages range from 6000 to 25,000 in a wide range of capacity values.

Also available from C-D are a wide variety of mica capacitors for low-power transmitter application in the Types 4 and 9 Moulded Mica units. They were designed for transmitter manufacturers and amateurs.



**AS IN 1930-**

**In 1906 - -**

De Forest, working in the realm of physics, invented the vacuum tube. Acheson, meanwhile, laboring in the field of chemistry, first produced Colloidal Graphite.

It is fitting that these two products, born simultaneously, are, after a quarter of a century, intimately associated in the radio industry.

Colloidal Graphite is indispensable in the efficient drawing of tungsten and molybdenum. It discourages grid emission and finds utility as a "getter."

Colloidal Graphite is also a valuable resistance material for grid leaks and volume controls and serves as a long life lubricant for variable condensers and other moving radio parts.

**ACHESON OILDAG CO.**  
Manufacturers of "Aquadag" and "Oildag" brands of Colloidal Graphite.  
PORT HURON, MICH.

**TENTH ANNIVERSARY**  
REPRODUCTION OF FIRST ADVERTISEMENT  
**- SO IN 1940**

**"dag" COLLOIDAL GRAPHITE CONTRIBUTES TO PROGRESS OF THE INDUSTRY**

The versatile graphite films established with the use of "dag" have been employed in many ways in the fields of RADIO and ELECTRONICS.

Colloidal graphite imparts to the surfaces of innumerable bodies properties of lubricating, conductive, absorptive, pigmentary and reflective value. This product is used to advantage in the following: resistances, vacuum tubes, test specimens, thermopiles, evacuated devices, cathode ray tubes, photoelectric cells.

Write for Bulletins 11, 31, 191 and 270 describing how the product functions and how to use it. Perhaps "dag" will be an answer to problems which you may have.

**ACHESON COLLOIDS CORPORATION**  
PORT HURON, MICHIGAN



**Trumpets and Driver Units**

A NEW LINE of storm-proof Dynamic Reflect Trumpets and Driver Units are announced by Atlas Sound Corp., 1447-51 39th Street, Brooklyn, N. Y. The model illustrated has a six foot air column, bell opening of 29 inches, total depth (including unit and cover) of 31 inches. The new line includes trumpets and units of various sizes to



suit all types of public address applications. The permanent magnet type driver unit is completely enclosed and covered with a streamlined outer shell. The multi-adjustable cast mounting brackets are supplied as complete equipment.

**Type K Motor**

THIS NEW MOTOR is small in size 2 3/8 x 2 3/8 x 1 1/8 in. excluding the 5/8-inch long shaft. It weighs less than 1 1/2 lbs. Designed as a capacitor motor, it can be supplied with three different windings—synchronous capacitor, nonsynchronous capacitor, and dynamic braking capacitor. Standard ratings on 60 cycles are, respectively, 1/1500 hp at 1800 rpm, 1/1000 hp at 1700 rpm, and 1/1500 hp at 1200 rpm. Motor input is 8 watts or less.

Operation is at 110 volts ac, and motors wound for lower voltages can be built on order. On higher voltages a transformer is necessary. Motors for lower frequencies can be supplied. Sleeve bearings are standard, ball bearings optional. Principal use is on devices designed for continuous operation, such as industrial controllers, instruments, timers, and similar applications. Bulletin 1024 illustrates and describes in detail this motor which is manufactured by Bodine Electric Co., 2254 W. Ohio St., Chicago.

**Attenuator and Conversion Resistors**

A DISTORTIONLESS means of controlling the volume of individual loud-speakers in a sound system, is provided by the new Series CIB output attenuator released by Clarostat Mfg. Co., Inc., 285 North 6th St., Brooklyn, N. Y. Capable of dissipating 10 watts at any setting, this unit is a junior version of the

**New 7-INCH PORTABLES with extra long scale**

**FOR LABORATORY, COMMERCIAL AND INDUSTRIAL TESTING**



- 7-Inch Instrument with 6-Inch Scale.
- Standard and Special Ranges.
- Mirror Scale.
- Oak Carrying Case with Detachable Cover.
- Accurate to 1/2%. AC and DC Voltmeters — Ammeters with standard or special sensitivities.

MODELS 725-735 Portables may be obtained in standard and special ranges, including instruments of extreme sensitivity for laboratory use—as well as those for general commercial and industrial testing purposes. The large 7-inch instrument has a long six-inch mirror scale, maximum dial opening, and knife-edge pointer to assure quick accurate readings. Accuracy within 1% (1/2% for many ranges). Available in microammeters, milliammeters, ammeters, voltmeters, millivoltmeters, thermo-ammeters—multiple or single ranges. Case is quarter-sawed golden oak, 11" x 9" x 4", with handle and detachable cover. Black bakelite panel.

**Pocket Size VOLT-OHM-MILLIAMMETER**

A complete pocket-size Volt - Ohm - Milliammeter with AC-DC Voltage ranges: 0-10-50-250-500-1000 at 1000 ohms per volt; DC Milliampers 0-1-10-50-250; Low Ohms, 1/2 to 300; High Ohms to 250,000 with provisions for higher readings by external batteries . . . Molded case and panel.



MODEL 666  
Dealer Net Price...\$14.00

**WRITE FOR CATALOG**  
Section 234 Harmon Drive

**THE TRIPLET ELECTRICAL INSTRUMENT CO.**  
Bluffton, Ohio

## Consider the Safety Angle

IN MEASURING HIGH POTENTIALS

### Use the **SHALLCROSS** PORTABLE KILOVOLT METER



You'll find this not only a practical and inexpensive instrument but one with an unusually high safety factor as well. A compact, relatively small unit that can be portable or permanently installed. Separate multipliers can be furnished for a wide variety of standard instruments used for measuring potentials up to 25,000 volts A.C. or D.C.

Not affected by humidity. Easily adapted for use as resistance standards, particularly those multipliers for use with low current instruments requiring high resistance.

#### SHALLCROSS "AKRA-OHM" RESISTORS

Type 110—are used in this box, and there are none finer. Calibrated to an accuracy of 0.1 of 1%. Wound with specially insulated resistance wire on precision machined forms made of the finest grade of non-hygroscopic ceramic material available. Moisture proof. *They hold their calibration!*

Write for Kilovoltmeter Bulletin No. 700 KL and Resistor Bulletin No. 122 K2

**SHALLCROSS MFG. CO.**  
Instruments — Resistors — Switches  
**COLLINGDALE, PA.**

25-watt Series CIA attenuator. With neat and compact, one-hole mounting, round black-and-silver etched dial, pointer knob, this unit may be installed in power amplifier or at the individual speaker. Insertion loss is below zero. Db range is in 3 db steps up to 24, and then a 6 db step, with final step to infinity. Stock ohmages are 8, 15, 50, 200, 250 and 500 ohms. These units do not come equipped with power switches. Also available are fluorescent lamp d-c conversion resistors for inclusion in the power circuit of fluorescent lamps.

#### Timers and Relays

PARAGON ELECTRIC Co., 37 W. Van Buren St., Chicago, have a new series of automatic reset timers and time delay relays designed for precise and economic control of industrial operations. They can be used to close and then reopen a circuit, to open and re-



close a circuit, to make a momentary contact, to repeat a preset schedule of momentary contacts or timed "on" and "off" operations and to reset instantaneously after a power failure. A positive mechanical lock, magnetically operated, eliminates all friction and magnetic clutches and frees the timer of any disconnect due to vibration.

#### Communications Receivers

TWO NEW COMMUNICATIONS receivers are available. The first is a new radio receiver designed by RCA Mfg. Co. (Camden, N. J.) to provide maximum performance for amateur radio communication, and to find use wherever a radio receiver is required for distant reception. The 10-tube instrument (Model AR-77) has many new features including new treatment of the dials, dual r-f alignment, negative feedback, calibrated bandspread, improved noise limiter, and variable selectivity. The metal cabinet was designed with an eye to convenience of operation and ease of maintenance. An 8 inch permanent magnet dynamic loudspeaker is available for use with the receiver.

Hallcrafters Inc., 2611 S. Indiana

#### New

The Library now comprises a revised selection of books culled from leading McGraw-Hill publications in the radio field.



## McGraw-Hill RADIO ENGINEERING LIBRARY

— especially selected by radio specialists of McGraw-Hill publications

— to give most complete, dependable coverage of facts needed by all whose fields are grounded on radio fundamentals.

— available at a special price and terms

These books cover circuit phenomena, tube theory, networks, measurements, and other subjects—give specialized treatment of all fields of practical design and application. They are books of recognized position in the literature—books you will refer to and be referred to often. If you are a researcher or experimenter—if your interest in radio is deep-set and based on a real desire to go further in this field—you want these books for the help they give in hundreds of problems throughout the whole field of radio engineering.

5 volumes 3319 pages, 2298 illustrations

1. Eastman's FUNDAMENTALS OF VACUUM TUBES
2. Terman's RADIO ENGINEERING
3. Everitt's COMMUNICATION ENGINEERING
4. Hund's HIGH-FREQUENCY MEASUREMENTS
5. Henney's RADIO ENGINEERING HANDBOOK

Special Low Price and Easy Terms

Bought singly, the five volumes comprising this library would cost you more. Under this offer you save money and, in addition, have the privilege of paying in easy installments, beginning with \$2.50, 10 days after receipt of the books, and \$3.00 monthly thereafter. Already these books are recognized as standard works that you are bound to require sooner or later. Take advantage of these convenient terms to add them to your library now.

SEND THIS ON APPROVAL COUPON

McGraw-Hill Book Co., Inc.  
330 W. 42nd St., New York, N. Y.

Send me the McGraw-Hill Radio Engineering Library 5 vols., for 10 days' examination on approval. In 10 days I will send \$2.50, plus few cents postage, and \$3.00 monthly till \$23.50 is paid, or return books postpaid. (We pay postage on orders accompanied by remittance of first installment.)

Name .....

Address .....

City and State .....

Position .....

Company ..... L-4-40

(Books sent on approval in U. S. and Canada only.)

April 1940 — ELECTRONICS

**FOR RADIO COMMUNICATIONS ENGINEERS**

*Heavy Duty*  
**MICA CONDENSERS**  
*with Ultra Low-Loss Containers*



CAST ALUMINUM END PLATES FIT STANDARD MTG. DIMENSIONS

**T**HESE exceptionally high-grade condensers—with India Ruby mica—are built for long life, high current carrying capacities, and low losses. Available for prompt delivery in standard ratings. Write for structural data and prices.

**SANGAMO ELECTRIC COMPANY**  
SPRINGFIELD ILLINOIS

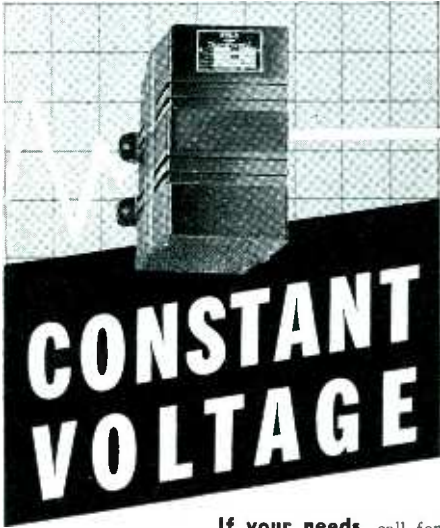

**CONSTANT VOLTAGE**

If your needs call for stable voltage at all times you can depend on SOLA CONSTANT VOLTAGE TRANSFORMERS to deliver for you, even though the incoming line voltage varies as much as thirty percent. Practical, economical, trouble-free—they can replace non-regulating transformers or perform as auxiliaries to equipment now in use.



WRITE FOR CATALOG  
DCV-22

**SOLA**  
SOLA ELECTRIC CO. 2525 Clybourn Chicago, Illinois

Ave., Chicago, announce their new SX-25 "Super Defiant" receiver, also in the medium priced range. Among some of the features of this receiver are two preselector stages, 4 degrees of selectivity including broad and sharp crystal filter circuits, temperature and line voltage compensation with freedom from tuning drifts, frequency calibrated bandspread on ham bands from 80 to 100 meters, automatic noise limiting, single signal CW reception, a continuous range of 538 kc to 42 Mc in four bands, "S" meter calibrated in "S" units and db, a 6-position switch for selecting phone or CW reception, etc. The circuit employs 12 tubes in r-f stages, mixer-oscillator, 2 i-f stages, detector avc-1st audio, noise limiter, bfo, phase inverter, push-pull output, and rectifier circuits.

**Vacuum Thermocouple Meter**

IN MODEL 43 POWER output meter of Monarch Mfg. Co., (3341 Belmont Ave., Chicago), a protective circuit has been incorporated which retains all of the desirable features of the vacuum thermocouple and in addition has the ruggedness and high overload capacity of the copper oxide type of rectifier meter. The meter is a Weston model 640 with a long scale (3½ inches) and open readings over its entire length. The instrument includes means for varying the input impedance between the limits of 3 ohms and 25,000 ohms. This is accomplished by means of a large transformer having suitable taps on its windings. Individually adjusted resistors are connected to all secondary taps to maintain a constant transformer efficiency regardless of which tap is in use. It is possible to determine the output impedance of the source supplying the instrument by varying the impedance of the instrument until the maximum power reading is obtained.

The secondary of the transformer feeds into a ladder type of attenuator network which gives seven power ranges: .03, 1, .3, 1, 3, 10 and 30 watts.

**Two-way Speaker System**

LANSING MFG. CO., announces that the Iconic System is now available in a new modern console cabinet which is heavily-built and acoustically correct. Measurements are 34x36-ins and it was designed for use in fine residential installations, hotels, cafes, schools, sound studios, etc. Literature on the system is available from the manufacturers located at 6900 McKinley Ave., Los Angeles, Cal.

**Universal Meter**

AN ALL-PURPOSE portable multi-meter for engineers, television technicians, industrial electricians, etc., is announced by the Radio City Products Co., 88 Park Place, New York City. Model P 411 Super Tester has a full array of

**RANGES ACCURACY VALUE DEPENDABILITY, VERSATILITY**

**PRECISION**  
*Laboratory Test Equipment*



**No. 852 Super Sensitive Tester**

Designed to meet the requirements of Television, Radio, Industrial and Laboratory.

**20,000 OHMS per Volt D.C.**

- ★Seven DC voltage ranges to 5000 v.
  - ★Seven AC voltage ranges to 5000 v.
  - ★Eight DC current ranges 0-30 microamperes to 0.10 AMPS
  - ★Three resistance ranges to 40 meg-ohms (self contained)
  - ★Seven decibel ranges from -12 to +69DB
  - ★Seven output ranges to 5000 volts
  - ★50 microamperes, 4% inch square type meter with cobalt magnet 2% D.C.—3% A.C. accuracy
- 852-P—Closed type with removable cover and tool compartment.. **\$41.95**



**Series 844 34 RANGE**  
**AC-DC Volt-Ohm-Decibel-**  
**Milliammeter**

**6000 Volts, AC-DC; 10 Megohms; 12 Amperes**

- ★Six AC and DC voltage ranges to 6000 volts at 1000 ohms per volt
  - ★Six DC current ranges to 12 AMPS
  - ★Four resistance ranges to 10 meg-ohms
  - ★Six decibel ranges from -12 to +70 DB
  - ★400 microamperes, 4% inch square type meter 2% D.C., 3% A.C. accuracy
- 844-P—Closed type with removable cover and tool compartment.. **\$24.95**

More than 40 models in the PRECISION 1940 LINE . . . 15 Mutual Conductance Tube Tester and Set Tester models ranging in price from as low as \$29.95 . . . 16 Multi-Range Tester models from as low as \$10.95 . . . Signal Generators from \$24.95, etc. . . . See them at your local distributor . . . Ask for the Precision Test Equipment 1940 Catalog

**PRECISION TEST EQUIPMENT**  
Standard of Accuracy SEE THEM AT YOUR JOBBER

**PRECISION APPARATUS COMPANY**  
647 Kent Avenue Brooklyn, New York  
Export Div.: 458 Broadway, New York, U. S. A.  
Cables: Morhanex

# CONTACTS

FOR THE FIELD OF ELECTRONICS

## B-L RECTIFIERS



CHANGE AC TO DC  
WITHOUT MOVING  
PARTS, GLASS BULBS,  
LIQUIDS, OR SPARK-  
ING CONTACTS.

DRY—DURABLE  
COMPACT—ECONOMICAL  
SPECIAL RECTIFIERS  
AND  
COMPLETE ASSEMBLIES

**THE BENWOOD LINZE CO.**

ST. LOUIS, MO.  
ELECTRICAL RECTIFIERS  
MANUFACTURERS ENGINEERS

With Offices in 80 Cities

## GRAYBAR ELECTRIC COMPANY

DISTRIBUTES HIGH GRADE KIRKLAND PILOT-LIGHTS

To manufacturers of high grade apparatus, who cannot afford to be judged by the standards of the retail bargain counters. Underwriter's Approved Units in three lens sizes, 2", 1 1/16", 11/16", for Tungsten or Neon lamps.

WRITE FOR TEN PAGE CATALOGUE  
MFGD BY H. R. KIRKLAND CO., MORRISTOWN, N. J.



### We manufacture a complete line of equipment

SPOT WELDERS, electric, from 1/4 to 500 KVA  
TRANSFORMERS, special and standard types  
INCANDESCENT LAMP manufacturing equipment  
RADIO TUBES, ex-ray, cathode ray, photo cells  
ELECTRONIC EQUIPMENT, vacuum pumps, etc.  
TUNGSTEN SLUGS, rod and wire manufacturing equipment  
GENERAL GLASS working machines and burners  
COLLEGE GLASS working units for students and laboratory

**EISLER ENGINEERING COMPANY, CHAS. EISLER, Pres.**  
751 So. 13th St. (near Avon Ave.) Newark, New Jersey



## NEW UNIVERSAL CUTTING HEAD

Full Frequency

U. S. Patent No. 2005154



Electrically, magnetically and mechanically balanced cutting head. Clear crisp recordings. Brilliant highs and full bass. No rubber or substitutes, nothing to deteriorate. Records freq. 30 to 30,000 cycles and over. Imp. 15 ohms. Requires plus 14 db. 2 to 3 watts. Climatically sealed. For replacement or new installations. Guaranteed uninterrupted service for life. Prof. discounts and liberal exchanges.

**Universal Microphone Co., Ltd.**  
424 Warren Lane Inglewood, Calif.

### ELECTRON TUBE PARTS

QUALITY All Types EST. 18 YEARS

Seal Finish Tungsten Welds  
Tungar Welds Coil Springs  
Filament Hooks Bases  
Spot Welders Caps  
Stem Wire Cutting & Forming Machines

**"The Engineering Co." of Newark, N. J., Inc.**  
Daniel Kondakjian, Pres.  
59 Branford Street Newark, N. J.

## ACTONE CUTTING STYLI

For recording direct on all coated aluminum or paper base discs. Individually lapped for a quiet, high quality cut.

**H. W. ACTON CO., Inc., 370 7th Ave., New York**

## VACUUM TUBES AND ELECTRONIC DEVICES

Design, Development and Construction of tubes and circuits.

**VACUTRON, INC.**  
2819 12 St. South Arlington, Va.

## FINE RIBBONS of Tungsten, Molybdenum and Special Alloys

To your specifications

**H. CROSS**  
15 BEEKMAN ST. NEW YORK

## HIGH "Q" NETWORK INDUCTANCES

Over 500 designs in use to-date  
**HOLLYWOOD TRANSFORMER CO.**  
7364 Melrose Ave. Hollywood, Calif.

**REX RHEOSTAT CO.**  
NEW YORK, N. Y.  
37 W. 20th ST.

### TECHNICAL DRAWINGS

FROM \$1.50. Expert illustrations, diagrams. Specialists photo-retouching, air-brush. Low prices. Mail orders filled promptly. 100% satisfaction guaranteed.

**Industrial Art & Drafting Co.**  
Phone Chelsea 2-7748 1123 Broadway, NYC.

New "CONTACTS" Advertisements must be received by April 26th to appear in the May issue.

Address copy to the  
Departmental Advertising Staff  
Electronics  
330 West 42d St., New York City

a-c and d-c voltage and current measuring ranges. In addition it will read db from minus 10 to plus 69.

## Frequency Modulation Components

THE BROWNING Laboratories, Winchester, Mass., announced component parts for receiving wide-band frequency modulation stations. Special broad-band 3 Mc i-f and detection transformers are available as well as a special high frequency tuner. A completely wired and aligned adapter is in production which may be plugged into the phonograph jack of any receiver. Bulletin 105A lists the components and includes a circuit wiring diagram of a complete receiver.

## Automatic Reset Timer

R. W. CRAMER Co., Inc., Centerbrook, Conn., announce RS automatic reset timer which is a very compact industrial instrument for automatic, accurate timing of a variety of electrical circuits. The timer consists essentially of an enclosed snap action switch unit actuated by an operating arm driven in one direction by a small synchronous motor with an enclosed



magnetically operated gear clutch and a spring resetting means to the starting position after the time cycle has been completed. The time settings are easily adjusted by setting the pointer to the desired time scale. Several time ranges are available to meet various timing requirements. The contact has a capacity of 10 amps at 115 volts or 5 amps at 230 volts. The instrument can be furnished for flush panel mounting or in a dustproof die cast case suited for BX or conduit wiring.

## High Vacuum Gauge

THE F. J. STOKES Machine Co., Philadelphia, Pa., has available a new model portable high vacuum gauge with a range from 0 to 700 microns and calibrated down to 1/10 micron. This gauge is designed to enable any unskilled operator to take readings quickly and accurately and is built to withstand hard service and constant handling without danger of breakage or damage.

AT YOUR FINGERTIPS



Complete  
MARKET AND MEDIA DATA  
ON ELECTRONICS

All market and media information on **ELECTRONICS** and its complete coverage of the electronic industry is now available to manufacturers and agencies in one easy-to-find File Folder.

Your file may be had by writing to **ELECTRONICS**. From time to time supplementary sheets will be sent to you to keep your files up to date on **ELECTRONICS** and its increasing importance to you as a powerful advertising medium for your products.

At your fingertips you will have the following classified information on **ELECTRONICS**:

1. **MARKET** — the electronics industry with latest figures on: quantity of products purchased in average year; type of products that can be merchandised successfully to this field through **ELECTRONICS**.
2. **CIRCULATION** — ABC statement; percentages showing **ELECTRONICS** penetration in each major circulation classification; example of coverage, graphic presentation of **ELECTRONICS** circulation growth in 10 years; foreign circulation; list of Market Analysis and Readership Surveys available.

3. **History and Scope of ELECTRONICS**. Short biographical sketch of executive editors and their editorial fitness.
4. **ADVERTISING** — advertising rates; list of advertisers using **ELECTRONICS** during 1939.
5. **SPECIFICATIONS** — Issue closing dates; mechanical requirements; information on halftones, stock, inserts, standard colors.
6. **MISCELLANEOUS** — Publication office, subscription rates, editorial and business staffs, district representatives. Special Services: direct mail division; market research department, copy service department.

Write today for this time saving file of data on your most valuable advertising medium.

**electronics**

330 West 42nd St.

New York, N. Y.

# EBY

## TIP JACKS



**STANDARD**  
All Molded



**STANDARD**  
Brass Barrel  
Molded Top



**HEAVY DUTY**  
All Molded  
7000 volt Breakdown

Can be furnished in colors  
—Red, Green & Black. Send  
for samples.



**HUGH H. EBY, Inc.**

4700 Stenton Avenue  
PHILADELPHIA, PA.



## FERRIS MODEL 18-B MICROVOLTER\*

- Combination of coils to cover the range of 4 to 150 megacycles
- Output 14 ohms continuously variable from a fraction of a microvolt to 100,000 microvolts over the full frequency range
- Ferris transmission line output system and resistance attenuator
- Write for bulletin E-18B for complete details
- Circulars on Signal Generators and Noise Meters are available on request

\*Reg. U.S. Pat. Off.

**FERRIS INSTRUMENT CORPORATION**  
BOONTON, NEW JERSEY

## Patents

**Generators.** A constant frequency, constant amplitude oscillation generation system. J. N. Whitaker, RCA. No. 2,162,520.

**Deflecting Coil.** Design of a magnetic circuit for deflecting electrons in a cathode ray tube. W. A. Tolson and I. G. Maloff, RCA. No. 2,155,514.

**Frequency Changer.** Klaas Posthumus, Eindhoven, RCA. No. 2,190,731.

**High Efficiency Resonant Circuit.** A high efficiency vacuum tube oscillator for high frequency. W. W. Hansen, Stanford University, Calif., assignor to The Board of Trustees of the Leland Stanford Junior University. No. 2,190,712.

**Circuit.** Feedback applied to electric discharge circuit. M. A. Edwards, G. E.Co. No. 2,190,775.

**Electron Discharge Device.** N. M. Rust, and G. F. Brett, London, RCA. No. 2,190,735.

**Converter Tube.** A converter tube having several grids coated with emitting material and a separate triode oscillator. W. H. Aldous, Wembley, England, No. 2,191,903.

**Tubes.** A tube in which the second and third grid are of the same pitch and are in alignment, with the second grid connected directly to the cathode. B. O. M. Gall and Jan Bart Hugenholtz, Eindhoven, RCA. No. 2,191,884.

**Metal Tube.** A metal tube construction making use of a glass stem. C. A. Horn, Roselle Park, N. J. Arcturus Development Co., Newark. No. 2,190,788.

**Gas Discharge Tube.** H. Kniepkamp. Siemens and Halske, Berlin, Germany. No. 2,192,162.

**Television.** Method of synchronizing. A. V. Bedford, RCA. No. 2,192,121.

**Television.** Method of synchronizing. M. Bowman-Manifold, E. C. Cork, and C. O. Browne, E.M.I. Inc., England. No. 2,192,122.

**Facsimile System.** J. D. Durkee, Bartlesville, Okla. No. 2,191,057.

**Television Tube.** Kurt Schlesinger, Berlin, Loewe Radio, Inc. No. 2,191,415.

**Measurements.** Apparatus and method for making field strength measurements, at ultra high frequencies. R. W. George, RCA. No. 2,191,277.

**Noise Suppression.** Apparatus for telephone lines. B. L. Fisher, Martinsville, Va. No. 2,191,375.

**Wave Transmission System.** Horace Whittle, Bell Laboratories. No. 2,191,065.

**Sound Indicating Apparatus.** Willard P. Place and Frederick C. Smith, Wilkesburg, Pa. No. 2,191,203.

## THE SOURCE of SATISFACTION for Relays

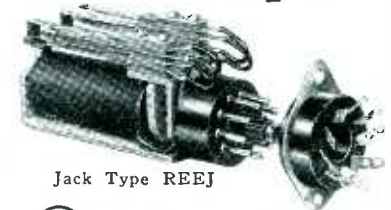

Jack Type REEJ

ONE of several Jack-Type relays in the complete Autocall line.

The REEJ has a single low current coil, pivoted armature, contacts positioned and maintained by current, contacts return to normal by contact spring tension.

For more than 30 years Autocall has specialized exclusively in signalling and control devices and equipment.

Write for Catalog!

**The Autocall Co.**  
SHELBY · · · OHIO

- RELAYS
- INDICATING DEVICES
- BELLS, HORNS, CHIMES
- MISC. EQUIPMENT
- TERMINAL DISCONNECT BLOCKS
- ANNUNCIATORS
- LIQUID FLOW DEVICES
- CODING TRANSMITTERS
- SIGNALLING SYSTEMS
- ALL TYPES

## PROFESSIONAL SERVICES

(Rates on Application)

### ELECTRICAL TESTING LABORATORIES

Characteristics of Vacuum Tubes  
Tests of photo cells, glow lamps, crater lamps.  
Tests of electronic and optical devices  
East End Avenue and 79th Street  
New York, N. Y.  
Phone: Butterfield 8-2600

### INTERNATIONAL ELECTRONICS, INC.

**DESIGN AND DEVELOPMENT**  
Radio ..... Television  
Sound ..... Electronics

**MANUFACTURING METHODS**  
Condensers ..... Tubes ..... Resistors  
Vibrators ..... Lamps ..... Speakers

630 Fifth Avenue New York, N. Y.  
Cable: Interengin, New York

### HAROLD J. McCREARY

Mem. A.I.E.E. & W.S.E.  
**Consulting Engineer**  
Laboratory Facilities

Research ..... Electronics  
Development ..... Television  
Design ..... Radio  
Factory Practice ..... Railroad Signaling  
Patent Studies ..... Telephony

105 W. Adams St. Phone STate 4003 Chicago, Ill.

### F. H. SHEPARD, JR.

**CONSULTING ENGINEER**  
**ELECTRONIC APPLICATIONS**  
Specializing In:

Industrial Control ..... Special Amplifier Design  
Follow-Up Devices ..... Photoelectric Applications  
Radio and Carrier Operated Remote Control

6167 Cedar Ave., Merchantville, N. J.  
Telephone Merchantville 1111

# POWER TRANSFORMERS

## AIR-COOLED TRANSFORMERS

for Voltage reduction. Insulated and Auto Types, from 1/4 K.-V. A. to 25 K.-V. A.

## SIGNALLING TRANSFORMERS

for reduction of line voltage to 4, 8, 12, 16, 20 or 24 volts 50 to 750 V. A.

## MERCURY VAPOR LAMP TRANSFORMERS

for maintaining the exact voltage necessary for highest Mercury Vapor Lamp efficiency.

## ACME also manufactures

Radio transformers in production quantities. Luminous Tube transformers. Acme Voltrol for 0 to 135 volt voltage regulation. Acme Break-down Tester. Your inquiries solicited.

THE ACME ELECTRIC & MFG. CO.  
31 Water Street Cuba, N. Y.

**Acme Electric**  
TRANSFORMERS



**AUDIODISC**

"masters" now enable every recordist easily to have his recordings reproduced as fine commercial pressings and transcriptions. They are making and breaking sales records with leading phonograph record producers and platers who enthusiastically recommend them for perfect processing.

- The exclusive, micrometrically uniform, machine-made coating of AUDIODISC "masters" produce the flattest, shiniest, pressings.
- The chemical properties of AUDIODISC permit finer grained silvering and electroplating.
- Better HIGH response makes the sound qualities of AUDIODISC "masters" superior for all commercial and professional purposes.
- AUDIODISC "masters" will solve your processing problems. Write for further information.

**AUDIO DEVICES, Inc.**  
1600 BROADWAY,  
NEW YORK CITY  
Cable: Audivices New York

**Measurements.** A means for making impedance measurements at high radio frequencies. P. S. Carter, RCA. No. 2,191,271.

**Diode Oscillator.** A negative resistance device making use of a resonant cavity and the electron transit time between elements of the tube. F. B. Llewellyn, Bell Laboratories. No. 2,190,668.

**Electric Discharge Circuit.** A means to control de-energization of the control electrode of a discharge tube. E. F. W. Alexanderson, G.E.Co. No. 2,190,759.

**Hearing Aid.** William D. Penn, Dallas, Texas. No. 2,191,398.

**Record Changer.** Paul U. Lannerd, General Industries Co. No. 2,191,214.

**Automatic Phonograph.** Paul U. Lannerd, General Industries Co. No. 2,191,215.

**Interference Rejection Receiver.** Potentials of opposite phases but otherwise substantially identical to noise potentials are introduced into the circuit, thereby effectively cancelling noise. D. V. Sinninger, Johnson Laboratories. No. 2,190,850.

**Tube Tester.** For measuring the dynamic co-efficients of a thermionic tube. Floyd E. Wenger, Ray L. Triplett, Bluffton. No. 2,190,962.

**Electric Control System.** For controlling synchronous motors. Elmo E. Moyer, G.E.Co. No. 2,190,756.

## COSMIC RAY PHOTOS MADE AT RECORD ALTITUDE



Two associates of A. H. Compton, at the University of Chicago, made a series of 400 cosmic ray photographs from an altitude of 29,300 feet. Above 15,000 feet the five men who occupied the Douglas transport plane housing the recording equipment, were required to use oxygen tanks. The men were in the air for four hours over northern Illinois in this test. Left to right: Wilfred Davis, Dr. Gerhard Herzog, Winston Bostwick (kneeling), Capt. W. E. Larned, and First Officer R. J. Nemmers.

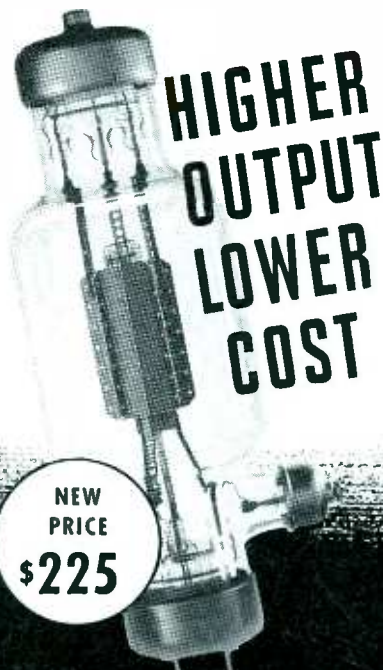

NEW  
PRICE  
**\$225**

With the improved type  
**1554 GAMMATRON**  
plate dissipation—1000 watts

WRITE FOR DATA

**HEINTZ AND KAUFMAN**  
SOUTH SAN FRANCISCO LTD. CALIFORNIA U.S.A.

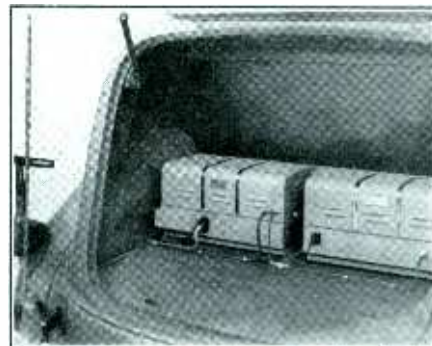

Complete UHF Mobile Installation

## TWO-WAY POLICE RADIOTELEPHONE

- ★ 8 AND 20 WATT TRANSMITTERS
- ★ CRYSTAL CONTROLLED RECEIVER WITH SQUELCH CIRCUIT AND NOISE SILENCER
- ★ RUGGED AND ECONOMICAL DESIGN
- ★ OUTSTANDING PERFORMANCE

Write for complete technical specifications

**KAAR ENGINEERING CO.**  
PALO ALTO, CALIFORNIA

Manufacturers of High-Grade Marine and Police Radiotelephone Equipment

**"The Standard  
by Which Others  
Are Judged  
and Valued"**



**O**NLY the highest development in pickups . . . and that means MICRODYNE . . . can possibly return the highest grade of performance,—CONSISTENTLY. Scientists are absolutely agreed that the MAGNETO-INDUCTIVE principle is the ONLY principle capable of this. Observe how:—

in Radio Stations, Studios,—in fact, wherever high-grade reproduction is desired—the MUST specification is

**MICRODYNE!**

Flat to 9000 cycles, and beyond—low needle impedance—absence of distortion—low point pressure—complete indifference to climatic changes—sharp, clean-cut definition you cannot approach except with the MICRODYNE type of pickup. Yet, for all its superior qualities,—COSTS NO MORE THAN THE ORDINARY PICKUP.

*Don't be satisfied — YOURSELF — with anything less than MICRODYNE!*

List prices from  
**\$12.50 to \$140.00**

We will shortly tell you about still another AUDAX development in CUTTERS . . . and WHAT A CUTTER!

Write for Latest Literature

**AUDAK COMPANY**  
500 Fifth Avenue New York City  
"Creators of High Grade Electrical and Acoustical Apparatus Since 1915"

**INDEX TO ADVERTISERS**

Acheson Colloids Corp.	115	Kaar Engineering Co.	121
Acme Electric & Mfg. Co.	121	Kenyon Transformer Co.	11
Acton Co., Inc., H. W.	118	Kirkland Co., H. R.	118
Aerovox Corp.	70	Kurman Electric Co.	102
Alden Products Co.	104	Lampkin Laboratories	110
American Automatic Electric Sales Co.	90	Lamson & Sessions Co.	7
American Lava Corp.	61	Lansing Mfg. Co.	90
American Microphone Co.	100	Lapp Insulator Co.	9
American Screw Co.	7	Lenz Electric Mfg. Co.	77
American Transformer Co.	59	Lingo & Son, Inc., John E.	92
Amperex Electronic Products, Inc.	1		
	Inside Front Cover, 1		
Astatic Microphone Laboratory, Inc.	95	Mallory & Co., Inc. P. R.	12
Audak Company	122	McGraw-Hill Book Co., Inc.	116
Audio Devices, Inc.	121	Millen Mfg. Co., Inc. James	113
Autocall Co.	120		
		National Screw & Mfg. Co.	7
		National Vulcanized Fibre Co.	75
Bakelite Corp.	Inside Back Cover		
Ballantine Laboratories, Inc.	96	Ohmite Mfg. Co.	73
Barker & Williamson	122	Oxford-Tartak Radio Corp.	101
Belden Mfg. Co.	65		
Benwood-Linze Co.	118	Parker-Kalon Corp.	7
Biddle Co., James G.	95	Pheoll Mfg. Co.	7
Blaw-Knox Co.	84	Phillips Screws	7
Bliley Electric Co.	93	Pioneer Gen-E-Motor Corp.	95
Bud Radio, Inc.	94	Precision Apparatus Co.	117
		Precision Resistor Co.	111
Callite Products Division	97	Precision Tube Co.	113
Cannon Electric Development Co.	57	Presto Recording Corp.	78
Capitol Radio Engineering Institute	107		
Carborundum Co.	108	Radio Wire Television, Inc.	111
Carter Motor Co.	110	RCA Mfg. Co.	Back Cover
Centralab Div., Globe-Union, Inc.	5	Raytheon Mfg. Co.	97
Cinch Manufacturing Co.	55	Remler Co., Ltd.	92
Clare & Co., C. P.	110	Rex Rheostat Co.	118
Clarostat Mfg. Co.	167	Richardson Co.	56
Cohn, Sigmund	100	Roller-Smith Co.	6
Continental Screw Co.	7	Russell, Burdsall & Ward Bolt & Nut Co.	7
Corbin Screw Corp.	7		
Cornell-Dubilier Electric Corp.	52	Sangamo Electric Co.	117
Cross, H.	118	Scovill Mfg. Co.	7
		Shakeproof Lock Washer Co.	7
Daven Co.	106	Shallcross Mfg. Co.	116
Doolittle & Falknor, Inc.	93	Sola Electric Co.	117
Driver Co., Wilbur B.	113	Speer Carbon Co.	76
Du Mont Laboratories, Inc., Allen B.	114	Stackpole Carbon Co.	10
Du Pont Plastics	85	Superior Tube Co.	4
Dunn, Inc., Struthers	105	Synthane Corp.	67, 68
Eby Inc., Hugh H.	120	Televiso Co.	104
Eisler Engineering Co.	118	Thomas & Skinner Steel Pds. Co.	108
Eitel-McCullough, Inc.	74	Triplett Electrical Instrument Co.	115
Electrical Research Products, Inc.	101	Tubular Rivet & Stud Co.	58
Electrical Testing Laboratories	112		
Engineering Co. of Newark, N. J., The	118	Universal Microphone Co., Ltd.	96
Eric Resistor Corp.	2	Vacutron, Inc.	118
Ferranti Electric, Inc.	80	Ward Leonard Electric Co.	64
Ferris Instrument Corp.	120	Western Electric Co.	87
Formica Insulation Co.	71	Westinghouse Electric & Mfg. Co.	62, 63
		Weston Electrical Instrument Corp.	79
Gardiner Metal Co.	107	Whisk Laboratories	104
General Ceramics Co.	88, 89	White Dental Mfg. Co., S. S.	60, 94
General Electric Co.	81, 86	Wiley & Sons Inc., John	111
General Radio Co.	8	Wilson Co., H. A.	105
Goat Radio Tube Parts, Inc.	103		
Guardian Electric Mfg. Co.	66	Zophar Mills, Inc.	108
Hallierafters Inc.	103		
Heinemann Circuit Breaker Co.	96		
Heintz & Kaufman Ltd.	121		
Hewlett-Packard Co.	100		
Hollywood Transformer Co.	118		
Hunter Pressed Steel Co.	72		
Industrial Art & Drafting Co.	118		
Industrial Resistors, Inc.	92		
International Nickel Co.	69		
International Resistance Co.	49		
Isolantite Inc.	83		
Johnson Co., E. F.	98		
Jones, Howard B.	103		

**SEARCHLIGHT SECTION**  
(Classified Advertising)

**EMPLOYMENT** 106  
**EQUIPMENT FOR SALE**

Eisler Electric Corp. 106  
Kahle Engineering Corp. 106

# STANDARD or SPECIAL . . .

**Ask B&W First!**

These specially-designed B&W Coils, used in conjunction with Cardwell Condensers, were adopted as standard in the 50 two-way transmitters engineered by Lieut. A. A. Kirchner, in consultation with Rissi Bros., Inc., for the Grand Rapids Police Department.

No matter what YOUR requirements—aircraft, marine, police, commercial, diathermy, general communications or amateur—chances are you can select the coil you need from the 125 standard B&W types. If not, we will gladly cooperate in designing the proper coil for your special requirements.

## B & W AIR INDUCTORS

**BARKER & WILLIAMSON · ARDMORE, PA.**





# electronics

## CONTENTS—SEPTEMBER, 1940

### KEITH HENNEY

Editor

Donald G. Fink  
Managing Editor

Beverly Dudley                      Craig Walsh  
Associate Editor                      Assistant Editor

M. L. Matthey                      J. M. Heron  
Assistant Editor                      Assistant Editor

Harry Phillips  
Art Director

### H. M. MATEER

Manager

Wallace B. Blood  
Sales Manager

Contents Copyright, 1940, by  
McGraw-Hill Publishing Company, Inc.

McGRAW-HILL  
PUBLISHING COMPANY, INC.

JAMES H. McGRAW  
Founder and Honorary Chairman

Publication Office  
99-129 North Broadway, Albany, N. Y.  
U. S. A.

Editorial and Executive Offices  
330 West 42nd St., New York, N. Y., U. S. A.

James H. McGraw, Jr., President  
Howard Ehrlich, Executive Vice President  
Mason Britton, Vice Chairman

B. R. Putnam, Treasurer  
D. C. McGraw, Secretary  
J. E. Blackburn, Jr., Director of Circulation

Cable Address:  
MCGRAWHILL, New York  
Member A. B. P. Member A. B. C.

### ION PATHWAY ..... Cover

High speed atomic particles, issuing from the exit window of the cyclotron at Harvard University, bombard air particles at energies of several million volts, causing a visible glow. Photograph by Paul H. Donaldson, Cruft Laboratory, Harvard University

### ELECTROMAGNIFIER ..... Frontispiece

The electron microscope developed at R.C.A. Laboratories in Camden

### FM—105 HOURS PER WEEK ..... 17

The new transmitter at W2XOR, employing a unique method of synchronizing, operates on the most extensive schedule of any f-m station at present

### WEAF—PORT WASHINGTON ..... 20

The story of the search for WEAF's new site, the acquisition of the land and the engineering features of the station erected on it

### NEW STUDIOS FOR C.B.S. .... 23

A recent addition to Columbia's New York studio set-up in the former Juilliard School Building, makes use of movable vanes for controlled acoustics, and extends former specifications on audio response, noise and distortion

### TESTING CERAMIC CAPACITORS, by E. T. Sherwood ..... 26

Description of an unusually complete and accurate set-up for measuring the temperature characteristics of ceramic units

### MODULATION LIMITS IN FM, by L. J. Black and H. J. Scott ..... 30

Computation of deviation limits permissible for given f-m channel widths and given maximum audio frequencies

### "TUNE 550—HIGHWAY RADIO AHEAD" ..... 32

A strictly local transmitter on the George Washington Bridge, New York, informs motorists from a magnetic tape reproducer

### RECENT IMPROVEMENTS IN RECORDING, by C. J. LeBel ..... 33

Mechanical and electrical features of recording equipment put on the market during the past eighteen months

### PERFORMANCE OF A SELF-EXCITED INVERTER, by F. N. Tompkins ..... 36

Results of a critical study of frequency and waveform characteristics of a thyatron dc-to-ac inverter

### SIMPLE PULSE-GENERATING CIRCUITS, by S. P. Sashoff and W. K. Roberts ..... 40

Methods of producing sharp voltage pulses at power line frequency by differentiation of a square wave and by selecting portions of a rectified wave

### FREQUENCY ASSIGNMENTS IN THE RADIO SPECTRUM Supplement (Part II of this issue)

A chart showing the class of service on all frequencies from 10 kc to above 400 Mc compiled from the latest F.C.C. lists

### DEPARTMENTS

CROSSTALK .....	15	THE ELECTRON ART .....	72
NEW BOOKS .....	42, 90	THE INDUSTRY IN REVIEW .....	82
TUBES AT WORK .....	44	PATENTS .....	91
TUBES .....	66	INDEX TO ADVERTISERS .....	92

ELECTRONICS, September, 1940, Vol. 13, No. 9. Published monthly, price 50c a copy. Allow at least ten days for change of address. All communications about subscriptions should be addressed to the Director of Circulation, 330 West 42nd Street, New York, N. Y.

Subscription rates—United States and possessions, Canada, Mexico and Central American countries, \$5.00 a year, \$8.00 for two years, \$10.00 for three years. Great Britain and British Possessions 36 shillings for one year, 72 shillings for three years. All other countries \$6.00 for one year, \$12.00 for three years. Entered as Second Class matter, August 29, 1936, at Post Office, Albany, New York, under the Act of March 3, 1879. BRANCH OFFICES: 520 North Michigan Avenue, Chicago; 68 Post Street, San Francisco; Aldwych House, Aldwych, London, W.C. 2; Washington; Philadelphia; Cleveland; Detroit; St. Louis; Boston; Atlanta, Ga.

for Every Application

Series II

# Centralab SOUND PROJECTION CONTROLS

## CENTRALAB SERIES II

Controls are the finest for input circuits in broadcast stations, public address systems, and recording apparatus of new or old design. Will prove faultless in the most critical service.

The curve chart above shows the change in impedance and attenuation plotted against clockwise rotation for a "T" pad attenuator. The impedance characteristic (dotted line) is substantially the same at any setting. The attenuation curve (solid line) varies from infinity at zero rotation to zero Db. at full rotation. No insertion loss.

Electrostatic and electromagnetic shielding provided by a black finished steel case. Bakelite screw type terminal strip on back of case. All resistance elements insulated from shaft and bushing. Single hole mounting. Mounting bushing  $\frac{3}{4}$ " long with 2 locknuts and lockwashers. Case diameter  $2\frac{3}{4}$ ". Depth back of panel "T" Pad —  $2\frac{3}{8}$ "; Gain Control —  $1\frac{3}{8}$ ". Maximum load dissipation 1 watt.

For detailed information, write for technical booklet.

**CENTRALAB: Division of Globe-Union Inc.**  
MILWAUKEE, WISCONSIN

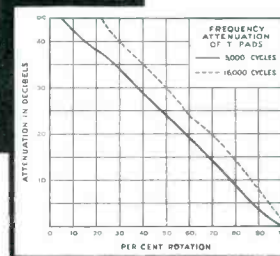
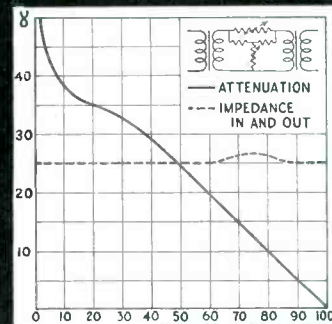

## ECONOMY P/A CONTROLS

These controls are intermediate to the series II line and the older series I types. As their name implies, they are economy controls designed primarily for inexpensive sound equipment, where original cost is a limiting factor. They are designed for all types of fading and mixing systems. All units have soft aluminum shaft  $2\frac{1}{4}$ " from end of  $\frac{3}{8}$ " brass bushing. Small diameter bakelite case same dimension as Standard Radiohm. Non-rubbing contact for smooth, quiet operation. Limited to input applications. Maximum power rating for all units one watt.

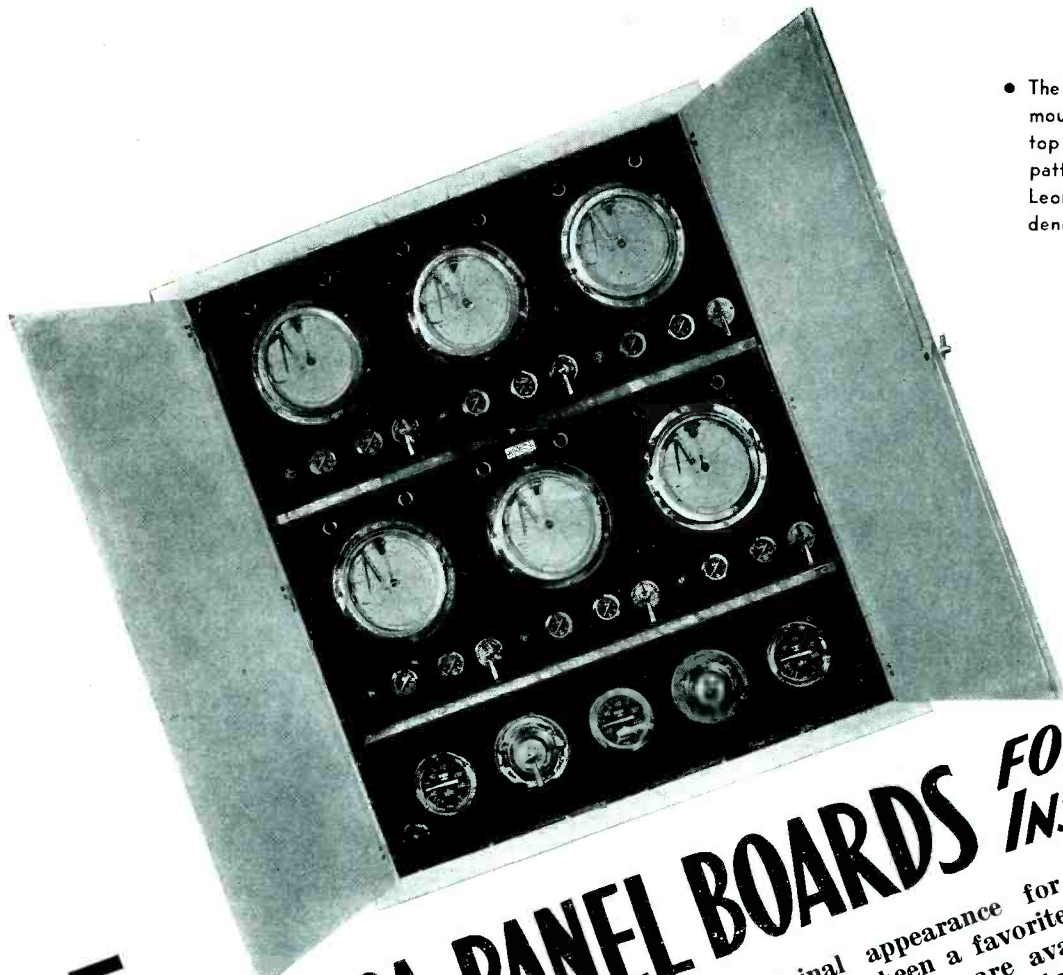

• The pictures show panel boards for mounting instruments—black at the top and brown and white marble pattern at the bottom as used by the Leonard Valve Company of Providence, R. I.

# • FORMICA PANEL BOARDS FOR INSTRUMENTS

A PANEL board to be used for many years must have a good looking and at the same time very durable surface that will never need refinishing. Formica boards meet the requirement. They are among the most inert chemically of organic material and therefore do not react with the atmosphere. They do not check spot, corrode, rot or rust, but maintain

their original appearance for many years. Black has long been a favorite color for such purposes, but boards are available in brown and white marble, Verde Antique and Black and Gold patterns as well as wood grains and plain solid colors and indefinite patterns. If you would like to liven up your panels by adopting a new color ask us to send samples.

The Formica Insulation Co., 4661 Spring Grove Ave., Cincinnati, O.

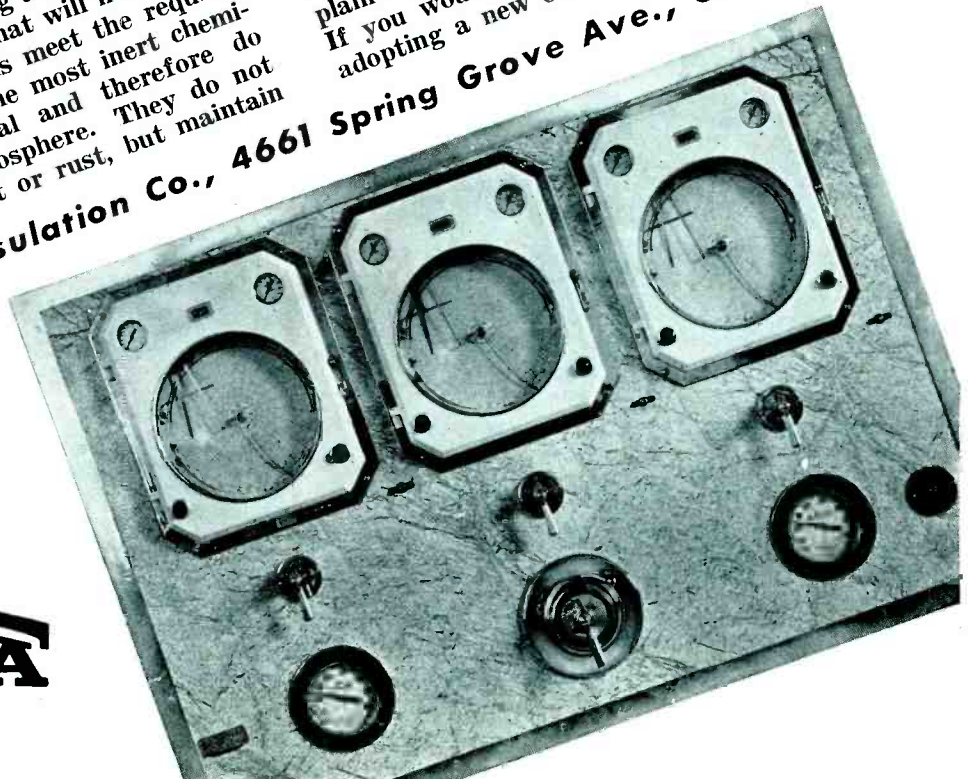

## FORMICA

**BELDEN WIRING DATA CHART HOOK-UP WIRES**

MINIMUMS

Wire No.	Surge Imp. Ohms	Power Freq. %	D.S. Loss	Att. Coef.	Max. Cap. p. Ft.
100	90	2.31	960	30000	200
82001	97	2.01	4180	22000	200
180	72.5	2.15	2000	20000	200
40000	71.0	1.13	4300	20000	200
100	84.1	1.75	220	10000	210
40000	85.7	2.02	525	10000	200
100	71.5	1.25	707	10000	180
40000	71.8	1.23	4300	10000	200



**BELDEN WIRING DATA CHART MICROPHONE CABLES**

MINIMUMS

Wire No.	Surge Imp. Ohms	Power Freq. %	D.S. Loss	Att. Coef.	Max. Cap. p. Ft.
8421	44				
8402	44				
8402	44				
8402	44				
8402	44				
8402	44				
8402	44				
8402	44				
8402	44				
8402	44				

# WIRES have case histories, too

These Wires are Approved  
—they're made by Belden

**TRANSMISSION LINE CABLES**

Wire No. Surge Imp. Ohms Power Freq. % D.S. Loss Att. Coef. Max. Cap. p. Ft.

**8219—100 Ohm Twisted Pair, for Television or FM**

**8210—E01 Type, for Small Transmitters and Amateur Use**

**8204—72 Ohm Twisted Pair, for Broadcast and Short Wave**

**8209—Shielded Twisted Pair**

**MICROPHONE CABLES**

o. d. Max. Cap. p. Ft.

**8421—Shielded, Rubber Sheathed, Single Conductor**

**8402—Two Conductor, Crystal Microphone (also 3 to 7 conductor cable)**  
8422—2-conductor for Carbon Microphones

**8433—Multiple conductor—Shielded only (also 2 or 4 conductors)**

**MULTIPLE CONDUCTOR CABLE**

**8453—Rubber Sheathed (2 to 5 conductors)**

**8445—Over-all Glazed Cotton (3 to 9 conductors)**  
For speakers, remote control equipment, multiple circuits, etc.

**P. A. AND COMMUNICATING SYSTEM CABLES**

o. d.

**8701—Twisted Pair Type, for Inside Use (1 to 19 pairs)**

**8799—Shielded Twisted Pair, for Inside Use**

**8773—Twisted Pair Type (One conductor shielded), Inside or Outside Use**

\*Values of surge impedance may vary ± 10% from nominal 72 or 100 ohm values  
†MMF per Ft. between Conductor and Shield

There's a healthy specimen  
for your requirements

Belden Wires are engineered from start to finish. They are designed and manufactured to meet the most exacting requirements of the radio industry. "Case histories"—complete performance records of the wires you need—can simplify your engineering problems.

Careful inspection maintains the vital characteristics in every foot of Belden wire—its consistent quality will likewise simplify manufacturing problems and assure uniform performance—fewer rejections.

Long years of collaboration with the radio industry make Belden Wire Service complete—you can buy with confidence—Belden Wires and Cables for every radio or sound equipment requirement. Use the right wire for every job—Specify Belden.

Belden Manufacturing Company  
4625 W. Van Buren St., Chicago, Ill.

*Don't Go "Haywire"*

Go **Belden**

**WIRES FOR RADIO AND COMMUNICATIONS**

271-A      272-A      292-C

*Wherever Lump Capacitance is needed...*

**LAPP GAS FILLED CONDENSERS WILL SAVE SPACE, SAVE POWER, SAVE MONEY**

In any transmitting system, there are numerous places where installation of Lapp gas-filled condensers will improve transmission efficiency with economy of space and security of operation.

Installations now in service include: plate tuning circuits—fixed condensers for coil tuning, variable condensers for condenser tuning; antenna coupling circuits; tuning circuits for directional antenna arrays; filter networks—tuned circuits to eliminate harmonics.

To every application the Lapp condenser brings notable mechanical and electrical advantages: practically zero loss, minimum space requirement, non-failing, puncture-proof design, constant capacitance under varying temperature conditions. Fixed, adjustable and variable types in three voltage ratings and capacitances, 100 to 2000 mmf—54 models in all, price \$75 to \$500. *Descriptive literature is available on request. Want to see it?*

**LAPP**

**INSULATOR CO., INC.**

**LEROY, N. Y., U. S. A.**

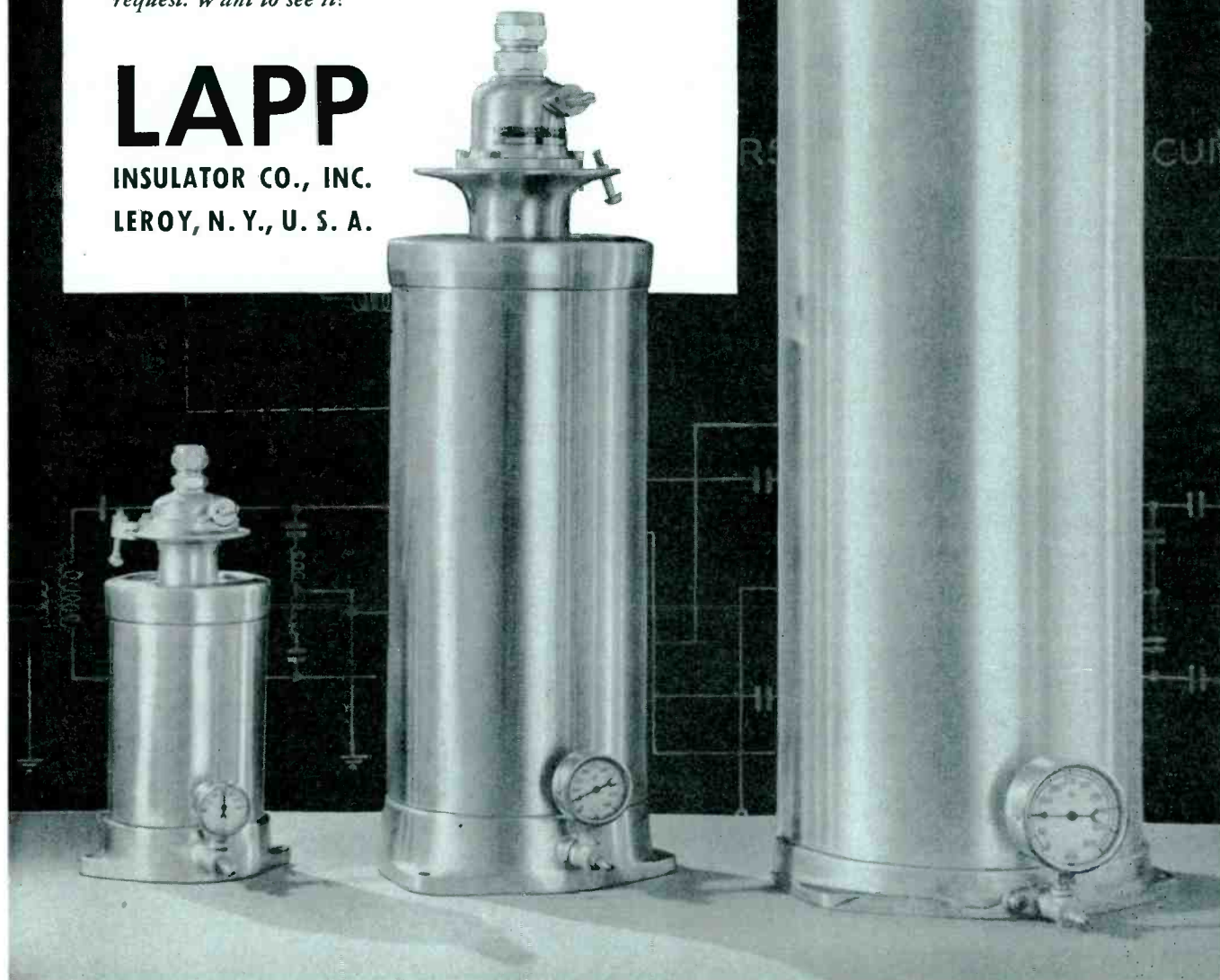

# Frequency Modulation

## EXTENDED RANGE—HIGH FIDELITY

THERE is now available a complete family of special Jensen products for Frequency Modulation and Television receivers—as well as for monitoring and studio work. Illustrated below is the beautiful new Walnut "CA" type Bass Reflex cabinet—available in two sizes. One houses the new 12-inch PM extended range speaker. The other utilizes the new dual-unit 15-inch PM speaker complete with filter network. Below is also illustrated the "M" type Bass Reflex reproducer finished in brown lacquer—available with either the 8", 12" or 15" dual-unit extended range speaker. They are all extremely modestly priced. The three speakers are, of course, obtainable without the enclosures. The 15-inch dual-unit in Permanent Magnet design complete with filter network is only \$46.50 LIST. The 8" and 12" speakers show an extended high frequency response up to 12,000 cycles. The 15-inch dual-unit model is extended to 14,000 cps. Jensen Radio Mfg. Co., 6601 S. Laramie, Chicago.

Jensen  
Bass Reflex  
REPRODUCERS



# LOGS JAM! WHEN THE STREAM IS LOADED

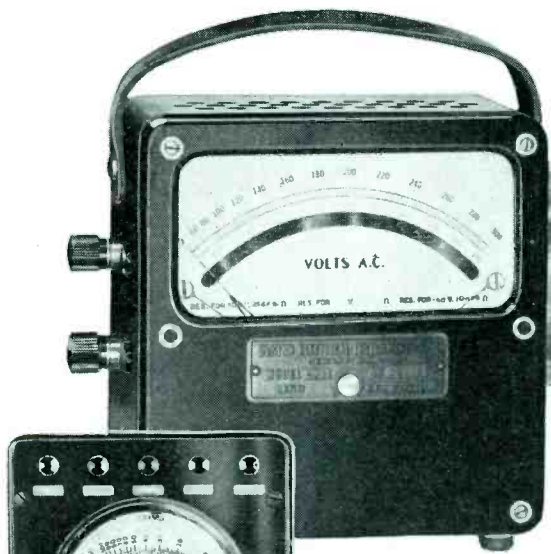
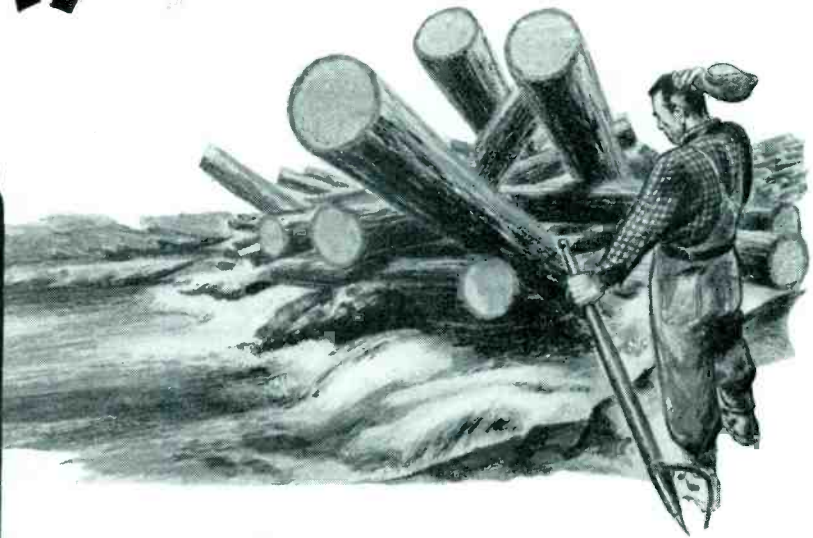

WESTON portable Instruments for quick, efficient maintenance testing.



WESTON portable multi-range instruments for production testing and inspection.

WESTON panel and switchboard Instruments . . . all types, sizes and ranges required.

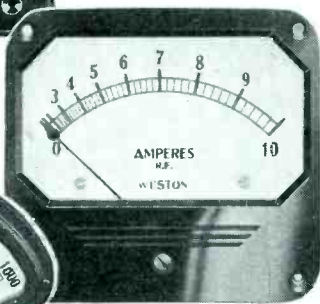

WESTON Electrical Tachometers — calibrated in R.P.M., feet-per-minute, or any desired units.



WESTON multi-range AC Clamp-Ammeter . . . for time saving current measurement...trouble shooting.

## WITH WORK FLOW "ON THE RISE" Industry forestalls production log-jams ...WITH WESTONS

Today, more than ever, the production stream must be kept flowing smoothly. Electrical circuits, motors and all electrified equipment must be maintained to operate steadily, efficiently . . . without costly break-downs and work interruptions. The production and assembly of electrical units must be of uniformly high quality . . . to check costly rejects and other waste along production lines. And in the generation and distribution of electrical power, adequate control is essential to assure maximum efficiency with minimum waste.

Throughout industry today, in plants where the need for uninterrupted work flow is vital, WESTON instruments are on the job; forestalling maintenance troubles . . . safeguarding production operations and processes . . . providing smooth, efficient operations throughout, at lower costs. WESTONS invariably are assigned these important tasks because today's exacting needs call for instruments of unquestioned accuracy and long-time reliability...qualities which WESTONS supply in fullest measure.

Why not check with your local WESTON representative today, to make sure there are no potential "jam-points" in your production stream which might be kept "clear" with adequate instrumentation. His counsel is freely offered. Weston Electrical Instrument Corp., 618 Frelinghuysen Avenue, Newark, N. J.

Laboratory Standards . . . Precision DC and AC Portables . . . Instrument Transformers . . . Sensitive Relays . . . DC, AC, and Thermo Switchboard and Panel Instruments.

# WESTON

Specialized Test Equipment . . . Light Measurement and Control Devices . . . Exposure Meters . . . Aircraft Instruments . . . Electric Tachometers . . . Dial Thermometers.

**FOR OVER 52 YEARS LEADERS IN ELECTRICAL MEASURING INSTRUMENTS**

# The WATCHDOG of your "push button" tuning system

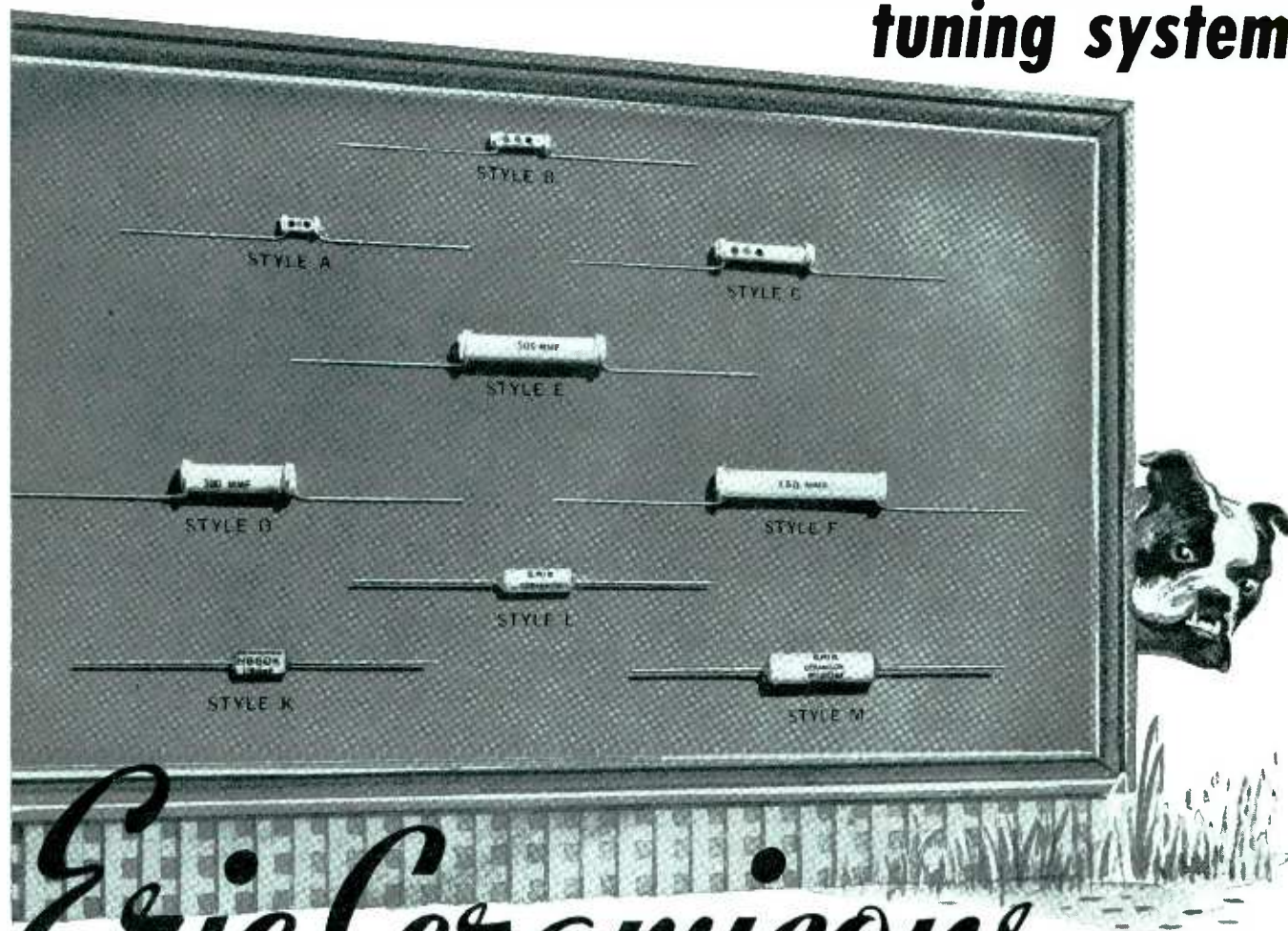

## Erie Ceramicons

REG. U. S. PAT. OFF.

## COMPENSATING CONDENSERS

Because a single unit Erie Ceramicon can be supplied to compensate for any desired frequency drift from  $+.00012$  mmf/mmf/°C. to  $-.00070$  mmf/mmf/°C., it will provide simple and efficient protection against frequency drift in your automatic tuning radio receivers.

The use of an Erie Ceramicon does not involve complicated engineering, or drastic changes in either the design or production set-up. Simply determine the total amount of frequency drift present and insert a Ceramicon with the same temperature coefficient, but of opposite sign, as part or all of the oscillator capacitive reactance. Since these ceramic-dielectric condensers have a definite, linear and reproducible temperature coefficient, the compensation will maintain its efficiency for the life of the receiver.

Erie Ceramicons are available in both insulated and non-insulated types as illustrated above. Our engineering department will be glad to recommend specific units to fit your requirements.

RESISTORS  
SUPPRESSORS  
CERAMICONS  
SILVER-MICA  
CONDENSERS

**Erie** RESISTOR CORPORATION, ERIE, PA.  
TORONTO, CANADA • LONDON, ENGLAND • PARIS, FRANCE-J.E.CANETTI CO.

MOLDED BEZELS  
PUSH BUTTONS  
AND KNOBS  
POLYSTYRENE  
COIL FORMS



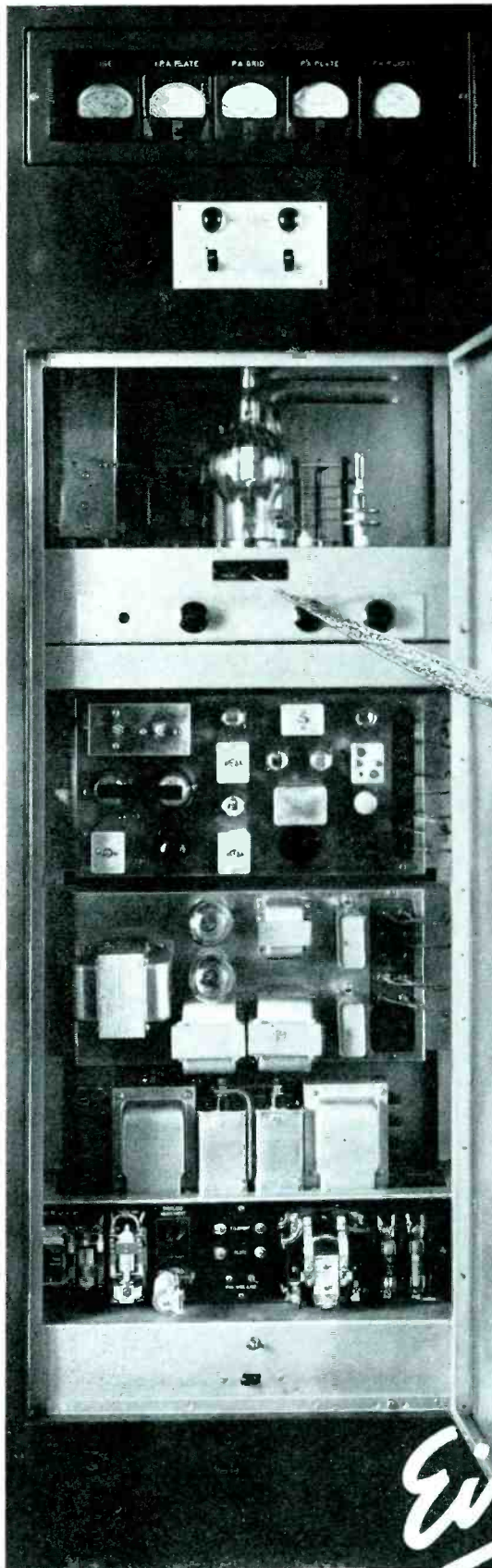

# FM and Eimac Join the Conn. State Police Force

The first statewide 2-way telephone system in the USA... using Dr. Edwin H. Armstrong's Frequency Modulation system

Daniel E. Noble, pioneer designer of FM stations is responsible for this decidedly practical use of FM communication. There are ten such stations being installed for the Connecticut State Police Department. First one placed in operation August 1, 1940 and the tenth will go into operation about September 15th. This represents just one more "first" for Eimac and an important "first" it is, too.

Mr. Noble says: "I selected the Eimac 250T tube because of its excellent ultra high frequency operating characteristics."

The idea of statewide radio telephone communications is a step in the right direction. The idea of using FM is certainly a wise one, but the idea of using Eimac Tubes for all these transmitters is a logical one. Eimac Tubes not only provide the utmost in dependability but are the tried and proven tube for use in FM.

*Engineers interested in FM should consider well Eimac's background, take no chances on untried tubes. Write for further details or see your nearest representative.*

**Eimac  
TUBES**

One of ten FM stations for the Connecticut State Police Department designed by Daniel E. Noble and constructed by Fred M. Link. This system will permit two way conversation between officers and fixed stations throughout the state. Contact with headquarters is never broken. A close approach to the ideal in police radio service.

Colo., Wyo., New Mexico,  
Arizona, Utah  
**RICHARD A. HYDE,**  
4253 Quitman St., Denver,  
Colo.

California, Nevada  
**HERB BECKER,** 1530 W.  
104th St., Los Angeles, Cal.

N. Caro., S. Caro., Georgia,  
Tenn., Flor., Ala., Miss.  
**JAMES MILLAR,** 316  
Ninth St. N. E., Atlanta,  
Georgia

N. Y., N. J., Penn., Md., Del.,  
Dist. of Col., Maine, N. H.,  
R. I., Conn., Mass.

**ADOLPH SCHWARTZ,**  
14726 Elm Ave., Flushing,  
New York

Wash., Ore., Idaho, Mont.  
**GENERAL SALES CO.,**  
Verner O. Jensen, 2605-07  
Second Ave., Seattle, Wash.

Texas, La., Okla., Ark.  
**J. EARL SMITH,** 2821  
Live Oak St., Dallas, Texas

Chicago, Illinois, Wisconsin  
**G. G. RYAN,** 549 W.  
Washington Blvd., Chicago,  
Ill.

Ohio, Mich., Ky., Ind., Minn.,  
Mo., Kan., Neb., Iowa  
**PEEL SALES ENGINEERING CO.,** E. R. Peel  
154 E. Erie St., Chicago, Ill.

# The INSULATED RESISTOR *Marches On!*

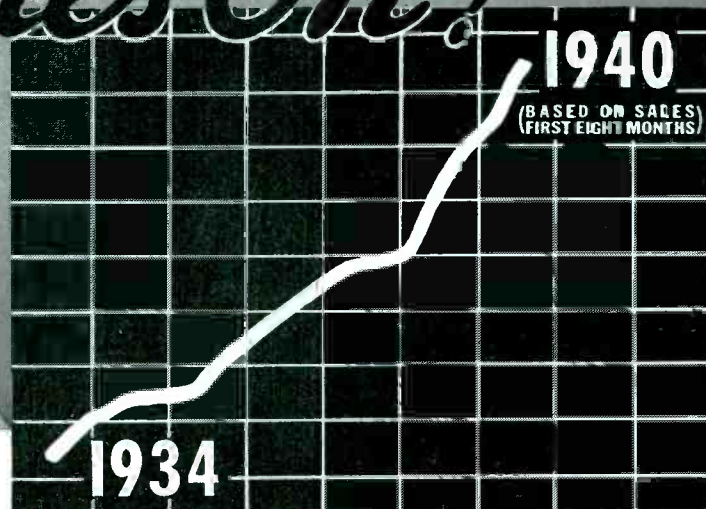

**T**his chart depicts the sales growth of Type BT and Type BW Insulated Resistors since 1934 when IRC pioneered and introduced bakelite insulation construction in the resistance field. Based on the sale of many millions of units the first year, it shows plainer than words the rapidity of the trend toward the use of insulated resistors. Based to a major extent on sales to the largest, most exacting buyers in the radio and electrical industries, it proves beyond question the ability of this modern and exclusively IRC resistance development to combine economy with dependability.

INTERNATIONAL RESISTANCE COMPANY  
403 North Broad St. Philadelphia, Pa.



## INSULATED RESISTORS

Type BT ("Metallized" Element)

Type BW (Wire Wound)

★

# HARDLY A HANDFUL

But Its OUTPUT  
Is 1800 Watts  
up to 150 MC!

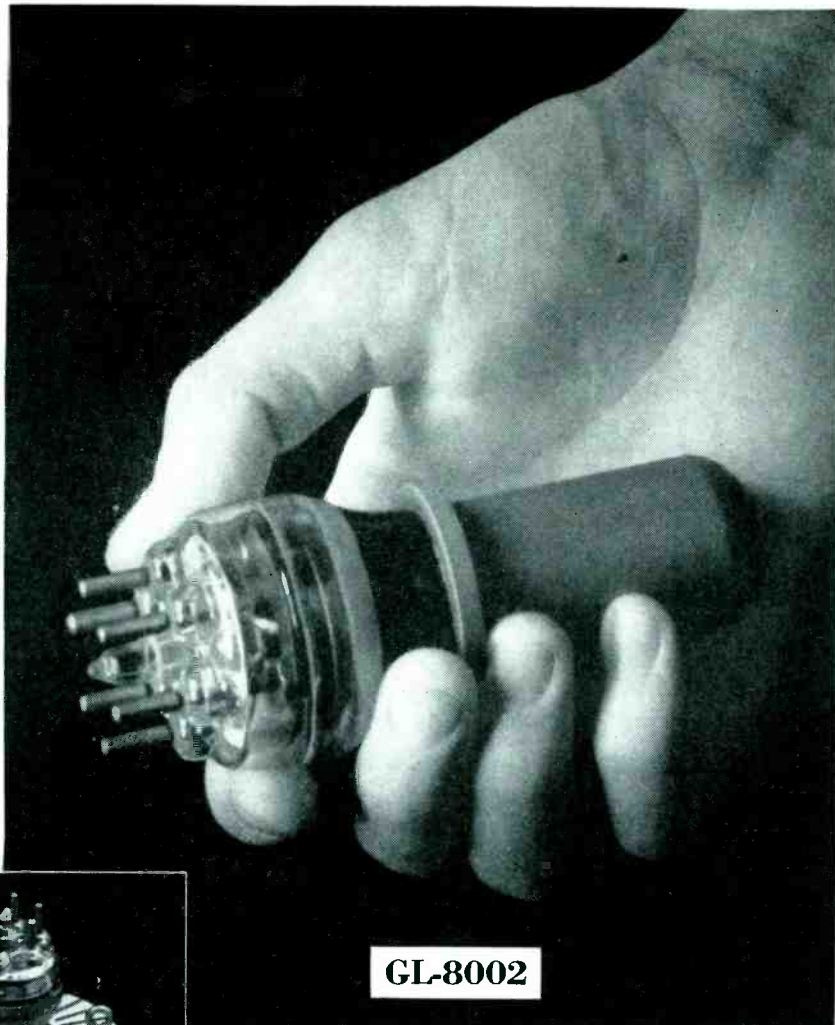

GL-8002

★

And the air-cooled  
GL-8002-R  
puts out 1800 watts  
up to 120 MC.



GL-8002-R's radiator is milled from solid copper. Air passages are of uniform width for more efficient cooling. Total height, including radiator, is 5 3-8 inches; total diameter, 3 11-16 inches.

Characteristics—GL-8002 and GL-8002-R

Fil Volts . . . . . 16	Mutual Conductance . . . . .
Fil Current . . . . . 39 amp	8850 mmhos
Direct Interelectrode Capacitances, Approx.:	Class C Telegraph Rating
Grid to plate . . . . . 9 mmf	Plate Volts . . . . . 3000
Grid to filament . . . . . 8 mmf	Plate Input, Watts . . . . . 3000
Plate to filament . . . . . 0.5 mmf	Plate Dissipation, Watts 1200
GL-8002—\$180	GL-8002-R—\$250

**B**UILT to speed the conquest of the ultra-highs, General Electric's latest are marvels of vacuum-tube design.

These tiny triodes lick many basic U-H-F design problems almost singlehanded! And they're top performers at lower frequencies as well.

Small in size, their leads are short. But, in addition—their three grid leads make possible separation of excitation and neutralizing circuits, lowering common inductance, and thereby *greatly reducing neutralizing difficulties.*

Use of center-tapped filaments permits paralleling of filament leads for low inductance r-f feed. Reduced ratings permit operation up to 200 mc air-cooled, 300 mc water-cooled.

Two GL-8002-R's are used in the final amplifiers of both the G-E 3-kw frequency-modulation transmitter and the G-E 1-kw television sound transmitter.

GL-8002 and GL-8002-R are "sister" tubes of the GL-880, GL-889, and GL-889-R—all developed and introduced by General Electric, Schenectady, N. Y.

**GENERAL**  **ELECTRIC**

161-11

# Transformers for Television

## AMERTRAN EQUIPMENT Selected for N.B.C. TRANSMITTER on Performance Record

PIONEERS in the field of television are introducing a new form of entertainment. To insure its quick, wide-spread public acceptance, programs must be both dependable and of highest quality. Consequently transmitting equipment was selected with the greatest care . . . on its performance record.

Because of these circumstances, we observe with great satisfaction that extensive use has been made of AmerTran transformers, reactors, voltage regulators and modulation sets in N.B.C.'s television transmitter.

You will reap a greater return from your investment if you select dependable equipment. A television transmitter is not much different from regular broadcast equipment, and transformers which we supplied are of the same construction which we have used over a period of years for hundreds of radio and electronic application. Therefore, when considering transformers, specify AmerTran—it is the first choice of leaders\* throughout the entire electronic industry.



● Above—Ray Forrest (left) announcer, interviewing Alfred H. Morton, N.B.C. vice president, in front of television camera at the Republican National Convention.

● Right—One of the transformer vaults on the 85th floor of the Empire State Building. The AmerTran Transformers shown in this picture supply power to N.B.C.'s television transmitter.

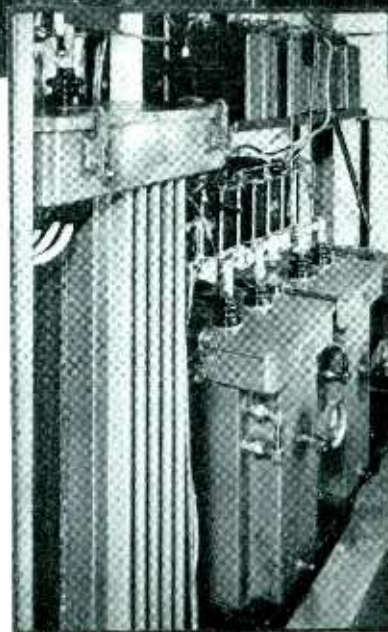

**Let us submit data on transformers for your needs. Equipment is available for all standard and special applications in both large and small quantities. Send for complete information.**

\*Names on request.



**AMERICAN TRANSFORMER CO.**

178 Emmet St.

Newark, N. J.

# AMERTRAN

**Manufactured Since 1901**  
**at Newark, N. J.**

## **Isolantite Insulators Increasingly Important TO AERIAL COMMUNICATION**

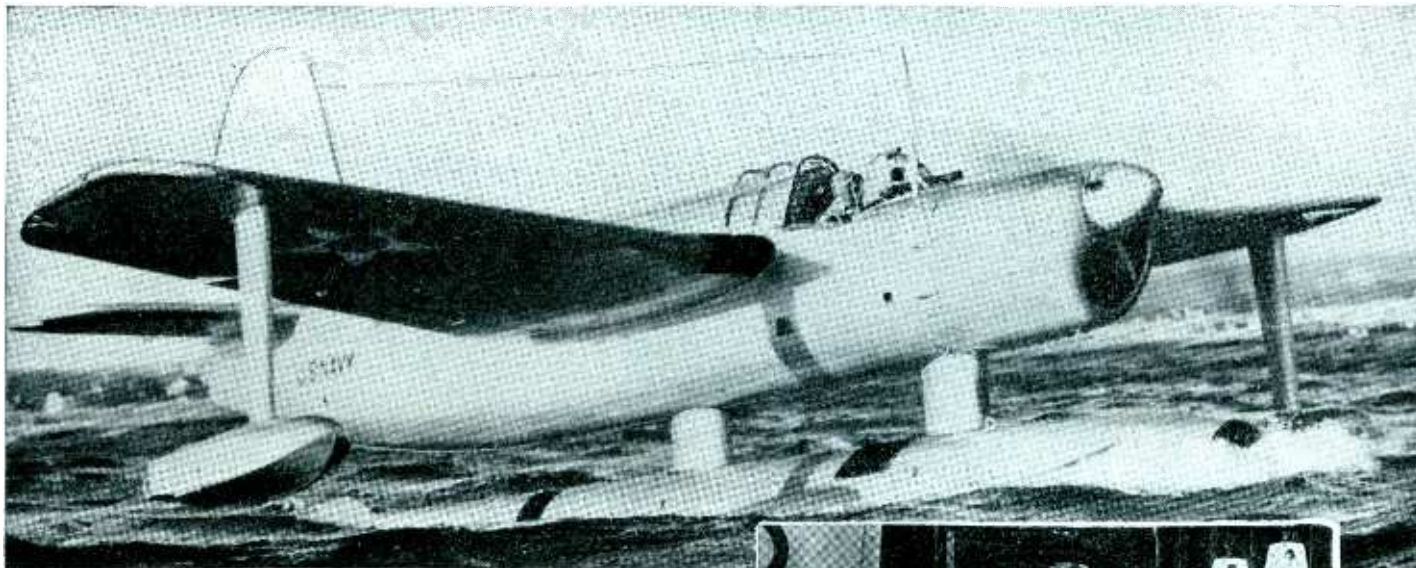

Visible atop this latest Scout Observation Seaplane are Isolantite Antenna Supports. These reliable, highly-efficient insulators for radio apparatus meet the United States Government's rigid specifications.

**I**SOLANTITE\* Insulators are unobtrusive—but vital—factors in the dependability and efficiency of modern aircraft communications, both military and civil.

Isolantite possesses great structural strength which does more than double duty: It assures mechanical protection against landing shocks and flying stresses . . . it permits small, weight-saving cross sections. This smallness gives an additional major advantage — it makes possible more efficient, longer range radio apparatus by reducing dielectric power loss. These excellent electrical and physical properties are practically unaffected by the extremes of temperature and humidity encountered in flying.

Among those who rely upon the superb characteristics of Isolantite Insulators are the United States Army and Navy Air Services, the Transatlantic and Transpacific Clippers, the commercial air lines, and business executives with private planes.

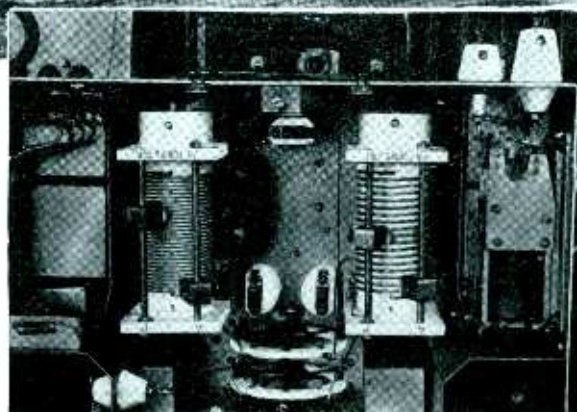

Typical installation showing the use of standard Isolantite Insulators in the radio equipment of a commercial plane.

Your requirements may call for high frequency insulators of special shape or streamlined section. If so, you will benefit by availing yourself of our experience in design of insulators.

\*Registered trade-name for the products of Isolantite, Inc.

# **ISOLANTITE**

## **CERAMIC INSULATORS**

ISOLANTITE, INC. FACTORY: BELLEVILLE, NEW JERSEY  
SALES OFFICE: 233 BROADWAY, NEW YORK, N. Y.

**For Your Industrial Electronic Needs**



*Approved*

## **PRECISION PRODUCTS**

This catalog can easily save hours of inquiry and letter writing delays. It may be a replacement you need for maintenance of equipment. It may be a specific part for test and experimental work in engineering laboratory. Or it may be a part that will become a fundamental of some product you plan to put into production.

Mallory manufactures a complete line of approved precision products that have innumerable applications in the aeronautical, automotive, electrical, geophysical, radio and industrial fields. It would be impossible to enumerate these products here; but they are ready for reference when you have the Mallory Catalog at your elbow.

Be sure that your engineering and designing departments know that the Mallory Catalog is available. They will find it especially helpful. Mallory's organization of 253 selected distributors gives splendid service. Each distributor is a leader in his community, maintains adequate warehouse stocks and has a staff well trained to serve your needs.

Write today for the Mallory Catalog of Approved Precision Products. It will be sent promptly, along with the address of the distributor nearest you.

*Send for it NOW!  
1940 Mallory Catalog  
of Approved  
Precision Products*



P. R. MALLORY & CO., Inc., INDIANAPOLIS, INDIANA • Cable Address—PELMALLO

*Serves the Aeronautical, Automotive, Electrical, Geophysical, Radio and Industrial Fields with . . . Electrical Contacts, Welding Electrodes, Non-Ferrous Alloys and Bi-Metals... Rectifiers, Dry Electrolytic Capacitors, F.P. (Fabricated Plate) Capacitors, Vibrators, Vitreous Resistors, Potentiometers, Rheostats, Rotary Switches, Single and Multiple Push Button Switches, Electronic Hardware.*



# CROSS TALK

► **TO ARMS . . .** While Congress ponders the weighty questions of conscription and of plant amortization and of excess profits taxes (and listens to the way the wind blows back home) the nation as a whole wonders why so little evidence can be seen that we are really getting down to brass tacks on this rearmament business. Most of the people, we believe, are convinced that a superior army and navy made up of regulars and trained men in reserve, well equipped with modern machines of war, with modern ideas of combat backed by the population with a strong spirit and a hard heart will be sufficient suggestion to any possible invader to stay at home. Most of us believe that weak people seldom attack strong people; and that a man with strong arms trained to the manly art seldom gets pushed around.

Readers of *Electronics* have a considerable responsibility in the awakening of America to the fact that we are not isolated in this world, that oceans are not real but only illusory barriers; for readers of *Electronics* are not only the means by which communication throughout the world brings people within almost instant touch with each other, but they are the means by which a modern protective fighting system will get its communication ears and eyes.

It is our responsibility, therefore, to insist that our representatives in Washington get down to brass tacks, that they take their eyes off the election calendar long enough to enact the proper legislation. It is our responsibility to see that the armed services first know what kind of communication equipment can be provided, what the

new art is going to be and not what the old art was; and having demonstrated what can be done, to produce what the services need at the utmost expedition.

► **M.K.S. . . .** Readers of *Electronics* will do well to get better acquainted with the meter-kilogram-second system of units internationally accepted but not widely publicized. Many do not know that with these units one can work out from first principles problems in antennas, electron optics, wave propagation, and what have you, using volts, amperes, ohms, and the other practical units from start to finish. The procedure heretofore has been to start with the c-g-s electrostatic system or the electro-magnetic system, then convert everything to volts, amperes, etc., in order to get equations for experimental checking or design. Sometimes it has been thought best to use both c-g-s systems in the same analysis, in which case it is a good man who can keep his wits about him. The m-k-s system is the one likely possibility of uniting all theoretical and experimental work with engineering in an arrangement which includes the units with which most electrical apparatus is actually graduated. A testimonial by F. B. Llewellyn in the October 1935 *Bell System Technical Journal*, page 634, who is a convert of recent years, can be read with value.

The m-k-s units were adopted internationally and some further steps taken before the dark cloud of war descended on the earth. There remains the matter of rationalization of Heaviside's contribution to the subject of

units; on this we only wish to point out that this question does not prevent any worker from making his own choice and obtaining the benefits of the new system now.

There are three items of literature which are outstanding. First, Harnwell's excellent text "Principles of Electricity and Electromagnetism" using the new system throughout; second, Jauncey and Langsdorf's little volume on the system; and third, Crittenden's recent survey of electrical units and standards in the April 1940 *Electrical Engineering*.

► **THUNDER . . .** Weather conditions have been ideal in the vicinity of New York City within the past month for anyone possessing an A-M and an F-M set to convince himself of the efficacy of FM on u-h-f as an antidote to natural static. Several times your editor has been aware that a rip-snorter thunder storm was going on only because the dog began to howl, said dog not liking thunder and lightning. This reminds us of Major Armstrong's statement before the Radio Club of America in January 1936 that in time the thunder coming through the window would be worse than the static coming from the loud speaker. This is definitely true, now.

We have one trouble, though. W2XOR emits vertically polarized signals; the others use horizontally polarized signals. This calls upon us to provide two antennas with some sort of switch; a distinct nuisance. The standardization bodies must handle this little problem after sufficient information has been gathered.

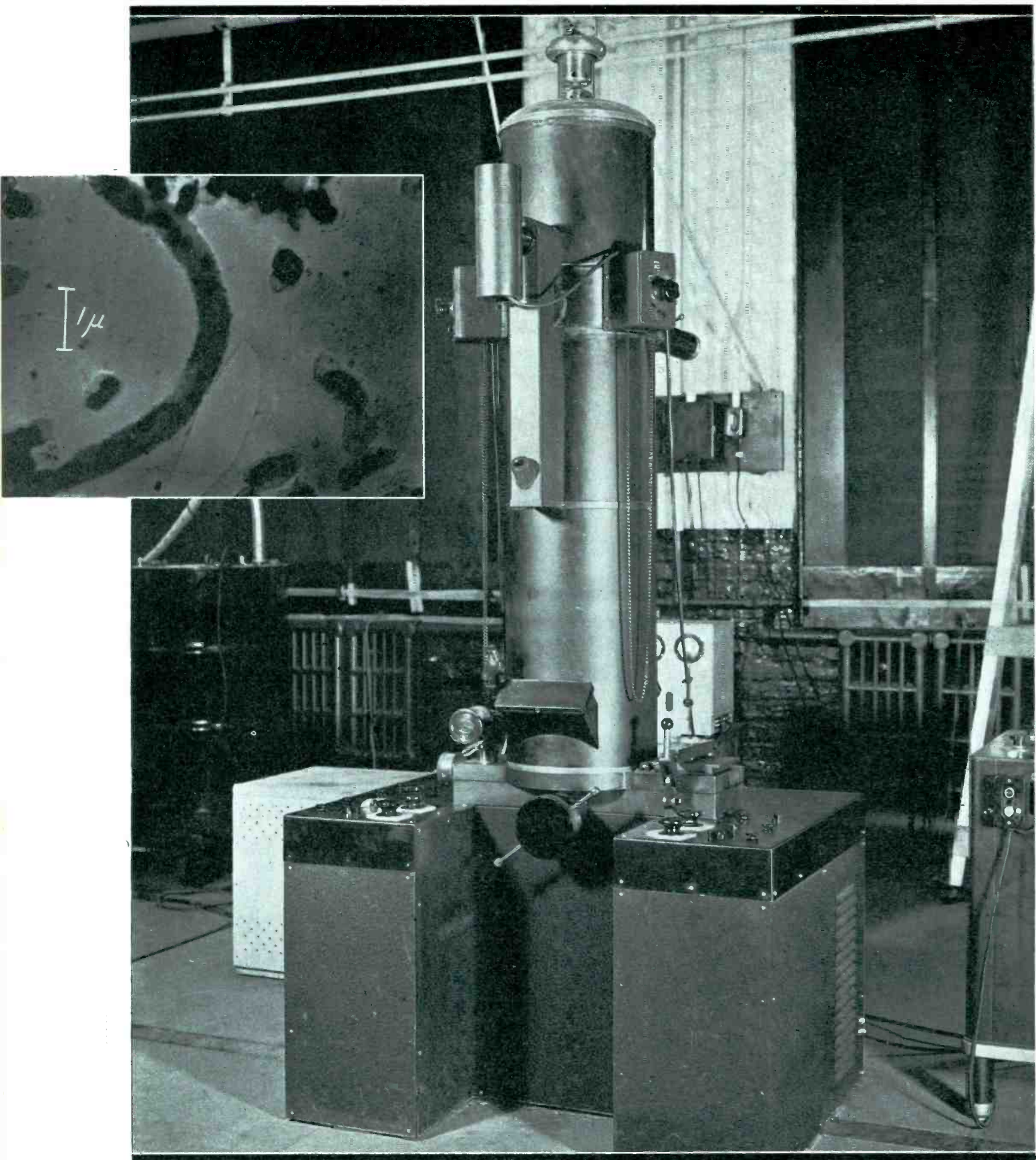

**Electromagnifier . . .** The useful magnification of this electron microscope, recently developed at the RCA research laboratories in Camden, exceeds that of the best optical microscopes by at least 100 times. The inset shows an electron-optical image of the micro-organism which causes whooping cough. The scale mark is one-thousandth of a millimeter long



# FM-105 HOURS PER WEEK

Using the first of the new "synchronized" transmitters, WOR's f-m station stays on the air daily from 9 in the morning to midnight. The 1000-watt installation represents a coordinated design to make the most of the wide-range, low-noise, and low-distortion advantages of f-m transmission

**T**HE inauguration of W2XOR, the frequency-modulated outlet of WOR, the Bamberger Broadcasting Service, in New York, is worthy of special mention on several counts. It is one of the few f-m stations in the country operating on a schedule as extensive as that of the usual standard broadcast station, 15 hours per day, 9 in the morning to midnight, seven days a week. With this expanded service have come the usual problems of providing the necessary staff and working out testing and maintenance routines, which have not yet been faced by the majority of f-m stations now operating. In the second place, W2XOR employs a new type of transmitter, based on the principles recently revealed to the I.R.E. Boston Convention by J. F. Morrison of the Bell Telephone Laboratories. The transmitter is, in fact, the first of its type put into regular broadcast operation. Thirdly, the entire installation, studios, speech equipment and program lines, has been designed for low distortion, wide dynamic range, and extended frequency response commensurate with the capabilities of the transmitter itself. The operators claim in fact that there is no receiver or monitor now available commercially which can do justice to the transmission. This sounds a bit on the prejudiced side, but the claims are backed up by impressive measurements. For example, a recent distortion run through the range from 50 to 7,500 cps (the limits of the distortion meter available), taken overall from microphone, through the speech input circuits, program lines, limiting amplifier, transmitter, radiator, and monitor showed an overall distortion of 1.1 per cent at full modulation, that is, at 75-kc swing each side of the center frequency. This is low distortion indeed, considering

the fact that the entire transmission system was measured in the process.

The transmitter is located on the 42nd floor of the building at 444 Madison Ave., New York, in a large room directly beneath the roof. The coaxial transmission line to the radiator extends directly from the transmitter upward through the roof, where it is supported on a 53-foot pole and terminates directly in a vertical half-wave rod of the coaxial radiator type. The antenna height is about 620 feet above sea level. The transmission line is  $1\frac{1}{8}$ ths inch in diameter, although  $\frac{3}{8}$ -inch would have been sufficient, but as the supervisor says, "that last 0.2 db was worth it." Five other coaxial lines lead to the roof, one for f-m transmissions of experimental nature of 26.3 Mc, one for a u-h-f cue-channel a-m transmitter, one spare, and two small lines for receiving purposes. The use of vertically polarized waves is a departure from usual f-m practice. The coaxial antenna was adopted because it concentrates energy in the horizontal plane in a very simple and direct manner. Moreover, vertical polarization makes possible the use of a simple non-directional receiving antenna, that is, a vertical half-wave rod.

#### *Studio and Speech Circuits*

Studio Number One of WOR at 1440 Broadway has been fitted with a new console to suit it particularly to the needs of f-m broadcasting. All of the transmission circuits from microphone to telephone line

The three vertically-polarized coaxial antennas atop 444 Madison Avenue, New York. The center radiator is used for f-m transmissions on 43.4 Mc, the others for low-power developmental transmissions

terminals are flat within one db from 30 to 15,000 cps, with noise better than 60 db below maximum operating level. Stabilized feedback has been used to reduce the distortion to negligible proportions. Six microphone channels and mixers, the usual regular and emergency master gain controls and a standard "vu" type volume indicator are provided. A transcription turntable is located directly to the operator's right.

The monitor speaker system is unusual in that three separate speakers are used, a low frequency speaker, and two high frequency horn-type tweeters mounted in one enclosure. This monitor speaker is mounted on the wall of the transmitter room.

The lines from studio to transmitter have been equalized to match the rest of the system. Two duplicate lines over different paths, both

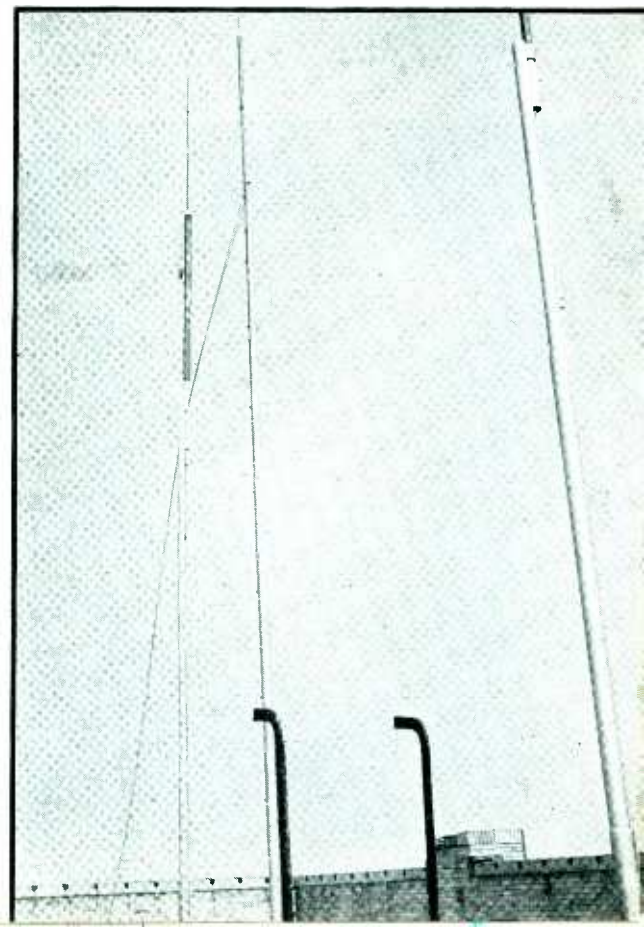

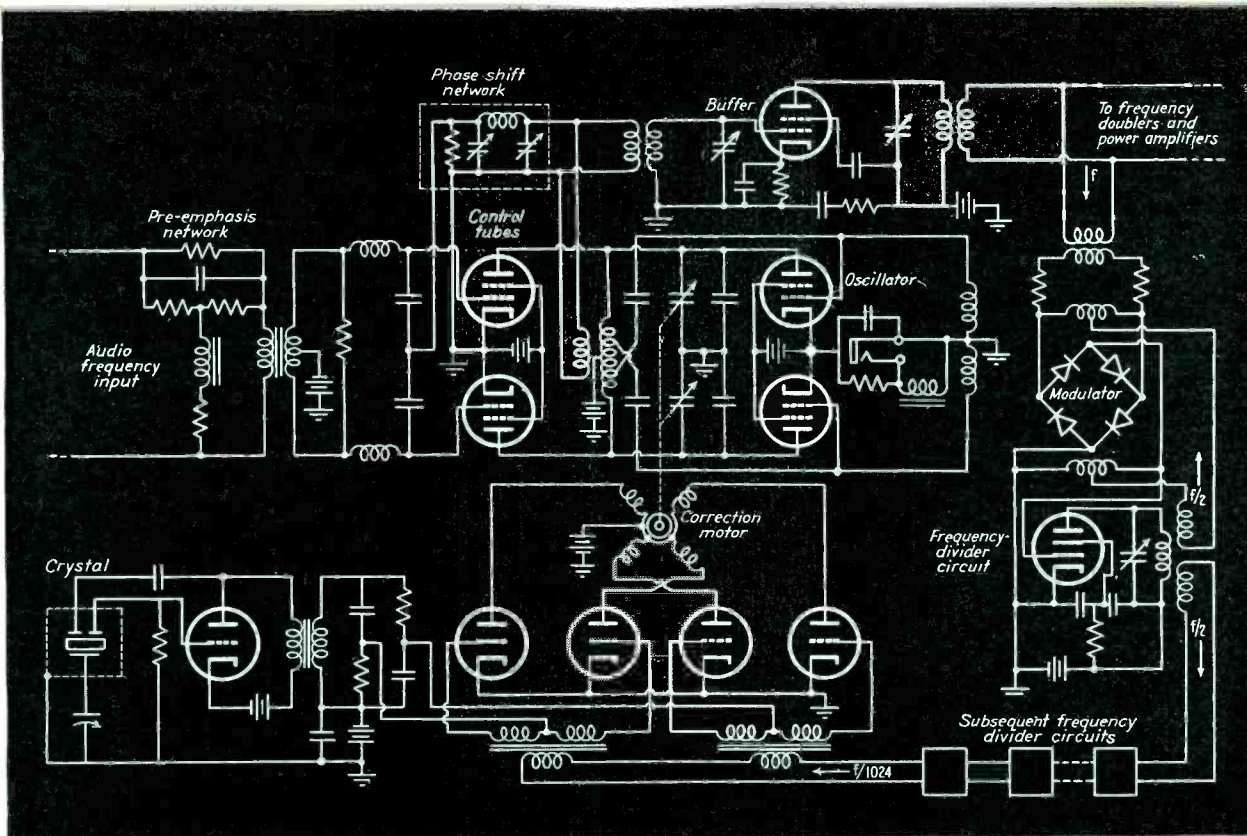

Simplified diagram of the modulator, oscillator, and frequency-control system of the new transmitter, built by Western Electric from designs by the Bell Telephone Laboratories

about 3 miles long, are used. The measured characteristics are rather remarkable: within 0.4 db from 30 to 15,000 cps, 2 db to 20,000 cps, and 18 db to 30,000 cps.

#### The Station Setting

The station room itself is in the form of an L, 90 feet long by 16 feet by 40 feet, with a 20-foot ceiling. On the same floor are located the controls and motors for the elevator system of the building, so a double-door acoustic lock has been built to eliminate noise from that source. The walls of the transmitter room have been thoroughly treated acous-

tically with obliquely-set panels of sheet rock, covered with high- and low-frequency absorbing material. The result is that the transmitter room is quiet and adequate acoustically to allow monitoring the output of the transmitter.

The transmission equipment consists of a console, containing amplifiers identical to those in the studio console, four racks for speech input and test equipment and the transmitter itself, which is built in two sections, one for frequency control and modulation, the other for r-f amplification. The speech input equipment contains, in addition to the usual amplifiers, a limiting amplifier which is set to prevent modulation beyond the 75 kc swing prescribed by the F.C.C. This amplifier is of a new design, and has distortion so small that it cannot be detected.

Beside the speech rack are a short-wave receiver, a heterodyne fre-

quency meter, a 400-cps tone generator and a frequency-limit monitor. The heterodyne frequency meter is used to check the frequency deviation of the transmissions in the following manner: the transmitter, unmodulated, is brought to zero beat with the frequency meter to establish the average or center frequency. Then 400-cps tone is applied to the transmitter. At this low frequency, the limits of major sidebands are located at the edge of the frequency swing. The limits are established by tuning the frequency meter each side of the previously established center frequency until no beats are heard. These points are taken as the deviation limits of the transmission, for the particular



Alfred Wallenstein and J. R. Poppele, Chief Engineer, examine the innards of the new console installed in WOR's Studio One especially for f-m broadcasting

Charles Singer, technical supervisor, before the new f-m transmitter. The bay at the left contains the modulator and frequency-control circuits, that at the right the frequency multipliers and output stage

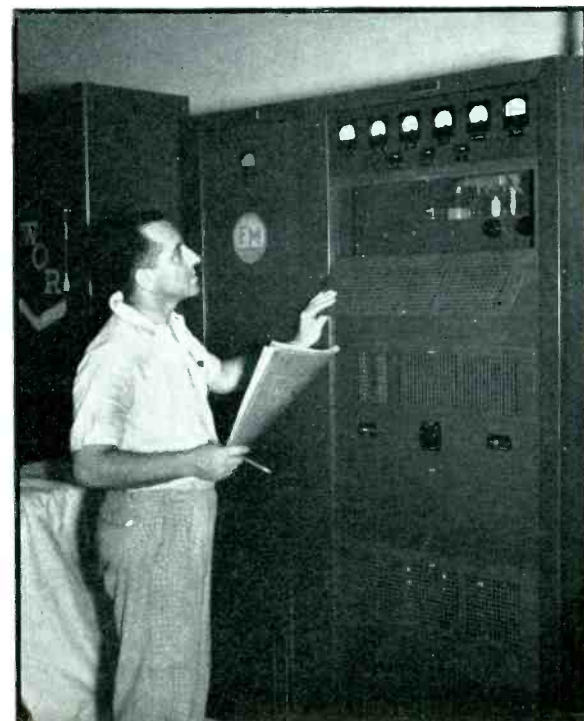

volume level employed during the measurement. The measurement is repeated for several readings of the volume indicator to establish the relation between audio level and frequency swing, which must be linearly related from zero to the full swing of 75 kc.

The station contains a fully equipped workbench, tools and supplies, as well as a movable measurements table. A signal generator, vacuum tube voltmeter, Q meter, tube checker, decade resistance boxes, utility power supplies, distortion meter, and continuity test meters are the standard test equipment. Two spare tubes for every one in the transmitter are kept on hand.

#### *The Transmitter Proper*

The transmitter specifications reveal it to be a very highly engineered job. The frequency stability is plus or minus 1,000 cps for any assigned carrier frequency in the range from 42 to 50 Mc, and this stability is achieved by the use of a single non-temperature controlled crystal. While this stability is well within the requirements set by the F.C.C., further stability may be obtained by the use of temperature control. The frequency response is flat within plus or minus 1 db from 30 to 15,000 cps. The frequency deviation limits are plus or minus 150 kc. At the F.C.C. recommended value of plus or minus 75 kc, the harmonic distortion is less than 2 per cent throughout the range from 30 to 15,000 cps, the measurement including all harmonics up to 30,000 cps. A program level of 0 vu, or a single frequency signal of plus 8 vu, is sufficient to produce a deviation of plus or minus 100 kc. The phase noise is down 70

db from the modulation level corresponding to plus or minus 100 kc deviation.

The principle employed in the transmitter differs from the two designs previously available, the Armstrong modulator and the Crosby modulator. The Armstrong system, it will be remembered, obtains frequency stability by the use of phase modulation of a low-frequency crystal-controlled source, followed by frequency multiplication. The W2XOR transmitter (using the principle developed by the Bell Laboratories) on the other hand uses direct frequency modulation of a modified Crosby-type oscillator, and obtains frequency stability by frequency dividing the output of the oscillator and comparing frequency-divided signal with the output of a low-frequency crystal. This principle, by the way, has been in use for some time for the synchronization of broadcast transmitters via telephone line connections.

The diagram shows the basic circuit used for frequency modulation and frequency control. The audio frequency input at the left, having passed through a frequency pre-emphasis circuit, feeds two balanced reactance control tubes. These control tubes are fed r-f in their cathode circuits, the r-f being supplied by the oscillator tubes and tank circuit next to the right. The r-f voltage is passed to the reactance-tube cathodes through a phase-shift network which insures that the r-f plate-to-plate voltage across the reactance tubes is 90 degrees lagging the current in the oscillator tank circuit. Hence the reactance tubes act as a capacitance, the value of which is controlled by the audio applied to the reactance tube grids. The oscil-

lator is thereby frequency modulated. Any tendency to amplitude-modulate the oscillator (which occurs if the reactance tube output voltage is not exactly 90 degrees out of phase with the tank coil current) is inhibited by the use of negative feedback in the oscillator circuit, introduced by a choke in the common cathode circuit of the oscillator tubes. The output of the frequency-modulated oscillator is then passed through a buffer stage to three doubling stages the final stage of which produces the desired carrier frequency (in the case of W2XOR this is 43.4 Mc). The doubling stages are operated in class C, as is usual in f-m transmitters. The final stage employs two air-cooled type 357A tubes in push-pull.

The frequency control is obtained by taking a portion of the output of the buffer stage (at the input to the frequency multiplying stages) and passing it through a succession of ten two-to-one frequency dividers, which introduce a frequency division of 1,024 times. At the output of the final frequency divider the signal is thus reduced to the neighborhood of 5,300 cps. The output of a crystal controlled oscillator operating at about 84 kc is likewise frequency divided to the neighborhood of 5,300 cps. The two 5,300-cps sources are applied through balanced amplifiers to two windings of a split-phase induction motor, whose rotor will respond to a rotating magnetic field. The rotor is connected mechanically to the balanced tuning capacitors in the tank circuit of the modulated oscillator so that it may correct the frequency whenever necessary.

The frequency-control circuit  
(Continued on page 61)



Left, A. J. McCosker of WOR and F. R. Lack of Western Electric are at the microphone, at the inauguration of full-time service

The Major pushes the button. E. H. Armstrong seated at the transmitter console puts the station on the air as Messrs. Poppele and McCosker look on



# WEAF, Port Washington

**I**T has been said many times, and truthfully, that there are penalties attached to being a pioneer. This axiom applies with force to the broadcasting business, because the art is in a rapid state of flux. What was good practice 15 years ago is just a mistake today. The pioneer making the best use of money and brains to construct a station usually finds that the competition, starting at a later date, is able to get better results possibly with less brains and less money. It's disheartening but true. So the pioneer finds it necessary to pull up stakes and start over, making use of the best current practice, and thus put his station back at the top of the heap.

All of which is the plot for the latter-day story of WEAF. Make no mistake, WEAF is not now, nor ever has been, a second-rate station. But a comparison of signal strengths in important areas in New York City revealed that competing stations were consistently laying down a stronger signal. The reason was not hard to find. More selective receivers had permitted the location of stations closer to New York than had been considered feasible in 1927 when WEAF was established at its Bellmore site. Directional antennas had added to the effectiveness of the newer stations.

The new station building and the cooling pond as they appeared early in August. The station was scheduled to begin testing by mid-September

**When a pioneer broadcast station moves, the move usually is from a location outmoded by time to a location as nearly optimum as the engineers can find and the executives can acquire by negotiation. The transfer of WEAF from Bellmore to Port Washington, Long Island involved many preliminaries, resulted in an excellent technical solution of the problem**

So the need to relocate WEAF became apparent and plans were made for a move to end all moves. In other words, a search was started for a location so good that it would stand the test of time.

For a while a definite decision was delayed by the possibility of 500 kw operation, since a location optimum for 50 kw would not be optimum for 500 kw, not by quite a few miles and several db of selectivity. But when 500 kw stations were officially frowned down by the F.C.C., there was no further reason to delay. The search for a location started with maps and ground characteristic data, and led after several weeks to two possible locations, one in New Jersey, the other on the north shore of Long Island. After considerable negotiation, options were obtained and pre-

liminary surveys, using a 100-watt transmitter, made to compare the two locations. The result pointed definitely to the Long Island location, and thereafter all efforts were directed toward obtaining the necessary unencumbered title to the land. The negotiations make in themselves a story reminiscent of Homer's Iliad. In this case, the part of Homer was taken by an engineer, Ray Guy, chief of the Radio Facilities Section, who conducted the negotiations with the aid of the legal department. The final result was that nearly \$80,000 was spent for 50 acres of land. This is believed to be the highest price ever paid for a broadcast station site. The reasons are two: (1) the land is located in a township noted for Cadillac and Lincoln cars as standard equipment, and (2) the N.B.C. authorities considered it well worth the price. The location is some eight miles nearer to the center of New York than Bellmore (16 miles as against 24 miles, to Columbus Circle, New York). But most important is the fact that the path from the new station to Manhattan Island lies directly over the western end of Long Island Sound. The high conductivity of salt water, so important in ground-wave propagation, is thus available for extending the high signal contours well

One of the towers viewed through the steel-work of the other. Separate gas-filled coaxial lines will feed the towers with signals of equal amplitude

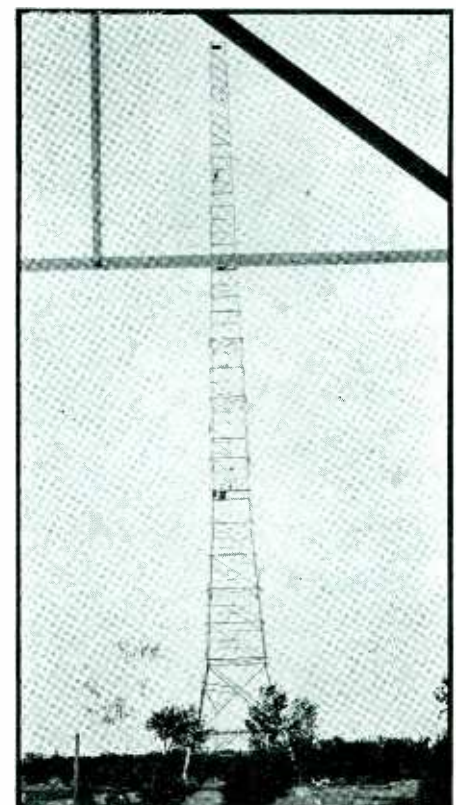

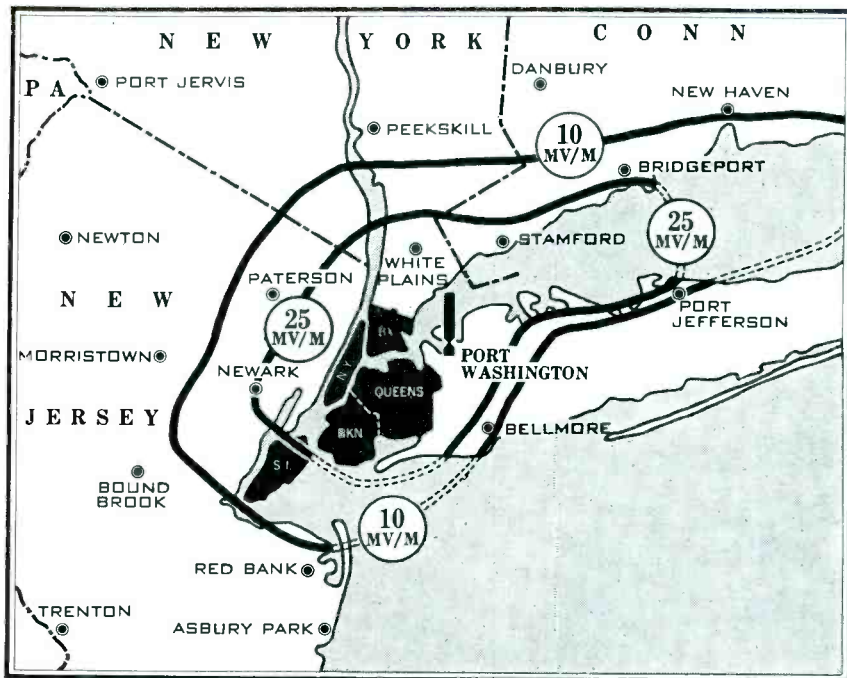

Predicted signal contours of the new transmitter from the new location, which is 8 miles nearer New York than Bellmore and adjacent to a salt-water signal path directly to and through regions of dense population

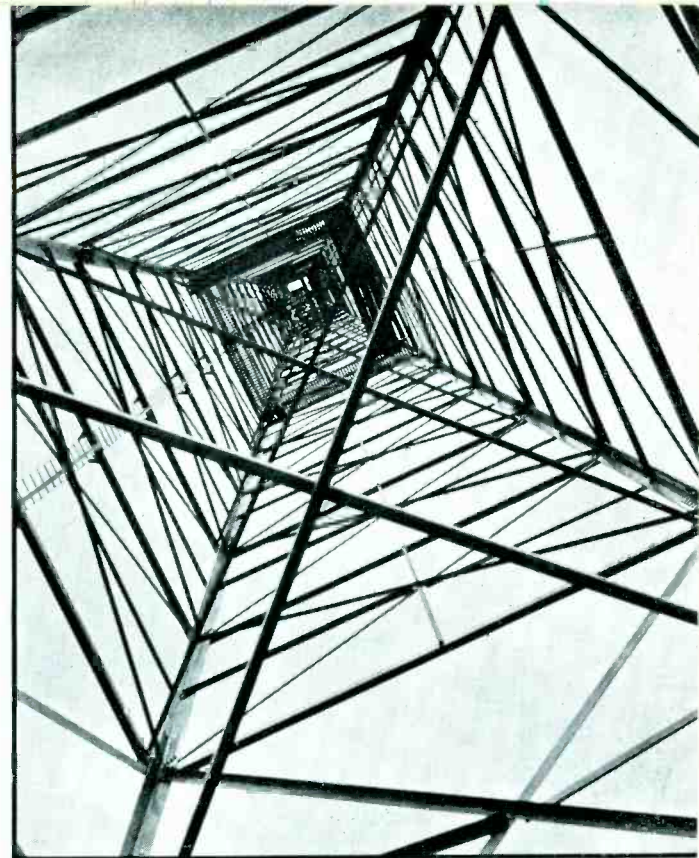

Looking up through one of the two towers which form the directional array. The array serves to produce an increased signal in the direction of New York

into the city, while the six-mile separation across the Sound prevents excessive signal strengths (relative to the F.C.C. limitations) in the suburban regions of Westchester.

The location was, in the opinion of the N.B.C. authorities, truly in the optimum class. But getting the necessary permission and clear title was a horse of purple hue. It took 72 weeks of cajoling, speech making to local civic and patriotic bodies, conferences with lawyers, land agents, title investigators, real estate operators, revision of zoning ordinances, dealing with local gov-

Headache experts: O. B. Hanson and Raymond Guy, Chief Engineer and Radio Facilities Engineer respectively of N.B.C., relax on a tower foundation after months of negotiating for necessary rights

ernments and of all things a sand-digging company before the way was cleared.

Then came the matter of the tower radiator. A single tower of some 740 feet was proposed to the F.C.C., who referred it to the Civil Aeronautics Authority, who in turn referred it to every organization that could be concerned, in accordance with the usual procedure. A nearby airport, maintained by a large transoceanic air transport company provided certain complications the upshot of which was a reduction of the maximum tower height. Since the full high field intensity is not required over Long Island Sound and the ocean to the east, the new station will use a two-tower directional array. This will increase the field moderately toward New York and inland where it will do the most good without depriving other areas of service. The antenna will produce most of its field in the North, South and West, reducing the field over the salt water to the East. Actually the power gain toward New York is about 1.55, corresponding to a signal strength gain of about 1.23.

#### The Transmitting Equipment

The specifications of the transmitter leave little to be desired, judged from any viewpoint. The two program telephone lines, routed

over different paths, are flat from terminal to terminal within 0.8 db from 30 to 10,000 cps in one case and from 30 to 9500 cps in the other. The noise is 70 db below the maximum modulation level, and the transmission loss is 8 db on one circuit, 11 db on the other. The transmitter is flat from 30 to 16,000 cps, 2 db down at 20,000 cps. The noise level is -65 db. Distortion over the lower section of the audio range is less than 2 per cent at 100 per cent modulation. The frequency stability is such that a deviation of 5 cps is unusual, and plus or minus 1 cps is the normal range.

The transmitting equipment itself has been assembled with performance as the first criterion, but at the same time with engineering economy. The task of moving the transmitter from Bellmore to Port Washington was complicated by the fact that the Bellmore transmitter could not be taken off the air until the Port Washington installations was complete, tested and thoroughly shaken down. This would have meant the purchase of an entirely new transmitter for the new station, but for one fortunate circumstance. The high power 50-kw stage and rectifier power supply of an R.C.A. type 50B transmitter were available at station WENR, Downer's Grove, Chicago, left over from a changeover made there a

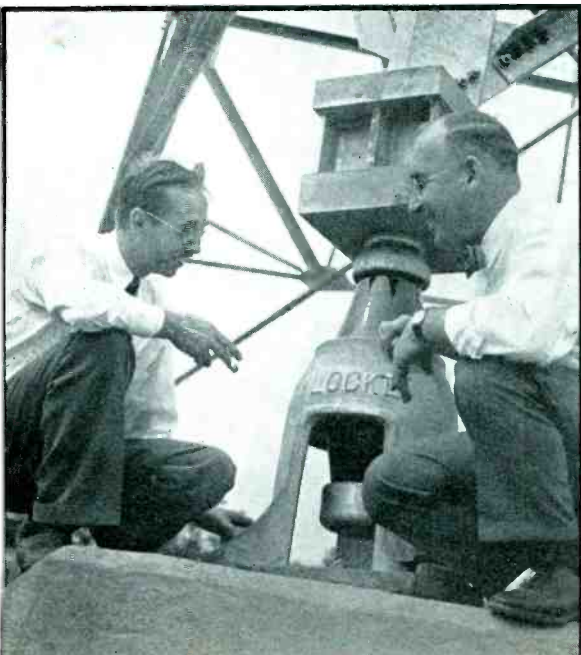

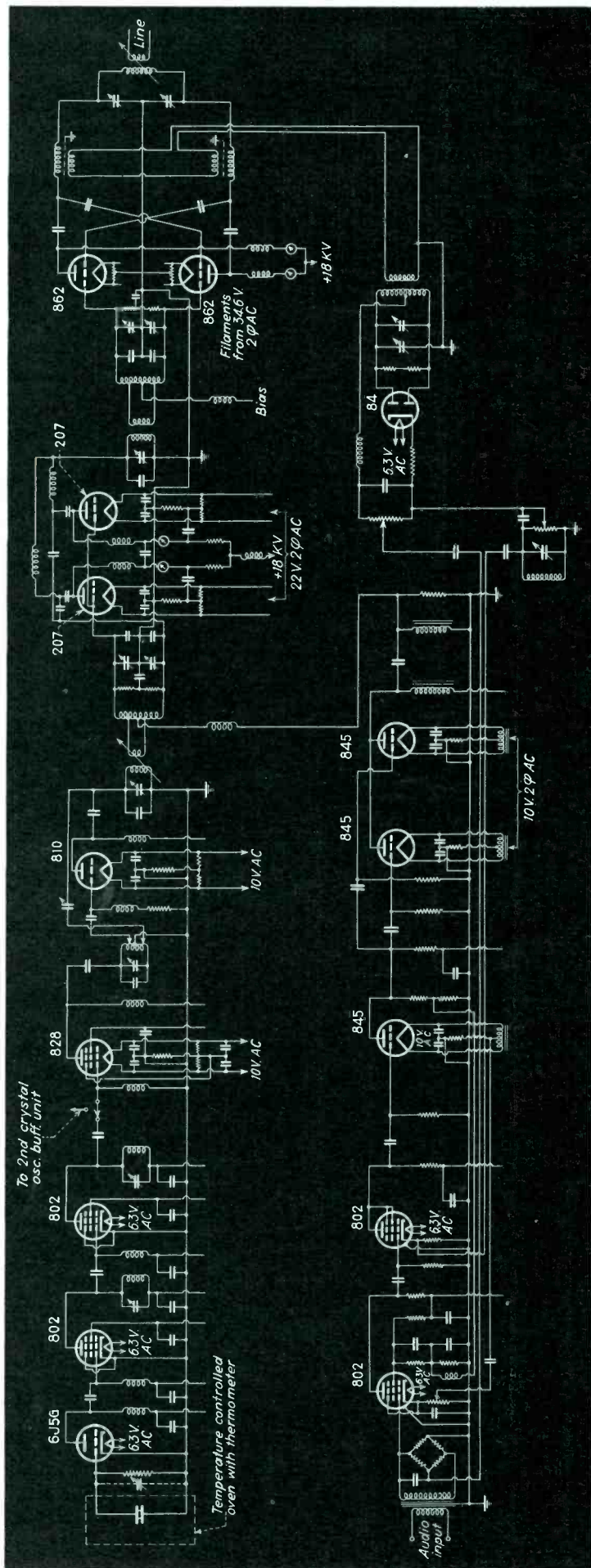

Simplified schematic diagram of the new WEAF transmitter. Grid-modulation, overall feedback, a-c filament supply throughout, and new tube types mark it as a thoroughly modern adaptation of the 50B equipment

year or two ago. An extra exciter unit was available at Bellmore in the auxiliary transmitter there. By using the extra exciter at Bellmore, the 50B exciter was freed of duty so that it could be transferred to Port Washington. By combining the two, a complete type 50B transmitter was secured, similar to that used as the main transmitter at Bellmore.

Many things have been done to modernize the 50B equipment. Among the most important changes are changes in tube types to reduce tube cost, installation of a-c filament supply in all stages, and the use of grid modulation of the 5 kw stage rather than plate modulation of the preceding 300-watt stage. The filament circuits of the two tubes in the 5 and 50 kw stages are in phase quadrature and the two stages are 45° apart in phase, giving the effect of four-phase excitation. The 5-kw driver stage uses 207 tubes which replace the 892 tubes formerly used. Two type 845 tubes are used in the modulator, replacing a pair of 849's. By these and other changes in the modulator and modulated r-f amplifier, they are thus made considerably simpler, the performance improved, and a saving of about \$300 in tube cost effected.

The tube line-up of the transmitter is shown in the accompanying schematic diagram. The 6J5G crystal oscillator is followed by two 802 buffer stages, an 828 first r-f amplifier and an 810 second r-f amplifier. The 810 drives the pair of 207 tubes which are grid modulated and which in turn drive a pair of 862 tubes in the 50-kw output stage. The speech system, from the audio input, consists of two 802 speech amplifiers, an 845 driver, and a pair of 845's in parallel as the modulator. Overall inverse feedback from the transmitter output to the audio input is accomplished by picking off modulated r-f from the plate circuit of the final r-f amplifier, rectifying it in a type 84, and applying the audio in reverse phase to the input circuit of the first 802 speech amplifier. About 30 db of feedback is normally used.

---

# CHALLENGE TO INDUSTRY'S PATRIOTISM

## *Calls for Plain Speaking*

---

IT is a pity that the greatest national defense effort in American history had to be made during a presidential election campaign. For a modern defense effort involves an intensely practical industrial project, while an election campaign involves an intensely emotional political propaganda. And those two don't mix.

That, as I see it, is the chief reason for the welter of claims and denials, charges and counter-charges that have been getting in the way of contracts for planes, tanks, guns and all the rest of the armament for which the American people are so nervously peering down the road.

We are told that the managers of industry, smarting and suspicious under the repeated attacks of government officials for some years back, have been reluctant to assume the abnormal risks of defense contracts without commensurate safeguards, and that the politicians who must authorize those safeguards have been reluctant to do anything that might be construed as letting down the bars for unscrupulous business men to exploit the national emergency. For the one, the business risks of full speed ahead have been too great; for the other, the political risks of full speed ahead have been too great. So we don't go full speed ahead.

This is not written to increase that clamor of recrimination on either side. On the contrary, it is an appeal for some decent and thoughtful consideration on the part of all concerned—consideration for the urgent needs of the nation, for the problems and responsibilities of both the politicians and the industrialists, for the elementary principles of prudent business management, and for the good opinion of the man on the street. He is neither a politician nor an industrial executive. But his hide and his pocketbook are at stake in the national defense program—and he knows it. He has a right to the low-down on what is going on. And if he is left in ignorance or deliberately deceived, for the sake of either political or business whoopee, the payoff will be mighty poisonous political medicine for the politicians and equally poisonous business medicine for the business men who may be responsible.

\* \* \*

The plain stark fact, to be faced squarely by us all, is that the national defense program is an emergency project—a desperately urgent emergency project.

As in every emergency that confronts a democracy, we are harassed by a confusion of counsel. As always, some of the confusion arises from honest but conflicting judg-

ments, some of it from ignorance or muddy thinking. But, unhappily, much of it reflects the deliberate purpose of self-seekers to fish in troubled waters—to capitalize the conjunction of a national emergency and a political campaign to boost their own interests. Already the charge that American business men are unpatriotic and interested only in profit has been put out as a smokescreen to cover up deficiencies for which business men are in no way responsible.

Now the man on the street finds it hard to see through this maze of excited contradiction. Not because he isn't smart—the average American can think straight enough *when he has the facts*. But in this case the facts are obscure and complicated—they have to do with matters that are strange to him. And to make it worse, at the height of his confusion, raucous voices constantly assail his ear with "simple" explanations of it all. But, as so often happens, most of these "simple" explanations make the matter a lot simpler than it really is.

\* \* \*

Consider, for example, the cry that "industry refuses to get busy on national defense until its profits are guaranteed". Very clear and simple, to be sure; but also very false. The charge that American capital is "on strike" in the hour of national need. As silly as it is simple. The assertion that our manufacturers "won't even talk with a government anxious to place orders with them, without large financial concessions", and that "American corporate industry refuses to expand its resources for defense until it receives immunity from proper taxation". The resounding demand that we "conscript wealth as well as men"—whatever that may mean.

Particularly political has been the attack on the aircraft industry. It has been made to appear that aircraft manufacturers were instituting a sit-down strike because, in their greed for profits, they demanded more than 8%. Actually the 8% was not a net profit at all and the only concern of the manufacturers was to fight against incurring losses under the 8% limitation. And army and navy officers have sustained the aircraft manufacturers' viewpoint.

The air is full of explanations which, however simple they may sound, do not explain. And in most cases, I am convinced, the purpose of those who offer them is not to explain but to inflame. Those who try honestly to explain these issues from either side, find it impossible to do the job in such ringing phrases.

As I have said, our country has been caught short. As

a result, there are many reasons for the confusion and controversy. The plain fact is that we can produce our war equipment by only two means: (1) by converting the industries of peace into the industries of war, so far as that is possible; and (2) by building from scratch the new facilities we need to supplement them. In other words, we must create—with desperate haste—a new industry in America—an armament industry.

Right there is the crux of the problem that now confronts the industrialist sincerely trying to equip himself for his part in national defense. For this new armament industry is not the ordinary business risk against which he has learned to weigh the interests of his employees and his stockholders. It does not deal with familiar products and processes. It is not continuous—at least it has not been heretofore in this country—and it may fold up as suddenly as it has opened. It cannot hope to serve thousands of potential customers: it has but one sure customer—the United States Government—and wielding the sovereign power that customer can do just about as it pleases with respect to its needs and demands. Which means that not even this one is a *sure* customer.

\* \* \*

No more unfair or deceptive charge ever has been leveled against American industry and American business men than the accusation of being unwilling to take the normal business risks of the defense program. The risks they are trying to minimize—they cannot possibly avoid them all—are very special and extraordinary risks indeed. So clearly is that true, that I doubt very much whether such questions and charges ever would have risen were it not for the fact we are engaged in a political campaign.

Already some of industry's great units have gone ahead with the building of new facilities, the purchase of special materials, and the actual production of armament in the face of all risks, gambling that their government eventually would work out some reasonable plan to protect them against excessive loss. Others, doubtless will follow suit.

But many other companies, for one reason or another, are not in position to do that. So before they begin to expand their facilities to handle defense contracts, they have asked their *only potential customer for those new facilities* to guarantee them—not excessive prices, *not* exorbitant profits, *not* immunity from taxation, as we are being told, but simply against the excessive losses that may result from very extraordinary conditions.

\* \* \*

As this is written, it looks as though the legislation and the rulings necessary to accomplish this purpose soon will be forthcoming. Thoughtful and responsible officials of the government understand the situation and what is needed. But, unfortunately, their understanding and action will not quiet the professional business-baiters. So long as those gentlemen have their own interests to serve, so long as political excitement makes it easy to whip up public demand for a scapegoat to atone for disappointing progress with the defense program—just so long will the business-baiters find a receptive audience for their criticisms.

All of which suggests that business men must carry at this time a double responsibility, in addition to their

obvious obligation to do the very best job they know how on their individual parts of the defense program.

The first of these added responsibilities is, of course, to avoid any possible basis for the charge that industry is exploiting the defense program in behalf of excessive profit, unfair treatment of labor or any other unworthy self-interest. The second is to see that the man in the street knows and understands all that I have tried to set down in the foregoing.

For the man in the street is deeply involved in all this. He is "in the street" only to the political orators. To the rest of us, he is the man in the factory, the man on the truck, and the man behind the orders that industry fills. In short, he makes up this living American industry on whom the politician's charges spatter. As an employee he has a stake in the solvency, the security, and the reputation of the very plants at which criticism may be directed. Knowing the facts, he can answer the critics so far as his own plant is concerned and can see how the same kinds of facts apply to all industry. If he is a customer, suffering inconvenience as a result of the plant's service to national defense, a knowledge of the facts behind the plant's problems will help to make him a defender rather than a critic of responsible business management. If he is a neighbor in the community, the facts will equip him to be an interpreter of industry's problems to the people of the home town.

\* \* \*

In this national defense effort, business enters into a new partnership with government, but, more importantly, into a deeper partnership with the American people. It is more than ever essential that it take all of the American people into its confidence, beginning with the people in its plants and going out through the ranks of its customers and its community neighbors to show them that they have a common interest in seeing that the task of national defense is undertaken in the American way.

As we all know, there are in this country some people who would like nothing better than to see American industry fail in this supreme test of service to the nation. They will watch with jealous eyes every move of every company that is engaged on a defense job. They will disparage its achievements, exaggerate its shortcomings, and distort its motives. For they would like to make over American industry to their own pattern, and they'll never have a better chance to get started with it than has been opened up by the national emergency. Or so it looks to them.

So, great as are the business hazards of the defense program for the individual business man, even greater hazards are involved for American industry as a whole. But, knowing the temper of American industrial leadership as I do, I am confident that it will handle its defense assignment with credit to itself and with great advantage to the nation that it serves—whether in war or in peace.

To help in that supreme test is the opportunity and the privilege of the McGraw-Hill organization.

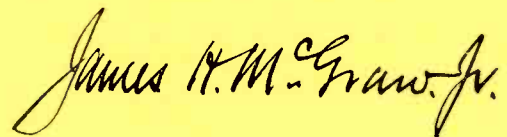

President, McGraw-Hill Publishing Company, Inc.

*This message is appearing in all McGraw-Hill industrial and business publications, reaching over a million readers.*



# NEW STUDIOS for C. B. S.

Controlled acoustics are a feature of C.B.S. studios in the former Juilliard School, in New York, which were constructed to meet the ever present demands of radio performers for more space for rehearsals and on-the-air performances

**T**HE trend in recent years toward shortening the length of broadcast programs has necessitated a large increase in the number of studios available for production. Since the demand for studio space for rehearsal as well as actual broadcasting has exceeded the supply, it has been necessary for the networks to rent theaters and other space suitable for the purpose. But this has not always been an ideal solution. Faced by this problem, the executives of the Columbia Broadcasting System decided in 1939 to design and construct a building in New York to house a number of new studios. However, it was decided to continue to broadcast programs, in which large studio audiences must be handled, from nearby theaters.

It was fortunate that directly across the street from the C.B.S. headquarters building at 485 Madison Avenue there was space available, in a building which had been the headquarters of the famous Juilliard School of Music where many of today's radio artists received their musical training. The building was acquired by C.B.S. and almost completely rebuilt to care for the specialized requirements of a group of broadcast studios. Floors were raised and lowered and columns removed to provide space for two large studios, designated as numbers 21 and 22, which occupy the lower portion of the structure. These studios, which are 67 by 44 feet and 18 feet high, are placed one directly above the other on the first and second floors. The floor of studio 21 is about 12 feet below ground level. The remaining five studios are located on the upper floors. Also located within the new building are an experimental studio and a laboratory where research work is to be carried on to improve

the technique of broadcasting. The new studio building is connected to the main C.B.S. building by means of a conduit under 52nd St. which carries the audio, telephone and power lines and air conditioning water pipes.

The major portion of the work-space does not require direct daylight and would be troubled with noise resulting from direct openings to the street. Therefore, the main facade presents a surface unbroken by windows up to the sixth floor. There is no extraneous ornamentation, no gingerbread. The lower portion of the facade is of gray and blue matte glazed terra cotta with the entrance and marquee of stainless steel. A concealed lighting system illuminates the entrance and marquee at night. The upper portion of the building is covered with a hard vitreous terra cotta which is moisture- and dirt-repellent.

The design of broadcast studios has been stabilized to a point where new studios contain relatively few major developments. While this speaks well for the designers of existing studios, the C.B.S. engineers were not entirely satisfied with certain features. They believed, for example, that the public would be better pleased if programs emanated from more "live" studios, acoustically, than in the past. So the new studios possess not only more liveness in their acoustic properties, but also controllable liveness. Also, the wall and ceiling surfaces are arranged so that there are no opposite surfaces parallel to each other, thus reducing undesired standing wave patterns. This fea-

The main facade of the studio building which is located directly across the street from the main C.B.S. building. The new facilities include two large studios, five small studios and one experimental studio

ture was first used in the studios of the C.B.S. station KNX which were described in the April 1938 issue of *Electronics*.

The engineers also believed that the work of the control engineer could be simplified by a more convenient arrangement of the equipment about him. So they redesigned the control console so that he could reach all controls, plugs, jacks, etc, without moving from his normal sitting position. Several changes were made to improve his

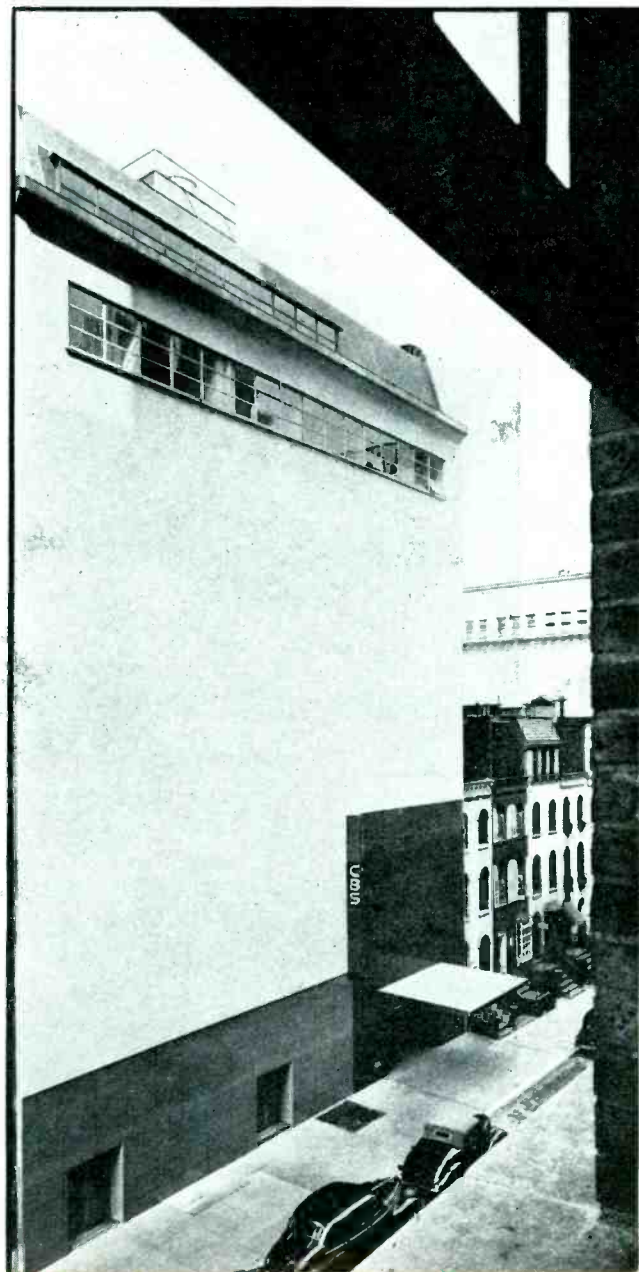

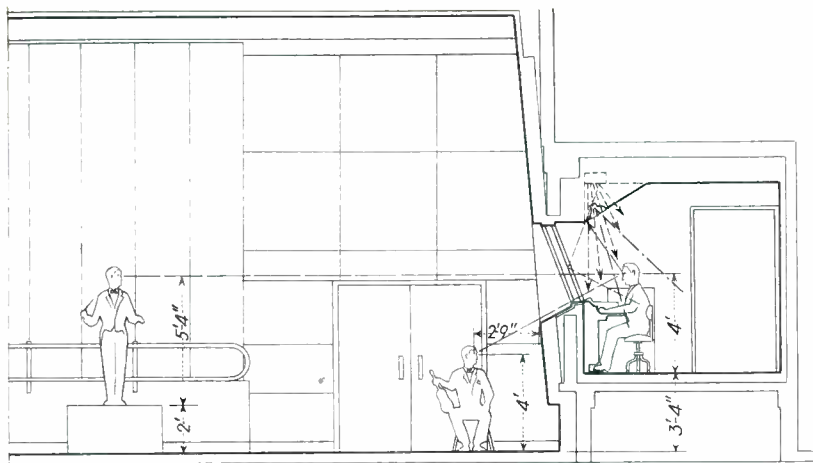

Studio and Control Room Section

This diagram was used in determining the positions of the essential elements of the studio such as the console, director's desk in the control room and the stage

vision of the performers in the studio proper. The glass in the window was set at an angle to remove reflections which would disturb the view. Pains were taken also to eliminate reflections by proper arrangements of the interior lights and equipment. Also, the control room was extended slightly into the studio and the window curved at one end to provide an extended view, as shown in the diagram. The photograph taken from the point where the eyes of the engineer would normally be located, shows how completely the operations in the studio can be seen from the engineer's position.

*Controlled Acoustic Characteristics*

The C.B.S. engineers endeavored in this new installation to provide acoustic liveness, and to control it, so that programs requiring different illusions in their locale could be put over with realism. Illustrations

of extreme cases are speakers or musical instruments in a large empty hall with hard walls and the same speakers or instruments in an open field. The first illusion requires pronounced reverberation, the second requires practically none. Also audiences accustomed to listening to symphony orchestras in large reverberant halls are apt to object to the dead quality of music broadcast from a sound-deadened studio.

In the acoustic design of the two large studios, two facts were used as starting points. One is that symphony music halls are built largely of wood and the other is that the tone of a violin depends entirely upon the nature of the wood and its construction. Thus, it would seem, wood in a broadcast studio may affect to a large extent the nature of the sounds broadcast. However, there are many reasons why studios cannot be constructed of wood, not the least of which is

the fire hazard. Nevertheless, in the new studios good effects have been achieved by the judicious application of wood in strategic portions of the walls.

To control the reverberation, large movable wooden panels, called Acoustivanes, are mounted on the walls. These panels are capable of rotation to expose sound absorbent material on the wall behind them. The panels and their relation to the wall area are shown in the accompanying photographs. To avoid any possible electrical interference from control mechanism of the Acoustivanes, they are remotely operated by a pneumatic drive. Thus, there is no electrical machinery which might be the source of interference. The control-room operator can adjust the position of the vanes by manipulating push buttons on the console. The angular position of each group with respect to the surface of the walls is indicated by a meter.

*New Design of the Console*

The control console represents progress, as previously stated, in that all controls, plugs, jacks, etc. are within easy reach of the control



Left, typical small studio. The window of the control room is set at an angle so that annoying reflections to the engineer's eyes are avoided

Below, the control engineer has an almost complete view of the activities in all parts of the studio. These photographs were made with the camera in the normal position of the engineer's eyes

Lower right, console with the patching plugs located on the arms of a U provide convenient operation for the control engineer

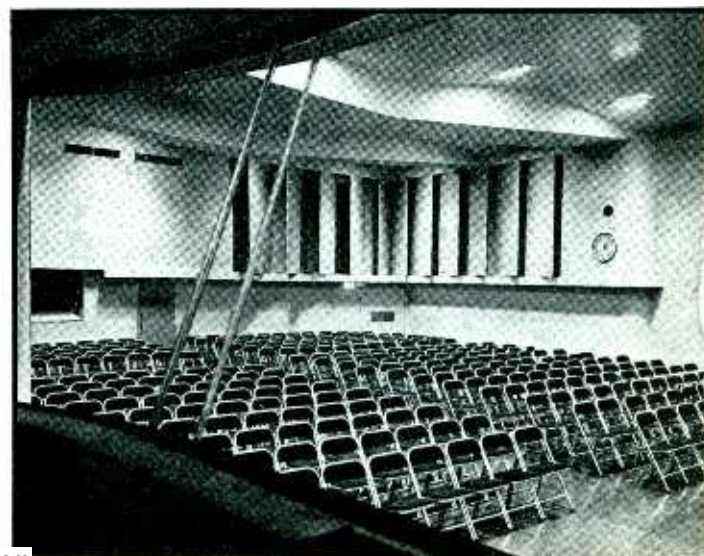

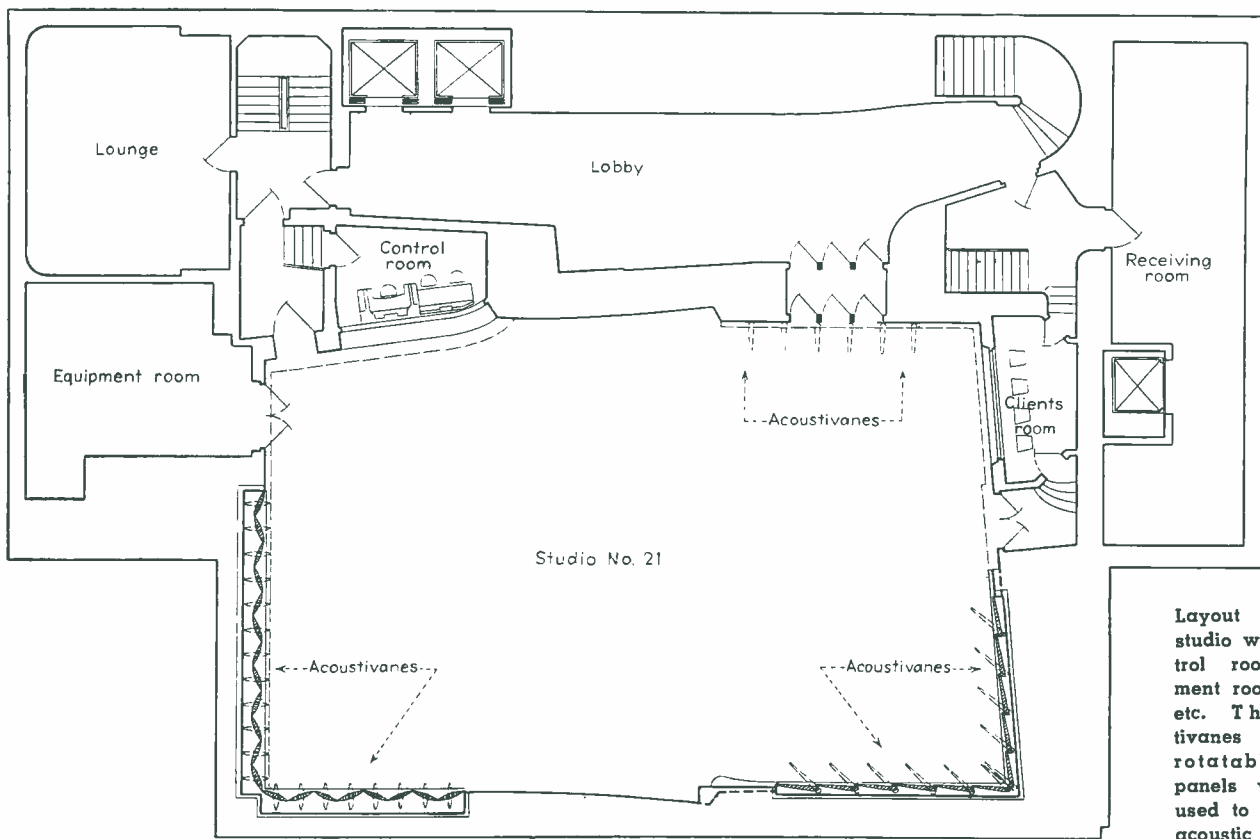

Layout of large studio with its control room, equipment room, lounge, etc. The Acoustivanes are large rotatable wood panels which are used to control the acoustic characteristics of the studio

engineer when he is seated in his normal position. All the switching and patching gear has been removed from the console. The layout of the console is in the form of a U with the engineer seated in the center. The eight-position mixing circuits, audio amplifiers and monitoring apparatus are directly in front of the engineer. The patching lines are located on each side of the U with the low level lines on one side and the high level lines for the monitoring and studio loudspeakers on the other side. The low level and high level lines are separated to avoid interference from crosstalk between the two groups. Rehearsal break and cueing facilities are also provided.

#### Monitoring Facilities

The volume indicator is the "vu" type adopted as standard by the major networks. The meter has the

following ballistic characteristics. When a single frequency voltage of such intensity to give a steady state reading of 0 vu is suddenly applied the pointer will overswing the 0 vu mark by about 1 per cent or 0.1 vu. The pointer will reach 99 per cent of its full deflection within 0.3 second after the sudden application of such a voltage. The sensitivity is uniform within 0.2 db from 25 to 16,000 cps. The motion of the pointer is easy to follow and the operators report that the strain involved with its use is considerably less than with the method previously used.

Aural monitoring is provided by a high fidelity loudspeaker unit suspended from the ceiling of the control room. The monitor speaker consists of two loudspeakers, a low frequency unit and a high frequency unit mounted coaxially as described in *Electronics* in April 1940. A

suitably sound treated enclosure is provided to give the proper low frequency response.

#### Audio Specifications

While the audio characteristics of the circuits are essentially the same as other recent C.B.S. installations, it has been possible to tighten up on certain specifications. The frequency characteristic from the microphones to the main control desk is flat within 1 db over the range from 40 to 10,000 cps and is independent of gain up to a point 10 db above the normal operating level (normal level is about 10 milliwatts). This compares with a 2 db variation over the same range in the KNX installation. The harmonic distortion is less than one-half per cent from 100 to 5,000 cps up to 100 milliwatts. The noise and hum level is 60 db below the operating level.

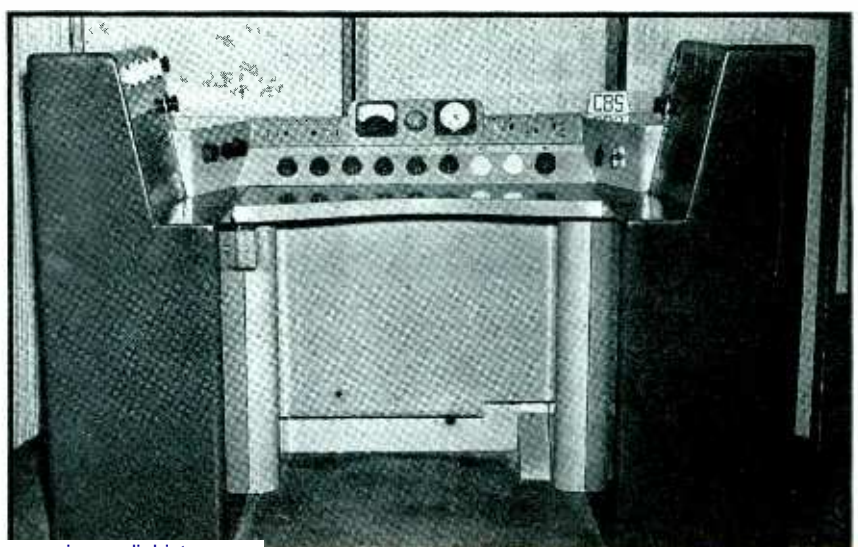

# Testing Ceramic

Before ceramic capacitors can be applied to cure the drift problem in u-h-f practice, their characteristics must be accurately measured. Here described is an unusually complete set-up for determining the temperature coefficient of these units by the substitution method

By E. T. SHERWOOD *Centralab Division of Globe-Union, Inc.*

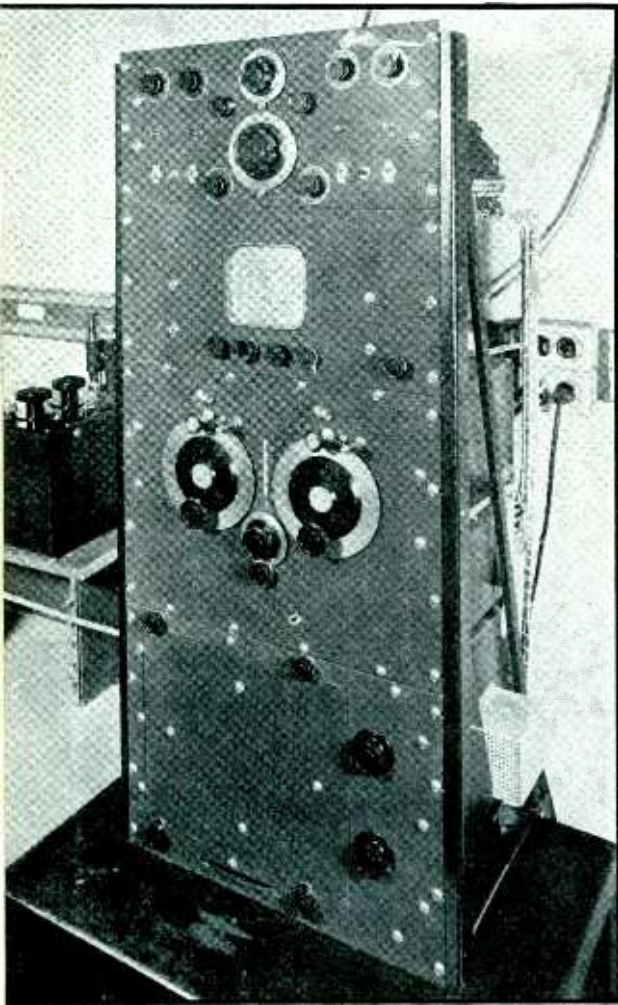

Fig. 1—The ceramic capacitor testing equipment, with door of work chamber closed

**W**ITH the advent of the ceramic capacitor and its widespread use in radio circuits during the last few years, has come the necessity for special testing equipment. Not only has it been necessary to make the routine tests commonly associated with capacitor manufacture with greater precision, but it has been necessary to develop special equipment and make special tests on the properties which make the ceramic capacitor valuable, for example, the temperature coefficient of capacitance and the power factor.

The first test considered is for capacitance. The unit of capacitance for small capacitors, the micro-microfarad, is one of the most difficult of the electrical units to measure in absolute magnitude. The National Bureau of Standards will certify the capacitance of a standard to  $\pm (0.5\mu\mu\text{f} + 0.05 \text{ per cent of the nominal value})$ . This means that the guaranteed accuracy of the

measuring standards (see Fig. 2), though they are the best available, may differ as much as  $1\mu\mu\text{f}$  in absolute value. On a  $100\mu\mu\text{f}$  unit,  $1\mu\mu\text{f}$  represents a difference of 1 per cent in the capacitance when measured with the two different pieces of equipment. Since tolerances on these capacitors are often as close as  $\pm 1$  per cent, it becomes necessary to correlate the measurements made on the two pieces of equipment. This correlation is necessary for a reason other than the possible difference in calibration of the standards. Primary standards of capacitance are invariably calibrated at 1000 cps and since these standards are not ideal capacitors, but have both residual inductance and resistance, they lead to erroneous readings when used at high radio frequencies. Inductance is particularly troublesome, since the inductance of the standard, combined with that of the connecting jig and leads, employed in different ways and at different frequencies, ultimately requires correlation between the two methods if perfect agreement is to be had. These points should be borne in mind at all times when making capacitance measurements on small ceramic capacitors.

#### Power Factor

The second measurement made on small capacitors to be considered is the power factor, or the loss factor. This factor is equal to the product of the frequency in radians, the equivalent series resistance in ohms and the capacitance in farads, ( $R\omega C$ ). The reciprocal of this factor is commonly referred to as the  $Q$ . The usual magnitude of the

power factor of ceramic capacitors is between 0.0002 and 0.001 at 1000 kc. This figure represents two very interesting facts. For practical purposes it represents the ratio of the active to the reactive power, or the watts loss to the voltamperes flowing through the unit and when multiplied by 100 gives the watts loss expressed as a percentage of the total power in the unit. When the power factor in per cent is divided by 0.0029, the result is the angle in minutes which the voltage vector deviates from that of an ideal capacitor where the voltage would lag 90 degrees behind the current. Hence, a ceramic capacitor would have a power loss of from 0.02 per cent to 0.1 per cent of the total volt-amperes and the voltage would lack from 0.7 minutes to 3.5 minutes of lagging the full 90 degrees behind the current as it would in an ideal capacitor. This is approximately the same magnitude of loss as that present at the low capacitance setting of precision type variable air capacitors employing ceramic insulation.

#### Temperature Coefficient

The primary purpose of this paper is to discuss the controlled temperature coefficient, the most important characteristic of the ceramic capacitor, and the equipment developed for its measurement. The radio and television engineer, the communication engineer, the amateur, and the designer of testing and special equipment have become conscious of the ever increasing demand for greater circuit stability. The development of television and frequency modulation using the ultra

# Capacitors

high frequencies has made desirable the use of a capacitor which has a zero or negative temperature coefficient. Most circuit components have a positive temperature coefficient, and by the use of a capacitor having the proper negative temperature coefficient, it is possible to reduce the temperature drift of the whole circuit to a negligible value. The usual range of temperature coefficient available is from +0.0002 to -0.00075  $\mu\mu\text{f}$  per  $\mu\mu\text{f}$  per degree C. These values of temperature coefficient have been found to be constant over the usual temperature ranges encountered in actual service.

Since there may be some doubt relative to the determination of the proper temperature coefficient and capacitance value to be used for compensating a circuit, it is desirable to discuss the relationships existing between frequency, capacitance and inductance; and to discuss the effects of changes in capacitance or inductance upon frequency. Let the following terminology and units apply to this discussion.

$f$  = frequency in cycles per second  
 $\Delta f$  = the drift in cycles per second due to a change in temperature

$L$  = the inductance in henries

$C$  = the total capacitance of the circuit in farads

$\Delta C$  = the apparent change in capacitance which would cause the drift in frequency, expressed in farads

$C_x$  = the capacitance value that is required for compensating purposes

$C_o$  = the circuit capacitance and any other portion of  $C$  that may not be included in  $C_x$

$t$  = the change in temperature in degrees centigrade

$\alpha$  = the temperature coefficient of  $C_x$  expressed in  $\mu\mu\text{f}$  per  $\mu\mu\text{f}$  per degree C.

Consider the familiar equation giving the frequency of oscillation of a circuit with zero damping.

$$f^2 = \frac{1}{4\pi^2 LC} \text{ or } C = \frac{1}{4\pi^2 L f^2} \quad (1)$$

Consider  $L$  as a constant and take the differential of  $C$  in (1) with respect to  $f$ :

$$dC = \frac{-df}{2\pi^2 L f^3} = -\frac{2C}{f} df \quad (2)$$

This may be written

$$\Delta C = -\frac{2C}{f} \Delta f \quad (3)$$

as long as  $\Delta C$  and  $\Delta f$  are small compared to  $C$  and  $f$ .

It should be remembered that the change in circuit values has been represented as an apparent change in capacitance, but it may actually be a change in the inductance, the total change having been referred to capacitance for compensation.

In order to compensate Equation (3) against drift, it is necessary to make

$$\alpha C_x = -\Delta C \quad (4)$$

The minus sign is required, since the effect of  $C_x$  is to compensate for the drift represented by  $\Delta C$  and hence must be equal to it in value and opposite in sign.

Since  $C = C_x + C_o$

$$\alpha = +\frac{2\Delta f}{ft} \times \frac{C_o + C_x}{C_x} \quad (5)$$

Example:  $\Delta f$  is found to be -5000 cps

$f$  is  $10^6$  cps

$t$  is  $20^\circ$  C. change

through which the

5000 cps drift occurred

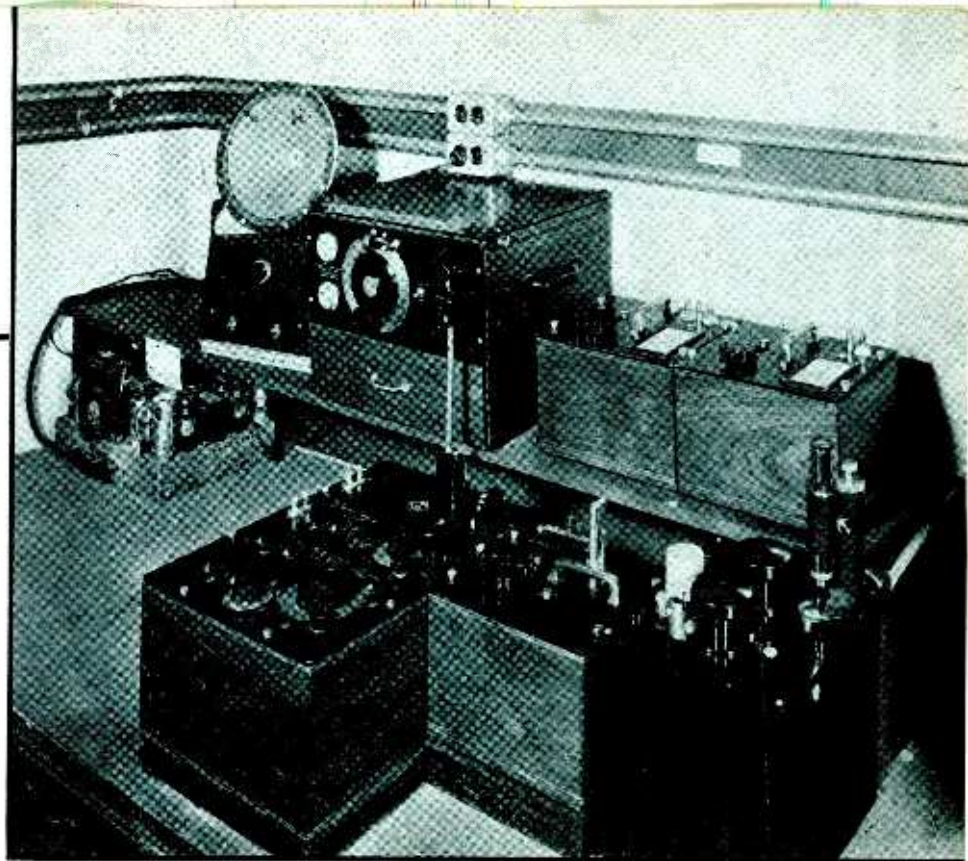

Fig. 2—Instruments used in measuring capacitance and power factor of ceramic capacitors. Microscope on the lower right hand capacitor is used for accurate dial readings

$C_o + C_x$  is 100  $\mu\mu\text{f}$   
 $C_x$  is 75  $\mu\mu\text{f}$

Therefore:

$$\alpha = \frac{-5000}{10^6 \times 20} \times \frac{100 \times 10^{-12}}{75 \times 10^{-12}} = -0.00033 \mu\mu\text{f per } \mu\mu\text{f per } ^\circ\text{C.}$$

The above computations give the value of temperature coefficient required to compensate a given circuit against changes in temperature. The equipment for measuring the temperature coefficient of ceramic capacitors should be capable of extreme flexibility, be able to accommodate a large volume of tests and be capable of rendering results having a high degree of accuracy. It was imperative that the equipment be so designed that units, with capacitances from 10  $\mu\mu\text{f}$  to 1000  $\mu\mu\text{f}$  having temperature coefficients from +0.0002 to -0.00075  $\mu\mu\text{f}$  per  $\mu\mu\text{f}$  per degree C. and varying greatly in size and shape could be tested without mechanical changes.

## Test Equipment

The desired accuracy of measurement of the temperature coefficient was set at  $\pm 25 (10^{-7}) [1 + 3(10^3)\alpha]$  in  $\mu\mu\text{f}/\mu\mu\text{f}/\text{degree C.}$  where  $\alpha$  is the nominal temperature coefficient of the unit. The reason for such a tolerance is quite apparent from two principal types of error to be expected. One is accuracy of setting

and reading capacitance dials, variations in residual capacitances and shifts in the oscillator, all of these being quite independent of size and temperature coefficient of capacitor under test. The other source of error caused by errors in reading the temperature of the unit during the test is proportional to the temperature coefficient of the unit being tested. The equipment shown on Fig. 3 was developed to meet the above requirements. A functional block diagram is shown in Fig. 4.

*Principle of Operation*

The principle of operation of this equipment is as follows: The capacitor to be tested is connected to the tank circuit of an oscillator. The oscillator frequency, or some multiple thereof, is adjusted to zero beat against the carrier of a standard broadcast station known to have an accurately maintained frequency. The temperature of the capacitor is raised or lowered as desired and the

frequency again brought to zero beat against the broadcast station by adding or removing capacitance in the tank circuit through the use of a calibrated variable air capacitor. Hence, the change in the capacitance of the calibrated capacitor is equal and opposite to the change in the capacitance of the capacitor under test for the particular temperature change involved.

While the principle is simple, the mechanical and electrical problems involved in the actual construction have been many. The greatest complication was caused by the desire to test several units at one time. It may be seen, from Figs. 3 and 4, that the equipment consists of five units, four of which are assembled on a standard relay rack and the fifth housed within a frame work which supports the relay rack. Unit No. 2, which is the work chamber, is made up of an insulated, rigid, aluminum box mounted behind a 14 inch standard relay rack panel. It contains heating and cooling means, a blower type fan for air circulation, thermostats for controlling the temperature, thermocouples for determining the temperature, a pivoted disc rotatable from the outside and designed to hold 13 units at one time, and a contact making jig for connecting into the oscillating circuit each of the 13 units as they are indexed into the test position.

The housing of the equipment consists of a 3/4-inch thick aluminum

lining surrounded on all sides by three layers of 1/2-inch thick insulating board with a sheet of aluminum foil between each layer. This inner lining and insulation is then pressed inside a sheet iron box, which is then fastened to a 3/8 inch x 14 inches x 19 inches relay rack panel. Entrance to the chamber is accomplished through a 11 inches x 12 1/2 inches door in this panel, the insulation behind it, and the inner box. This rigid, highly insulated box serves as a shield around the units under test and at the same time acts as a stabilizing factor on the temperature of the chamber. A maximum of 340 watts of heating power is available from a special 38-ohm heater, wound in the form of a squirrel cage about 4 inches in diameter and 2 1/2 inches long. This heater surrounds a blower type fan which draws air from the work space through an opening in the center of an aluminum baffle plate and forces it outward through the heater winding and cooling coil and back into the work space. In this way ample energy is provided to raise the temperature of the chamber 30 degrees C. above room temperature and for it to become stable in 30 minutes. Temperatures as high as 130 degrees C. may be attained easily.

Cooling of the chamber is effected by a U shaped, finned tube which is located around the heating unit and through which a precooled anti-freeze solution is pumped. This solution is maintained in a reservoir at a temperature below -20 degrees C. by the refrigerator unit shown at the bottom of Fig. 3 and shown as unit No. 1 in Fig. 4. Thus, the potential capacity for absorbing heat from the work chamber is built up during the heating and measuring time and stored for use in cooling the chamber when needed. The chamber can be cooled from 60 degrees C. to 30 degrees C. in 30 minutes.

The uniformity of temperature in the oven, especially in the actual work space, and the rapid transfer of heat during both the heating and the cooling cycles is assured by the use of the fan mentioned above plus suitable baffles. The constancy of the temperature is maintained by thermostats located in the heater end of the work chamber and against the metal liner. The tem-

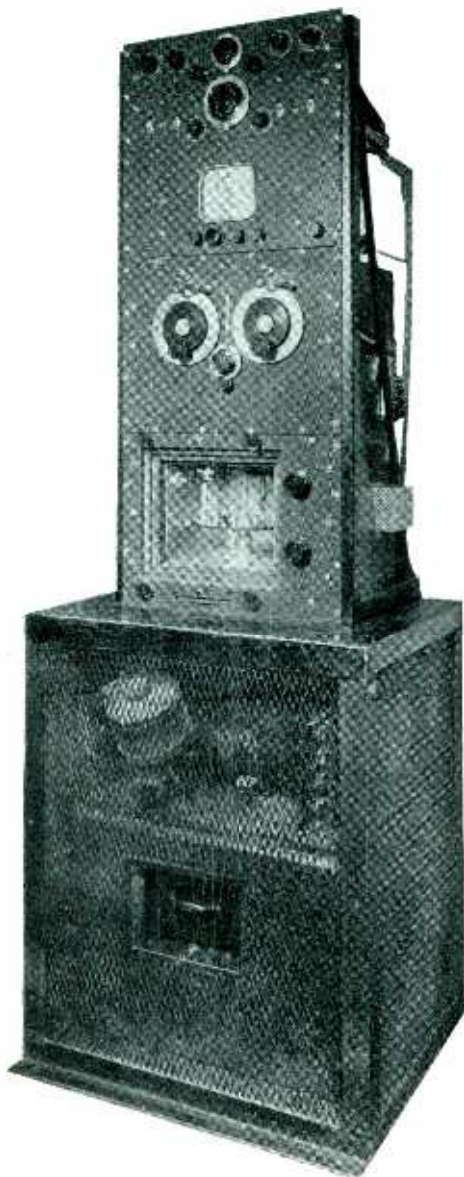
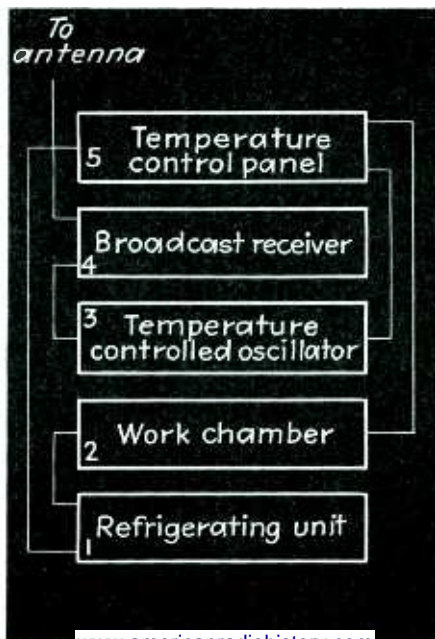

Fig. 3—Test equipment for measuring temperature coefficient and power factor of ceramic capacitors. The temperature-and-humidity-controlled chamber in which the unit is placed is shown

Fig. 4—Block diagram of temperature test equipment



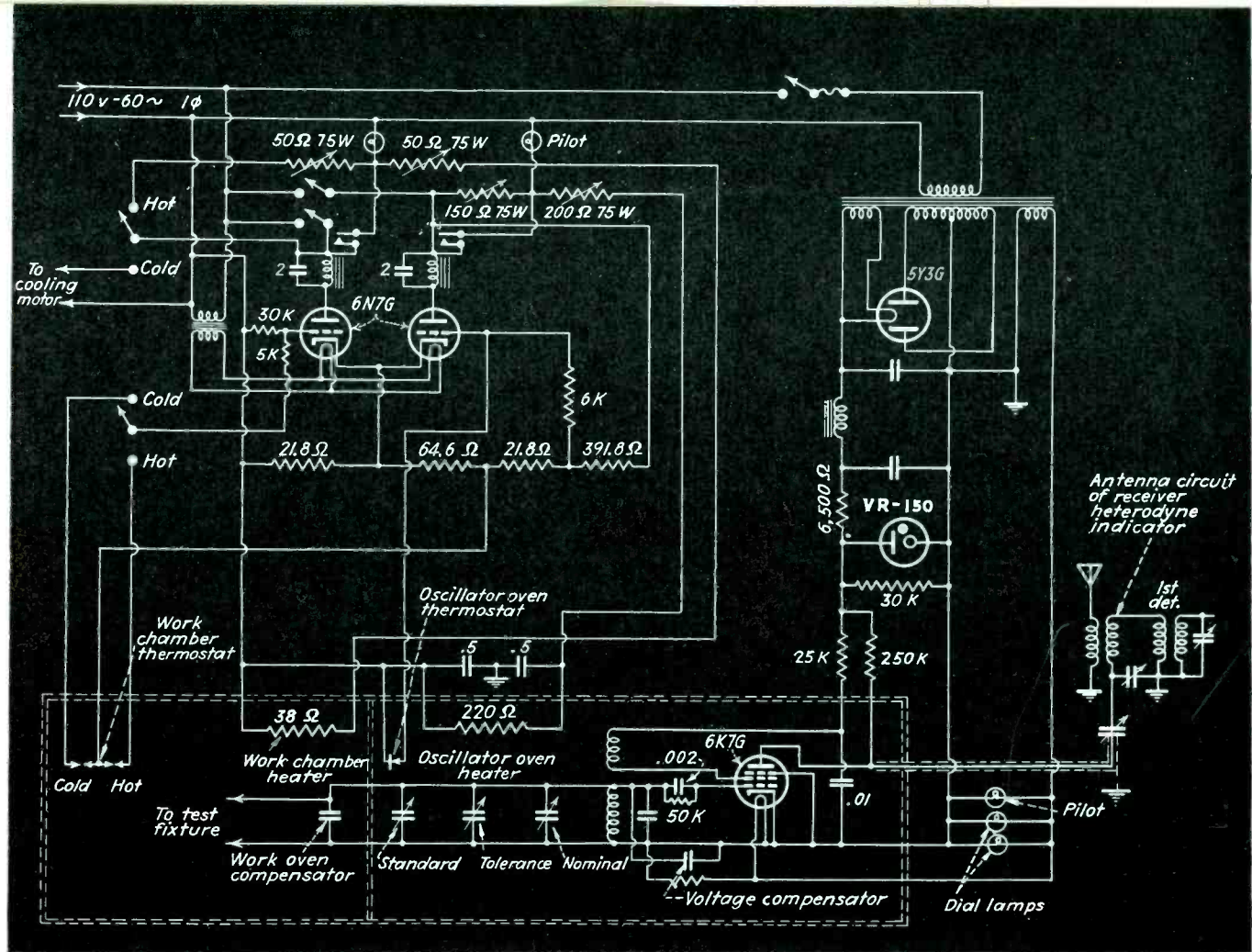

Fig. 5—Simplified circuit diagram of the test equipment. Both the capacitor under test and the oscillator are in temperature controlled chambers

perature is maintained constant to better than 0.1 degree C.

#### Control Circuits

The control circuits, a schematic diagram of which is shown in Fig. 5, for the work chamber heater and the oscillator oven heater are contained in unit No. 5. This is a very simple relay circuit operating directly from the 60-cycle 110-volt power lines. It consists of a twin triode tube with the thermostat in the work chamber connected to one triode grid and a relay in its plate circuit to control the heating rate of the work chamber. A mercury expansion thermostat in the oscillator oven is connected to the grid of the other triode section and the relay in its plate circuit controls the heaters in the oscillator oven. In both cases the heating rate is changed by a small increment. When the relay is on, a slight excess of heat is provided; when the relay is open, a slight deficiency of heat is provided. This differential in heating rates is kept as small as possible.

The reading of temperature of

the unit under test is accomplished by the use of two iron-constantan thermocouples connected in series to a temperature indicating potentiometer. These thermocouples are made from #28 wire. The hot junctions are  $\frac{1}{2}$  inch above the unit being tested and the cold junctions are brought outside the oven and maintained at 0 degrees C. by surrounding them with melting cracked ice, thereby reducing one source of error and eliminating the necessity of correcting for cold junction temperature. Thermocouples are much faster than a mercury thermometer, are easy to locate where desired, and are capable of indicating temperatures below -40 degrees C. Extremely low temperatures are attained by the use of dry ice. Humidity may be added to the work chamber and the relative value may be determined from the temperatures of wet and dry thermocouples since ample air circulation is provided in the chamber.

The rotating disc and bearing assembly used to carry the 13 units, which may be advanced one at a time into test position, is shown in

Fig. 6. The disc is bakelite with 13 equally spaced ceramic inserts around its outer edge. A stud is fastened into each insert and supports the outer end of the capacitor under test and also serves as a means of making contact to the stationary contact of the oscillator tank. The other ends are connected together and grounded to the inside metal box through a grounding contact to the center of the disc. All contacts are either pure silver or heavy silver plate. Extreme care  
(Continued on page 62)

Fig. 6—A group of ceramic capacitors mounted on the work disc ready for insertion in the work chamber

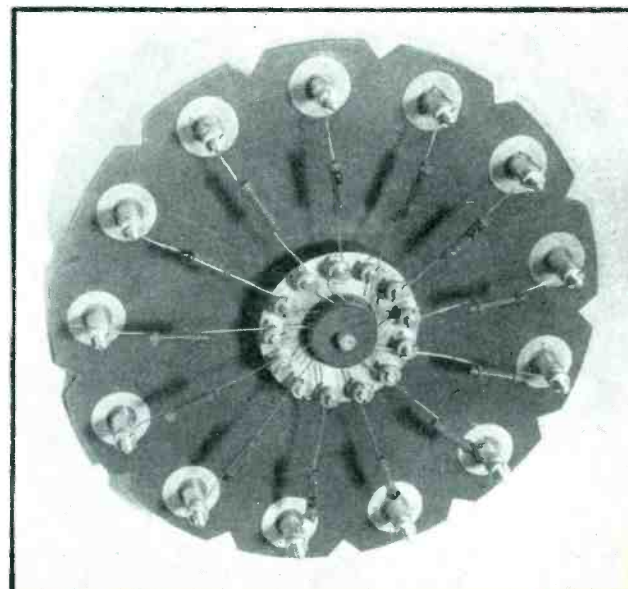

# Modulation Limits in F-M

By L. J. BLACK and H. J. SCOTT

Dept. of Electrical Engineering  
University of California

Since the generation of adjacent channel interference in f-m systems depends on the amplitude as well as the frequency of the modulating signal, such interference may be minimized by restricting the modulation in either of two ways. The authors show the permissible frequency deviations, for specified degrees of adjacent channel interference, at various audio frequencies, and in general make clear the notion of overmodulation as it applies to f-m systems

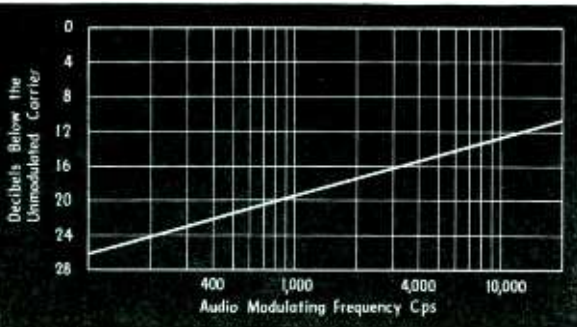

Fig. 1—The amplitude of the sideband at the edge of the band relative to that of the unmodulated carrier, for a frequency deviation of 75 kc. The higher the audio frequency, the stronger the sideband

IN an amplitude-modulated system, the degree of modulation is expressed as the percentage variation of the carrier amplitude. If this variation exceeds 100 per cent, distortion of the signal program is introduced. By properly limiting the frequency range of the modulating signal, the radiated frequencies can be kept within a specified band. On the other hand, in a frequency-modulated system, in order to confine the radiated frequencies to a specified band it is necessary to limit properly both the intensity and the frequency range of the modulating signal. This fundamental difference between a-m and f-m in the general problem of interference is evident from a comparison of the sidebands of the two systems. In an amplitude-modulated wave a modulating signal of 10,000 cps produces only two side frequencies, each differing from the carrier by 10,000 cps. This same signal used to frequency-modulate a carrier introduces an infinite number of side frequencies which differ from the carrier frequency by integral multiples of 10,000 cps. The magnitudes of the higher order side frequencies can be kept small by properly limiting the degree of modulation. A consideration of these factors for a frequency-modulated system is the subject of this paper.

The instantaneous frequency,  $\omega$ , of a frequency modulated wave is defined by the equation

$$\omega = \omega_c (1 + k \cos \omega_m t) \quad (1)$$

$$\omega_c = 2\pi f_c = \text{unmodulated carrier frequency in radians per sec.}$$

$$\omega_m = 2\pi f_m = \text{modulating signal frequency in radians per second.}$$

$k$  = a factor proportional to the intensity of the modulating signal and independent of the modulating frequency.

The expression for the instantaneous radio frequency voltage  $e$  is given by the expression

$$\begin{aligned} e &= E_c \sin \int \omega dt \\ &= E_c \sin \left( \omega_c t + \frac{k\omega_m}{\omega_m} \sin \omega_m t \right) \\ &= E_c \sin \left( \omega_c t + m \sin \omega_m t \right) \end{aligned} \quad (2)$$

where

$E_c$  = amplitude of the unmodulated carrier

$$m = \frac{k\omega_c}{\omega_m} = \text{modulation index}$$

The modulation index,  $m$ , is proportional to the intensity of the modulating signal  $k$  and inversely proportional to the frequency of modulation  $\omega_m$ . By expansion, Equation (2) can be expressed in the form

$$\begin{aligned} e &= E_c \left\{ J_0(m) \sin \omega_c t \text{ (carrier)} \right. \\ &\quad - J_1(m) \sin (\omega_c - \omega_m) t \\ &\quad + (-1)^n J_n(m) \sin (\omega_c - n\omega_m) t \\ &\quad \quad \quad \text{(lower side frequencies)} \\ &\quad + J_1(m) \sin (\omega_c + \omega_m) t \\ &\quad + J_n(m) \sin (\omega_c + n\omega_m) t \left. \right\} \\ &\quad \quad \quad \text{(upper side frequencies)} \end{aligned} \quad (3)$$

where

$J_n(m)$  = A Bessel function of the quantity  $m$  and of order  $n$ .

$$n = 0, 1, 2, 3, \dots$$

Equation (3) shows an infinite number of side frequencies extending in both directions from the carrier frequency. The ratio of the amplitude of the  $n$ th side frequency to the amplitude of the unmodulated carrier is  $J_n(m)$ . The amplitudes of the side frequencies extending beyond a specified frequency band will be small if the modulation index,  $m$ , has a small value. The value of  $m$  can be made as small as desired by limiting the intensity of the modulating signal.

The Federal Communications Commission has tentatively specified a "maximum bandwidth of emission of 200 kc". Limitations on the strength of signals on frequencies beyond this band width are not specified.

### A Practical Example

Previous treatments of frequency modulation have for the most part considered the permissible frequency deviation,  $kf_m$ , at maximum modulation to be equal to one-half the allowable bandwidth. Under these conditions, the magnitudes of the side frequencies beyond the specified band may be sufficient to cause serious interference in adjacent channels. As an illustration of this, a bandwidth of 150 kc and a modulating frequency of 15 kc will be assumed. If the deviation at maximum modulation is made equal to one-half the bandwidth, then

$$\begin{aligned} kf_m &= \Delta f_c \\ &= 75,000 \text{ cps.} \end{aligned}$$

and

$$m = \frac{kf_m}{f_m} = 5$$



where  $\Delta f_c =$  one-half the allowable bandwidth.

At the edge of the band,  $n$  is equal to 5. The ratio of the amplitude of this side frequency to that of the unmodulated carrier is 0.261 or -11.7 db. A signal of this magnitude may be sufficient to cause interference in an adjacent channel. For lower modulating frequencies Fig. 1 shows the magnitude of the side frequencies at the edge of a one-half bandwidth of 75 kc in db below the unmodulated carrier plotted as a function of the signal frequency.

The amplitude at the edge of the frequency band can be reduced to any desired level by adequately restricting the frequency deviation,  $k f_c$ , of the carrier. If the frequency band is limited by filters in the radio frequency stages, instead of by restricting the frequency deviation, distortion will be present in the reproduced signal.

Figure 2 is a family of curves showing the ratio

$$\frac{\text{maximum frequency deviation}}{\text{one-half bandwidth}}$$

plotted as a function of the ratio

$$\frac{\text{one-half bandwidth}}{\text{audio signal frequency}}$$

These curves are for the condition that the amplitude at the edge of the frequency band shall be a specified number of decibels below the unmodulated carrier. The levels are indicated on the curves. These values were obtained from cross plots of Bessel functions that are tabulated<sup>3</sup> for values of  $m$  up to 29. For values of  $m$  from 29 to 500 the

functions were computed from a relation given by Nicholson<sup>2</sup>. The curves, when plotted in this form, are quite universal and cover a range that should prove sufficient for any required calculations.

#### Use of Curves in Fig. 2

To illustrate the use of these curves, it will be assumed that the amplitude of frequencies outside a bandwidth of 150 kc ( $\Delta f_c = 75$  kc) must be at least 60 db below the level of the unmodulated carrier. At the edge of the band, the value of  $n$  is determined from the relation

$$n = \frac{\Delta f_c}{f_s}$$

and since

$$m = \frac{k f_c}{f_s}$$

then

$$\frac{m}{n} = \frac{k f_c}{\Delta f_c} = \frac{\text{frequency deviation}}{\text{one-half bandwidth}}$$

For an audio modulating signal of 7,500 cps, the value of  $n$  is equal to 10. Referring to the 60 db curve of Fig. 2; the maximum permissible frequency deviation is seen to be 0.48 times the one-half bandwidth or 36 kc. The maximum frequency deviation depends upon the frequency of the audio signal and its smallest value corresponds to the highest frequency of modulation. As a result of this, it might naturally be thought that the maximum deviation of the carrier frequency would be set by the highest audio frequency. This is not actually the case, however, because in the usual broadcast program the signal in-

tensities at the high frequency end are of relatively low level.

Examination of the relative intensity-frequency distribution in speech and music brings out the fact that the audio frequencies in the vicinity of 400 cps are the ones most likely to produce adjacent channel interference. This is illustrated in Fig. 3. Curves 1 and 2 show the relative peak pressures, expressed in db below the maximum, of conversational speech for men and women respectively. These two curves were drawn from the data of Dunn and White<sup>3</sup>. The relative distribution of peak power<sup>4</sup> for a 75 piece orchestra is shown by curve 3. Curve 4 is a plot of the ratio

$$\frac{\text{one-half bandwidth}}{\text{expressed in db relative to the ratio}}$$

at 400 cps. In determining this latter curve, a bandwidth of 150 kc has been assumed and the intensities outside of this band are limited to 60 db or more below the unmodulated carrier.

These curves indicate that if the permissible deviation at 400 cps is not exceeded, the modulation at the higher and lower audio frequencies will fall within the required limits, that is, the frequency deviation will always be less than the limit set by curve 4. At 400 cps the maximum carrier frequency deviation is 0.924 times the one-half bandwidth (Fig. 2). From these results, it can be concluded that if the peak audio intensities for speech or music in the vicinity of 400 cps produce a frequency deviation of less than 90

(Continued on page 65)

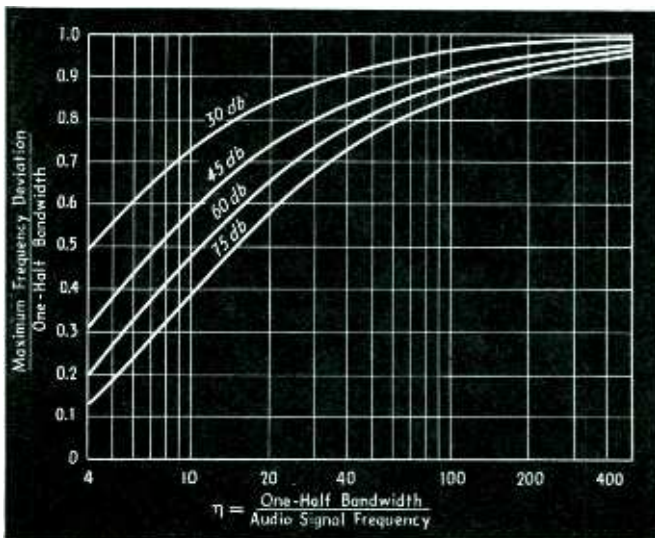
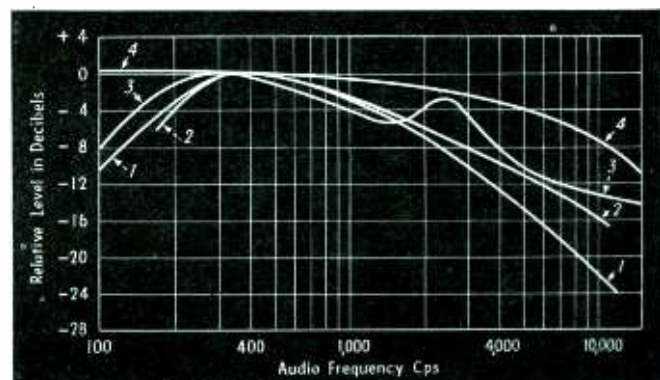

Fig. 2—Universal curves showing the permissible frequency deviation for various audio frequencies

Fig. 3—The relative energy of various program types as functions of frequency: 1, male speech; 2, female speech; 3, 75-piece orchestra; 4, permissible deviation relative to 400 cps



# "Tune 550—Highway Radio Ahead"



The transmitting equipment, shown above, includes a magnetic tape recorder and reproducer, which repeats a one-minute message

Approach at the western end of the George Washington Bridge. Radio-equipped motorists are urged to tune in for traffic instructions

**F**OR several weeks, motorists traveling on the west-to-east lanes of the George Washington Bridge, between New Jersey and the upper end of Manhattan Island, have noticed a sign advising them to tune their auto radios to 550 kc. Those who have done so have received a one-minute recorded broadcast from a local transmitter developed by William S. Halstead, New York communications engineer, installed with cooperation of the Port of New York Authority, operators of the bridge. The installation is of a temporary and experimental nature, but if surveys show that a sufficient number of motorists are using the transmissions, it may go into permanent service as a highway aid,

Low power transmitter on George Washington Bridge, New York, transmits instructions to motorists on frequency at edge of broadcast band. Signal confined by use of induction field only and by shielding effect of the bridge

The broadcasts, which are recorded on a magnetic tape device developed by S. K. Wolf and S. J. Begun, instruct the motorist concerning the proper lane to take for uptown, downtown and crosstown routes.

The transmitter is a conventional crystal-controlled outfit of four watts output power, which feeds a cable strung along the railing of the bridge for the entire distance of 3500 feet between the two towers. The cable is terminated in a 400 ohm-resistor to prevent standing waves and attendant radiation, hence only the induction field sur-

rounding the cable is effective. The signal strength in the immediate vicinity (within one-sixth wavelength) is sufficient to permit reception in cars in the adjacent lanes, but not beyond. The shielding effect of the bridge cables also aids in preventing possible interference with broadcast services. The signal quickly disappears as the motorist passes the end of the "wave-guide" cable. The message on the magnetic tape may be erased and replaced when necessary entirely by remote control, using an ordinary telephone connection.

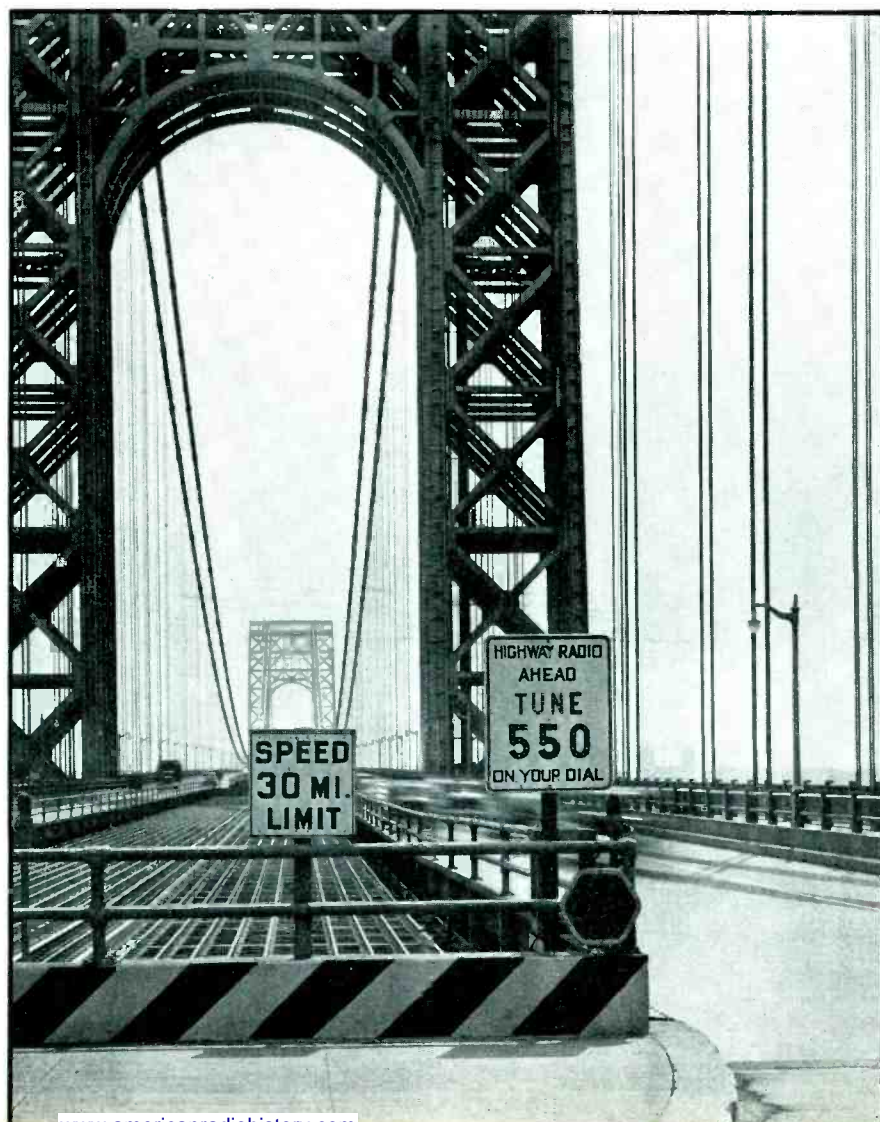

# Recent Improvements in Recording

New mechanical designs, a variety of useful gadgets, cutters which permit high-level wide-range recording without distortion, improved playback pickups and equalizers, have brought instantaneous recording in line with the trend toward higher fidelity.

By C. J. LEBEL

**D**URING the past year much attention has been focused on improving the quality of sound reproduction, due largely to the influence of frequency modulation. The broadcasters have begun a search for better microphones and speech input equipment, better program lines, improved monitoring methods and the like. During the same period there has been a pronounced development of improved equipment for instantaneous recording on acetate discs. New mechanical designs with some basic improvements and many useful gadgets, better cutters, improved playback facilities, all these have contributed to the recording technique now available to broadcast engineers. While these improvements are for the most part well known to, and widely employed by, recording studios, they have not received the attention they deserve in broadcasting circles. This article is intended to review some of the improvements offered by new equipment and to discuss problems in connection with its use.

## *The New Machines*

What do the new recording machines offer? Primarily they offer greater mechanical rigidity, in some cases approaching that of wax recorders, which are the standard of comparison. This rigidity means less vibration and greater permanence of adjustment. One important convenience offered by the new machines is greater ease in adjusting the cutting angle. In many cases changing the angle (which is often required by variation of stylus

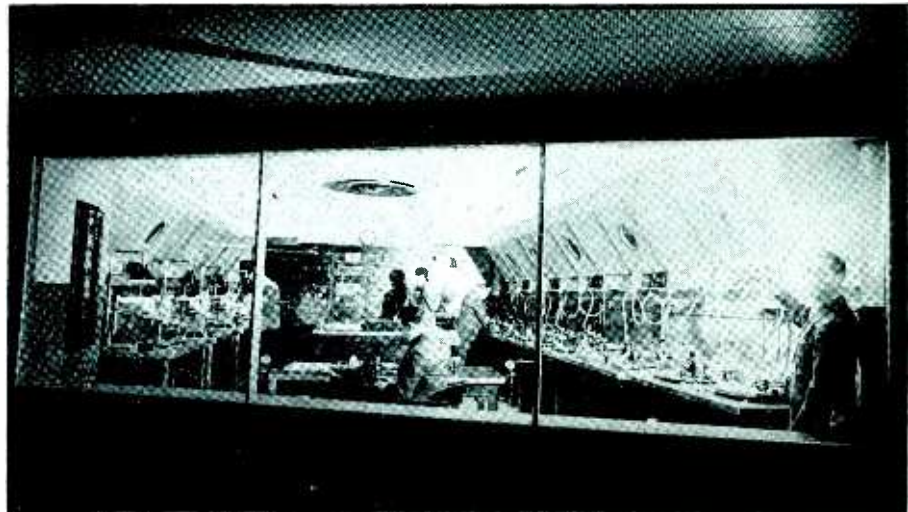

Recording has become a major branch of the broadcasting business, as witness the recording room of the N.B.C. Radio City Studios which contains six double-turntable acetate recorders (right) and four wax-acetate units

length) has been just sufficiently difficult so that it has not been done, to the detriment of results.

A convenience to some, almost a necessity to others, is the spiraling attachment available on many of the newer machines. Some customers insist on separation of numbers on transcriptions, many others would be attracted by it if offered. The spiral in to the finishing groove at the end adds a professional touch to artists' records. While the spiral can be produced freehand, it is very much easier to do so by mechanical means.

Most of the older machines lack time or diameter scales. In a busy studio use of a ruler and mental arithmetic is an invitation to trouble, so that the provision of a time scale is definitely worth while. In some cases provision for rapid change of feed pitch is also available. This is of value chiefly on 78 rpm records made for processing, when the record must be filled regardless of the duration of the selection.

A very worthwhile improvement has been added to a number of ma-

chines using rubber roller rim drive.

In the past there has been considerable trouble resulting from failure to release the pressure on the idler when the machine is not in use. The result is a flat roller and a serious wow. This possibility has been eliminated in some cases by manual interlock of motor switch and pressure lever. In other cases the interlock is electrical, that is, a magnet is used to release a spring under tension, thus allowing pressure to be applied to the idler. In either case there is no chance of that embarrassing discovery, a pair of flattened rollers just before an important job.

Lately there has been some vogue for vertical dampers or dash pots for suppressing vertical motion of the cutter. The use of the damper tends to prevent uneven coating or machine irregularities from producing serious cutter bounce. In professional use with properly surfaced, thick-base discs, and well adjusted trunnions, such dampers are not essential. On the other hand, records on very thin metal are apt to show more or less bounce regard-

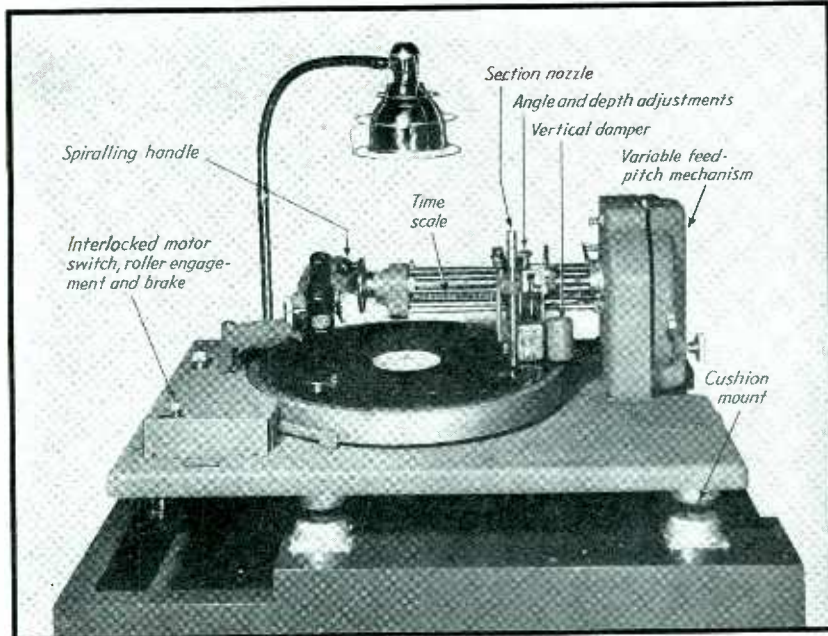

The RCA Model 73A machine is fitted with an interlocked motor switch and roller engagement, spiral gear, time scale, suction nozzle, a dash-pot for damping vertical motion, and variable feed pitch

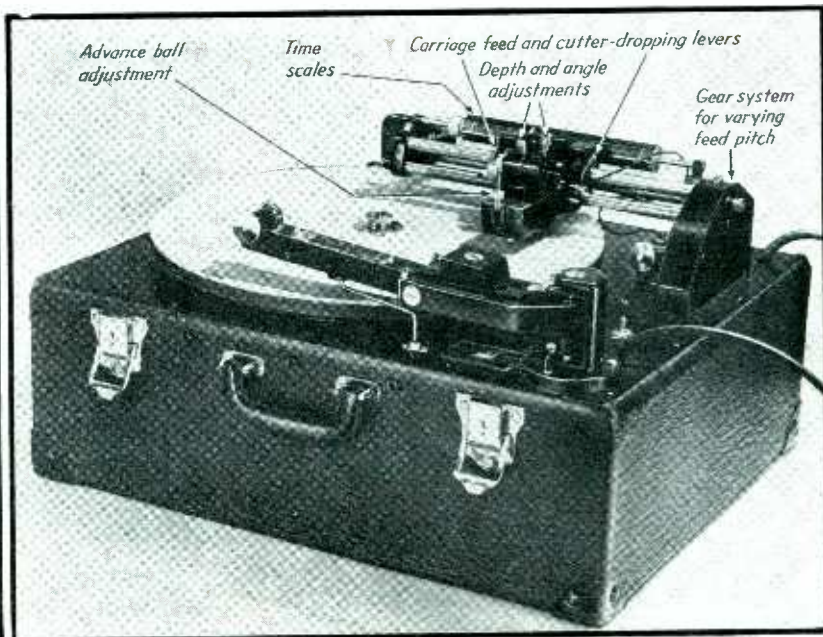

The Fairchild portable recorder uses a gear system for selecting various pitches and direction of cut, with a time scale to match each one, and an advance ball which controls the depth of cut continuously

less of machine adjustment. In such cases, the damper attachment may be of real help.

It is a good sign to see that more recorders are now equipped with microscopes and proper lighting, since the hand glass is rather uncertain when used in a hurry and the magnification is low. The new rigidly-supported high power corrected magnifiers and illuminators, with a battery in the base, have proven a popular and acceptable replacement for the microscope where installation space, cost, or weight are determining factors.

#### New Cutters

The last year has seen a rapid increase in popularity of the new and improved cutters. In the past the cutter has always been the neck in the quality bottle. Skillful equalization has been used to give wide frequency range, but it could not remove non-linear distortion. Thus it has been inadvisable to record at high amplitude, which in turn reduced the signal-to-noise ratio by 10 or 15 db.

The best cutters of today will record over 10 db more modulation (while retaining low distortion) than older cutters could put on at saturation (at high distortion). At the same time the frequency response curve has been made flat to 8000 or 9000 cps, depending on the make. Of course, not all makes are

equally good. In particular, the amount of distortion at normal operating level varies widely. The distortion variation with frequency is also of importance.

#### New Playback Systems

Of course, with wider recorded frequency range, wider playback range becomes a necessity. As a matter of fact, the playback should have a potentially wider range. This means, of course, both an improved pickup and improved equalization. In particular, provision for matching the orthacoustic curve must be made.

In most cases a "permanent" point pickup unit, which will operate at low pressure, is indicated. There is a current fallacy that the widest range is likely to be secured in a dynamic unit. This is not so. The characteristics depend (as is so often the case) not on the type of construction but on the skill of the designer. As a matter of fact, the widest range at the moment is probably offered in a recent magnetic unit with essentially flat response to 15,000 cps, and which tracks well at about 15 grams pressure.

It should be pointed out that the pressure required to give perfect tracking is invariably much greater than that required to keep the needle from jumping into the next groove. For example, a pickup device widely publicized several years ago, would

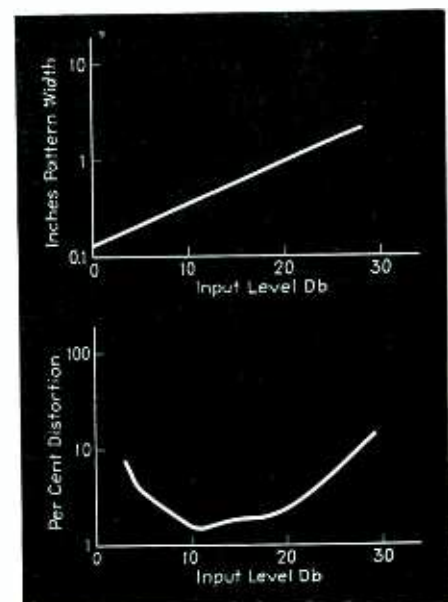

Comparison of cutter distortion measurements by the width of the optical pattern and by means of a distortion meter

not jump the groove at 3 or 4 grams pressure. To make it track properly it actually required 35 or 40 grams (at which the unit collapsed).

Lower needle pressure is not very vital in the broadcast station except in connection with two applications: masters should be played back at very low pressure, and audition records, which must be played many times, also should be played under reasonably good conditions. Certain coating formulas are much more fragile than others. Specifically,

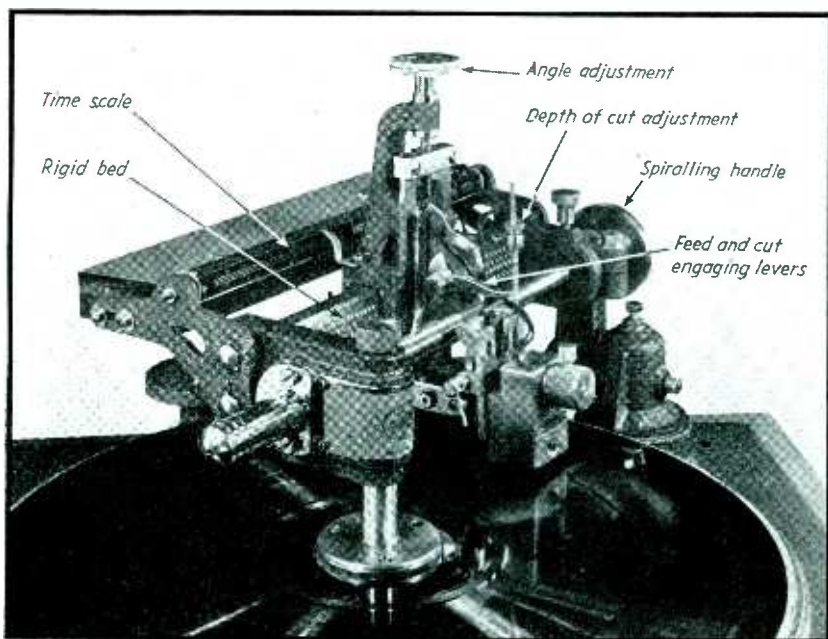

Presto's Model 8 has an exceptionally heavy bed, stylus adjustments for angle and depth of cut, a vertical damper, time scale, interlocked roller engagement and motor switch, and a spiralling handle

some may wear so badly that they must be played at only a few grams pressure to last over six or eight playings, while others may last for 200 playings at 1½ ounces pressure.

#### Chip Disposal

With nearly everyone recording from outside to in, there has been much interest in improved methods of getting the cut thread out of the way of the stylus. The old hand operated paint brush demanded too much attention.

Many of the larger studios have installed excellent suction systems. The first requirement for success is a good source of suction—which means a multistage centrifugal exhauster in most cases. Such a system requires considerable reserve vacuum. The second "must" is a well designed nozzle, hose and pipe, with no place for the thread to catch and jam. A helpful detail is a valve arrangement for seizing the thread at high vacuum, then continuing to pull it in at much reduced vacuum, with consequent reduced noise and improved monitoring.

Other organizations have tried the recently offered mechanical brushes, designed along new lines to wind the thread up in a coil about the center. These chip chasers have proven a very effective means, making suction quite unnecessary, and have proved just as reliable a method.

A final "must" is a wider range monitor speaker. Fortunately, good speakers have dropped greatly in price, and there is a wide variety to choose from. The lowest priced is a small special unit of conventional appearance and unconventional range; above it in price are the twin cones with the tweeter cone coaxial with the woofer. In general such units have no better high frequency characteristics than the first mentioned, but the low frequencies are handled much better. Finally, there are the rather expensive dual units using a multicellular tweeter. These seem to have even wider frequency range, and their response curve is remarkably smooth, that is, free from valleys and peaks. Non-linear distortion is distinctly less.

#### Testing the New Equipment

In connection with this new equipment the engineer has a number of things to consider, comment on which could be prefaced with the remark that just as the magician proves that the hand is faster than the eye, so a little adventure in high fidelity will soon convince the recordist that the ear complains faster than the eye viewing a meter dial.

The writer had an interesting experience recently. Artists' records

The Scully wax recorder, which has been adapted for use with acetate blanks, has hand- and power-operated spiralling gear, variable pitch, and other refinements

had been made in one studio, using one machine. In the course of a spring housecleaning the machine was replaced by another of the same type. The cutters shifted at the same time, of course. Very shortly afterwards, complaints began to come in from good customers. The music had a "hard", distorted sound. A number of records were checked. The effect was undoubtedly there. The distortion meter had a definite but not impressive story—1.25 per cent (at 400 cps) for the good cutter; 1.8 per cent for the bad one. The cutters were exchanged, customers were happy once more. The customers were of a type not notably discriminating as regards tone quality. The increase in distortion was less than 0.6 per cent, which is ordinarily considered negligible.

Perhaps the answer lies in the type of distortion produced. A paper by Massa showed some time ago that 1½ or 2 per cent harmonic distortion might be accompanied by crossmodulation with an intensity of 8 per cent. The ordinary single frequency test, of course, will not reveal that. The same explanation shows why cutter distortion at 5000 cps and above cannot be neglected. The second harmonic lies above the range of the average pickup, but most important crossmodulation tones usually lie very close to the fundamental in frequency and hence can be seriously offensive.

Another interesting case arose in attempting to determine the velocity-distortion curve of a cutter by use of the optical pattern. The engineer concerned applied 400 cps, increasing the level in 2 db steps.

(Continued on page 79)

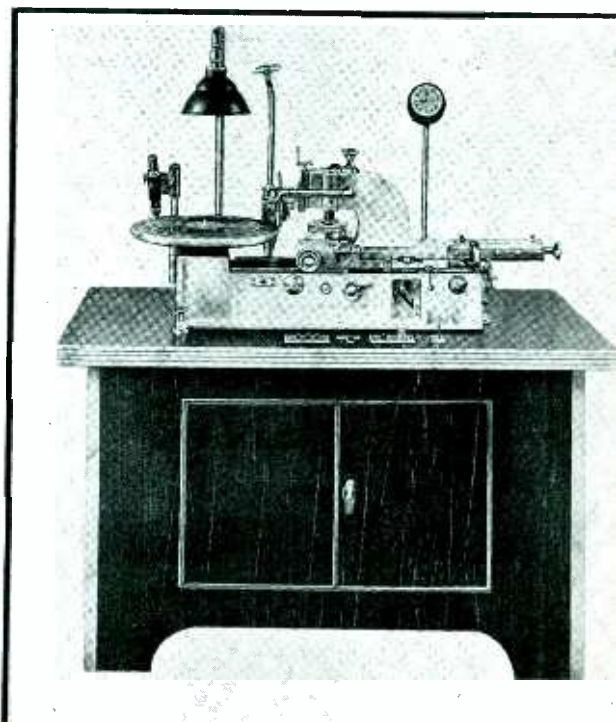

# OPERATION of a

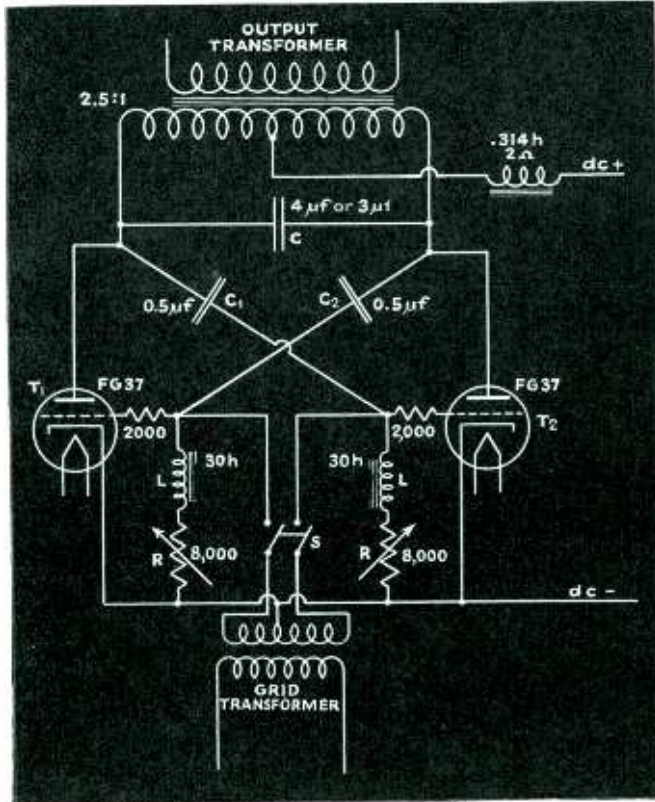

Fig. 1—Circuit diagram of the self-excited variable frequency inverter

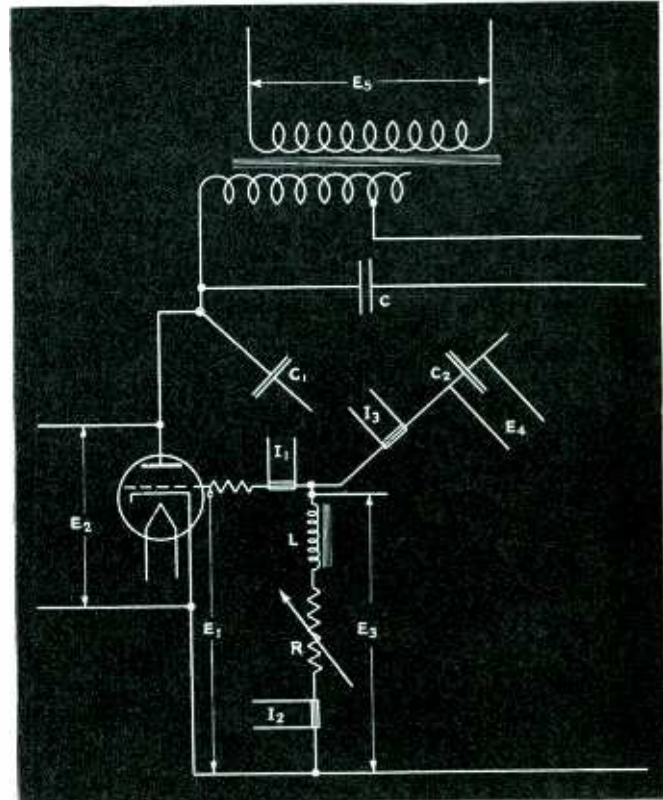

Fig. 2—The oscillograms of Fig. 3 were made with the oscillograph connected to the points indicated

**T**HE development of a new tool in industry often leads to new uses and applications. Inversion, which is the process of changing direct current to alternating current is the result of the development of the grid-controlled, gas-filled tube. Many inverter circuits have been devised, some of which have been put into actual service, while others still being studied and developed show promise of being of practical value. The particular circuit herein discussed has been published in several places, but as far as is known its characteristics have not before been given. Also certain additions to the circuit for ease in starting have been added.

The circuit, which is shown in Fig. 1, is a variation of the so-called separately excited parallel type inverter modified for self-excitation and variable frequency operation. Since the principle of operation of

this parallel type inverter circuit, its performance and its calculation have been rather completely covered in other places<sup>1, 2</sup> attention will here be given to variations in the circuit which provide for self-excitation and variable frequency operation. As is shown in Fig. 1, the grid of each tube is connected to a circuit consisting of a condenser, an inductance, and a variable resistance. The condenser is charged when the tube to whose anode it is connected is not conducting, since it is then in effect across the whole primary winding of the transformer less the voltage drop in the other tube. The condenser discharges through the *R-L* circuit and the tube to which it is connected, when this tube fires. The constants of the components of the *R-L-C* circuit to which each grid is connected are so chosen that the discharge is oscillatory, the frequency being adjustable by the value of the variable

resistance. That this discharge be of oscillatory nature is required for a sharp approach of the grid voltage to the zero line, which will give a definite firing time for each tube and by the fact that under certain conditions of operation such as low values of anode voltage, positive voltage is required for firing the tube.

In order better to visualize the conditions in this circuit during operation, oscillograph elements were connected at selected positions as shown in Fig. 2 and the oscillograms obtained are those of Fig. 3. Since these oscillograms were taken on a cathode ray oscillograph, it was not possible to line them up as well as could be desired, but vertical lines have been drawn, the interval between them representing the time tube 1 is firing. The next interval on either side is the time when tube 2 is firing and tube 1 is not conducting.

# SELF-EXCITED INVERTER

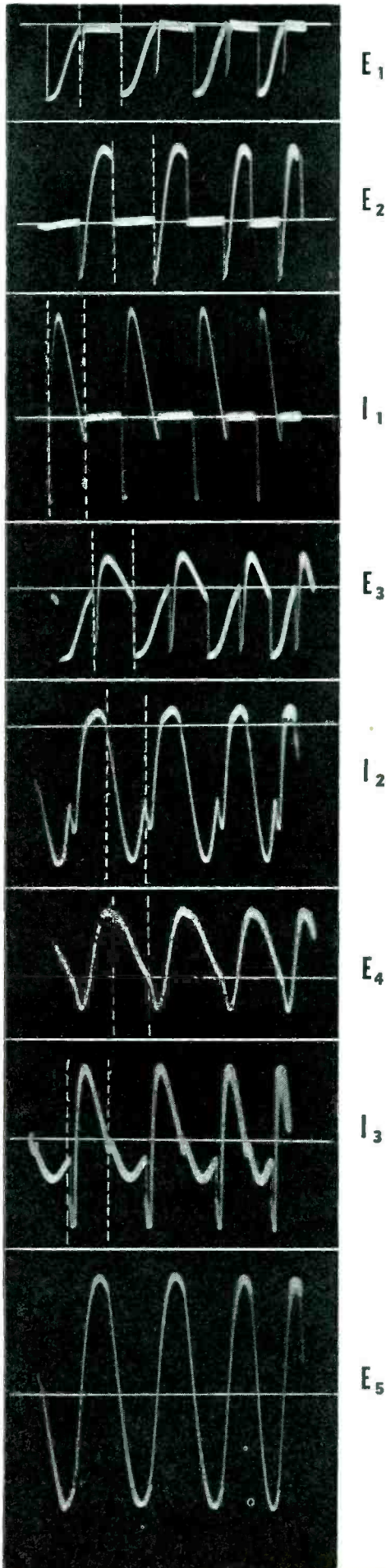

Results of a study of the characteristics of a typical self-excited inverter using grid-controlled gas tubes, which provides alternating current at varying frequencies from 40 to 110 cycles per second from a d-c source. Curves showing efficiency, frequency, regulation, and wave-form are given

The operation of this circuit, using the oscillograms as an aid to its better understanding, will be briefly discussed. Let it be assumed that the circuit is in operation and that tube 2 has just fired. Condenser  $C_2$ , which was charged to nearly the full potential of the transformer primary and with its positive terminal connected to the anode of tube 2, now starts to discharge through this tube and the associated  $R-L$  circuit at a rate determined by the constants of this circuit. As shown in oscillogram  $E_1$  of Fig. 3, this discharge holds the grid of  $T_1$  negative, thus preventing its firing although its anode voltage rapidly becomes positive after the negative commutating impulse from the commutating condenser which stopped it from further conduction. The anode voltage conditions are shown in oscillogram  $E_2$ . The currents in the grid-control circuit are shown in  $I_1$ ,  $I_2$  and  $I_3$ ; the voltage across the grid condenser by oscillogram  $E_4$ . As the discharge of condenser  $C_2$  progresses, the voltage applied to the grid of  $T_1$  decreases until the critical grid firing potential is reached and this tube fires. The commutating condenser  $C$  then discharges and stops

$T_2$  from further conduction. While all of the above action has been taking place, grid condenser  $C_1$  has been charging and it now repeats the performance of  $C_2$ , this time preventing the firing of  $T_2$  until the proper time is reached. As is seen, the recurrent action of the condenser discharges in the two grid circuits causes the tubes to fire alternately, thus giving an alternating current in the secondary of the transformer. The voltage output is shown in oscillogram  $E_5$ . The variable resistances in the grid circuits serve to control the frequency of operation of the tubes and thereby the frequency of the output current. They are adjusted together when the frequency is changed and in such relation to each other that the current taken by each tube is the same. This latter feature of operation is of considerable convenience since gas-filled arc tubes seldom have exactly the same characteristics and some type of balancing circuit must be used. The particular circuit used in these tests could be operated from 40 to 110 cycles per second.

There seems to be no particular reason why this circuit should start operating when direct current is ap-

Fig. 3 — Oscillograms showing the voltages across and currents through various portions of the circuit as indicated in Fig. 2

Fig. 4 — Operating efficiency, frequency, and input voltage, with output held constant

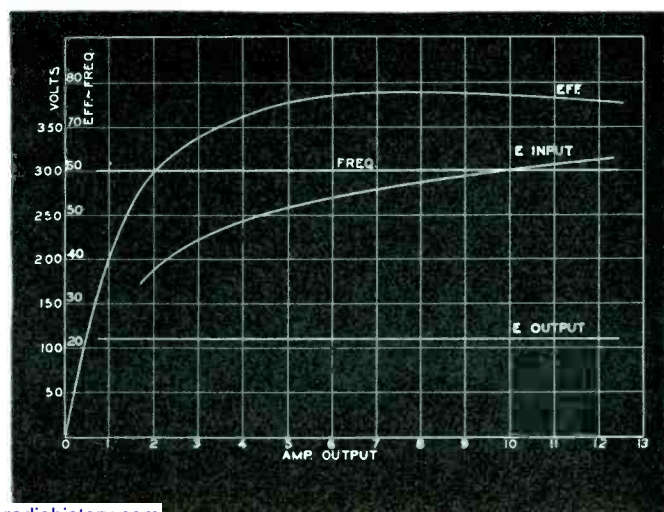

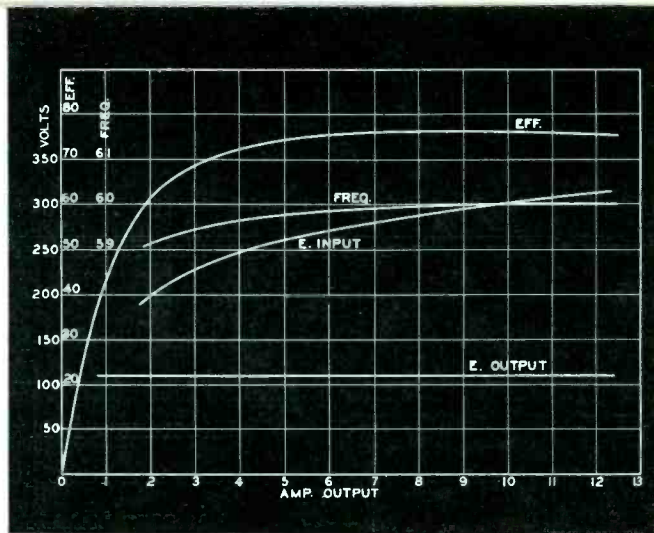
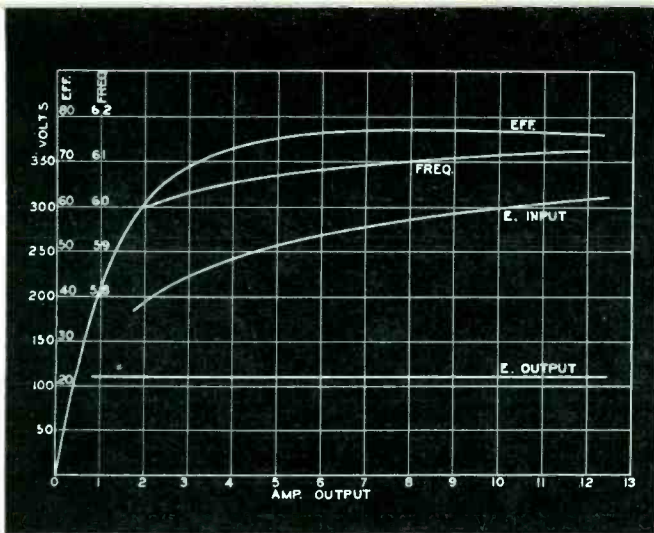

**A** Fig. 5—Curves showing the variations in frequency as the load is changed **B**

plied to the input. One of the difficulties as the circuit was first used was that it was at times very difficult to start. The addition of a grid transformer and switch *S*, as shown at the bottom of the diagram of Fig. 1, allowed the circuit to be started as a separately excited inverter. To use this method of starting the resistance *R* should be adjusted to give the inverter the same approximate frequency as the current supplied to the grids. The switch *S* is closed and low voltage direct current applied to the input. As soon as the inverter starts *S* is opened and the d-c voltage brought to the operating value.

There are several more or less interdependent variables involved in

the operation of this inverter. They are the voltage input, the voltage output, the load current, the output frequency and the efficiency. Several tests were made upon this circuit in order to determine their relations and the general characteristics under various conditions of operation. The results of these tests are shown in Figs. 4 through 7 inclusive and will be discussed but briefly since they are more or less self-evident. All of these tests were made with a non-inductive load.

The characteristics shown in Fig. 4 were obtained by varying the input voltage to hold the output voltage constant as the load was changed, and at the same time hold-

ing the frequency constant by the necessary adjustments to the grid-circuit resistors. As can be seen, a large variation of input voltage was necessary, as would be expected due to the poor regulation of this type of apparatus.

In order to determine the effect of changing load on the frequency, the tests whose results are shown in Fig. 5 were made. In both of these the output voltage was held constant as before with changing load. In the test of Fig. 5A the frequency was adjusted to 60 cps at light load and then not adjusted further, while in the test of Fig. 5B the frequency was adjusted to 60 cps at full-load and allowed to vary at

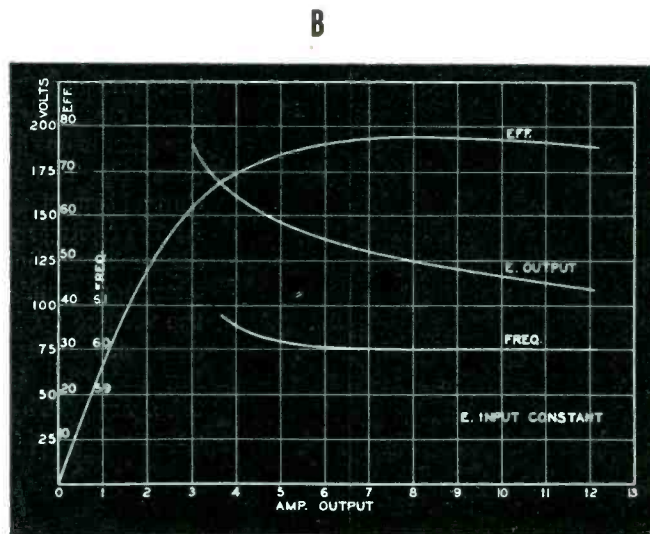
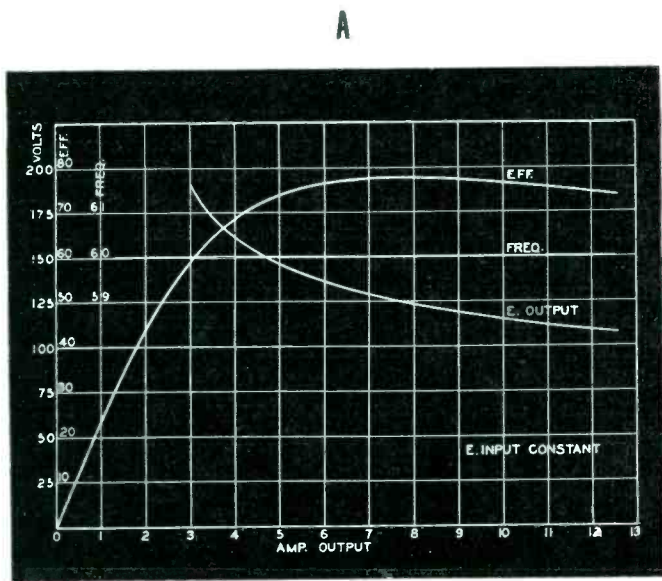

**A** Fig. 6—Curves showing characteristics when input voltage is held constant and (A) frequency held constant, (B) frequency set to 60 cps at full load and allowed to vary and (C) frequency set to 60 cps at light load and allowed to vary

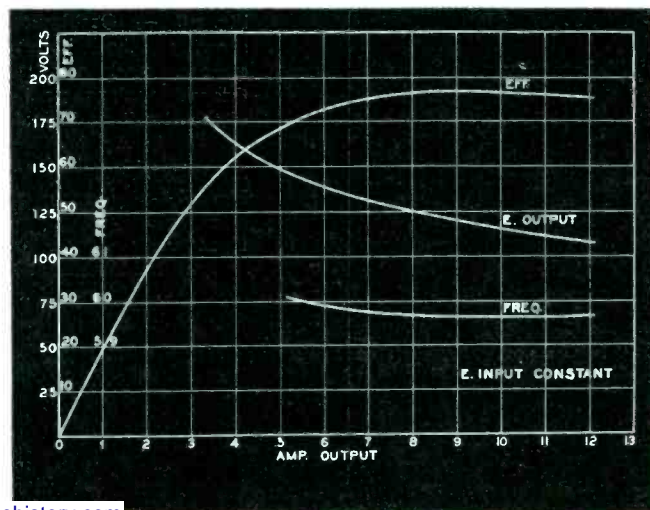

**C**



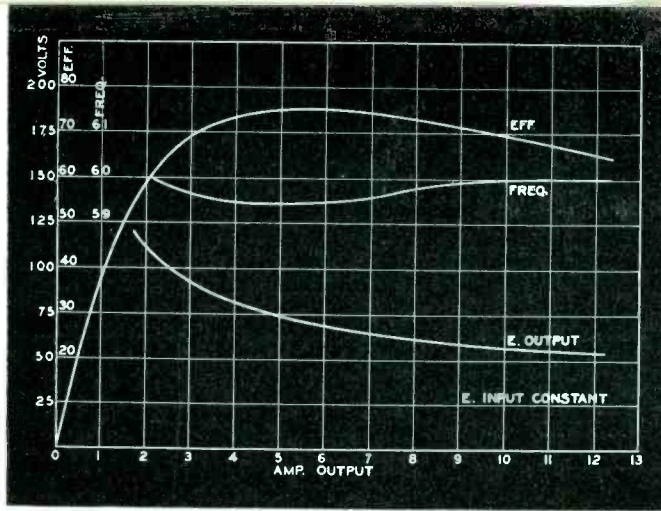

Fig. 7—Input voltage held constant with output voltage and frequency set to normal values at light load and both allowed to vary at will

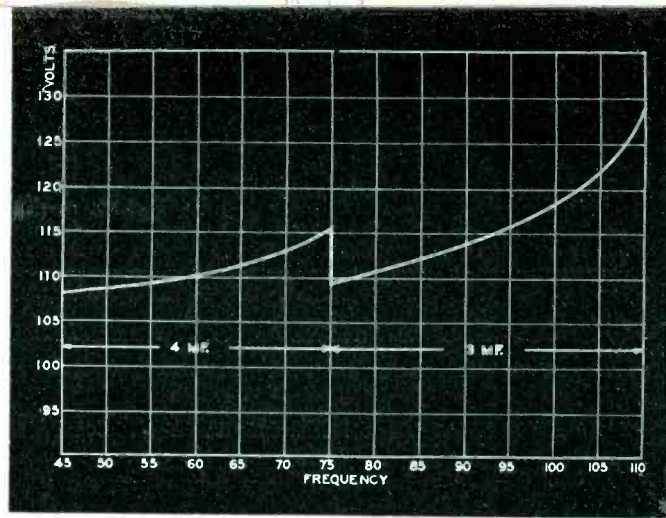
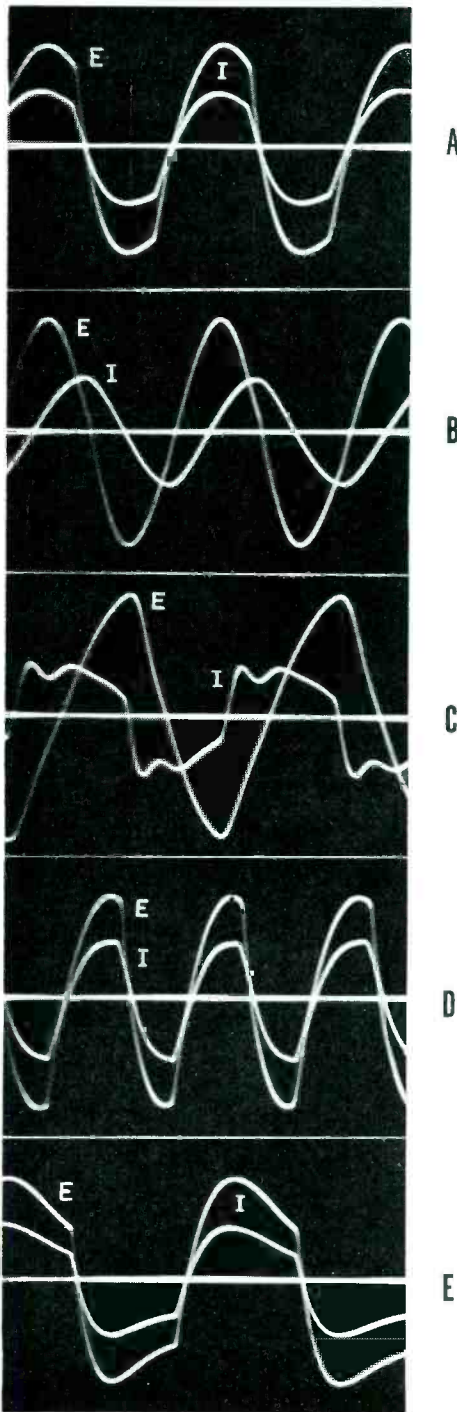

Fig. 8—Variation of the output voltage as the frequency changes with input and load constant. The discontinuity results from changed commutator capacitance



will. These tests indicate that with constant output voltage the frequency variations with varying load are small.

In the tests whose results are given in Fig. 6 the input voltage was held constant at the proper value to give normal output voltage at full-load. In A the frequency was held constant. In B the frequency was set at 60 cps at full-load, while in C the frequency was adjusted to normal at light load.

The results of Fig. 7 were obtained by holding the input voltage constant at the proper value to give normal output voltage at light load, and the frequency was adjusted to 60 cps at this same load and then allowed to vary as the load was changed.

The conditions of Fig. 8 were chosen to show how the voltage output changed as the frequency was changed. In this run the input voltage was held constant at the value which gave an output voltage of 110 when the load was adjusted to 1000 watts at 60 cps. As the frequency was varied both the load and the input voltage were held constant. In this type of circuit the higher the frequency the smaller may be the commutating capacitor and for best results it is often advisable to reduce the value of this circuit element as the frequency is increased. That this was done in this test is shown by the discontinuity in the curve.

The output wave forms from inverters are not in general noted for their sinusoidal characteristics and are affected considerably by the

character of the load into which they are feeding. The oscillograms of Fig. 9 show some characteristic output voltage and current waves under various conditions of loading and with various frequencies of operation. Oscillogram A was obtained with a non-inductive load of 950 watts at 110 volts, 60 cps. That of B represents the wave forms with an inductive load of 190 watts, 110 volts, 60 cps, 24 per cent power factor. A capacitive load of 116 watts, 110 volts, 60 cps at 13 per cent power factor was used for oscillogram C. Both D and E represent the conditions with non-inductive loads, the first with a load of 980 watts at 110 cps, the latter with a load of 830 watts at 43 cps.

This inverter was quite stable in its operation, in fact operating in much the same manner as a small alternator. With the sudden application of the addition to the load both the frequency and voltage would drop until the load was picked

(Continued on page 81)

Fig. 10—Oscillograms showing the result of the sudden application of load to the inverter. (A) Non-inductive load. (B) Inductive load. (C) Capacitive load

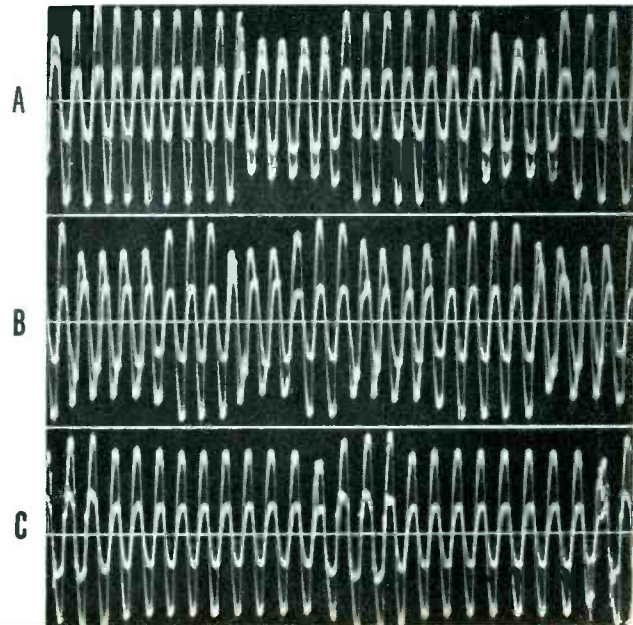

Fig. 9—Oscillograms of the voltage and current under various load conditions

# Simple Pulse Generating Circuits

Two methods of generating sharp impulses at power-line frequency in conventional tube circuits, useful in television, in grid-controlled gas-tube rectifier circuits, and for keying transmissions used in ionosphere measurements. Pulses of 100 volts amplitude and about 100 microseconds duration are obtained

By S. P. SASHOFF and W. K. ROBERTS *University of Florida*

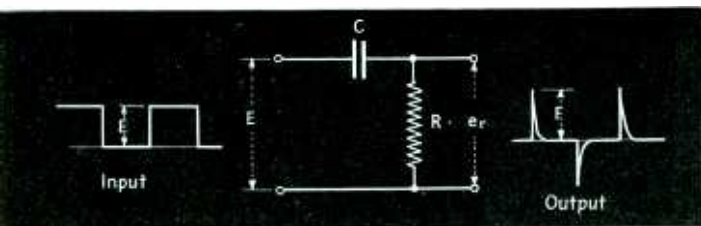

Fig. 1—Impulse-wave output derived from R-C circuit with square-wave input

**I**N commercial applications and in experimental and research work in the field of communications and electronics a need often arises for generators which can supply synchronizing or keying pulses at power line frequency. Pulses generated by these devices in order to be effective must in most cases have a sharp wave front and be of short duration.

Among the applications of such pulses are synchronization in television, control of grid-controlled gas-filled tubes, and radio transmissions for ionosphere research.

Television picture elements are sent and received in the proper order by keeping the horizontal and vertical sweep frequency generators in synchronism with each other and with a reference frequency. In the United States this reference frequency is the power line frequency of sixty cycles per second. Thus the sweep oscillators can be readily held in step with each other by being fed with pulses from the supply line. While in television broadcasting the system may be made independent of the power frequency, experimenters in this field find it necessary to synchronize with the power line if drift, streaking of the image and other undesirable effects are to be avoided.

Industrial applications of grid controlled gas filled tubes have mul-

tiplied very rapidly in recent years. Anyone familiar with these tubes, however, is aware of the fact that they are unstable unless controlled by pulses on the grid so selected in phase and magnitude that the breakdown characteristic curve is cut at a very sharp angle. The usual way of stabilizing them is to supply a sinusoidal wave of voltage to the grid of a magnitude which is several times the critical breakdown voltage value and thus keep them in step by "brute force". Sharply peaked control pulses of the same frequency would assure greater stability but have not been used because of the cost and complexity of available generators of such pulses.

In the field of ionosphere research the height of the ionized layers is measured by sending sharp radio pulses at vertical incidence and then recording the direct pulse and the echoes from the various layers. To accomplish this the output stage of the transmitter is biased beyond cutoff. The transmitter is then keyed by wiping off this bias for a very short period of time with a voltage from a pulse circuit. Because the time required for a pulse to reach the ionized layers and return to the ground is short, the pulses must be of one hundred to five hundred microseconds duration.

A number of very ingenious methods have been devised for generat-

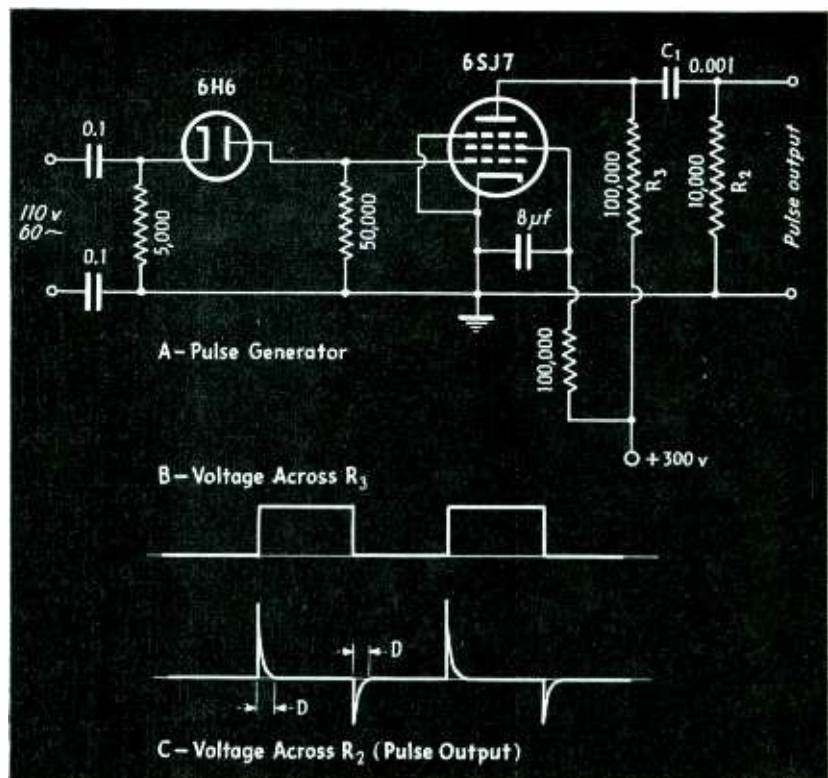

Fig. 2—Simple pulse generator using the square-wave principle. Two sets of output pulses, of somewhat unequal amplitude, are produced above and below the axis

ing sharp pulses of the type needed for the applications listed above<sup>1,2</sup>. Some of these devices use mechanical contacts and are driven by synchronous motors, others depend on spray jets, a third group utilizes multivibrator circuits, while by far the most popular method has been to generate a pulse across a resistor by current from a condenser discharging through a gas filled tube.

The two circuits described in this paper are of interest because of their simplicity. They use only high vacuum thermionic tubes and as a result are perfectly stable. The arrangements are only slightly affected by the aging of the component parts and are independent of line voltage variation. The effect of the line voltage variation is eliminated by driving the amplifier tubes to saturation or cut-off.

#### Square-Wave Circuit

The first circuit, shown in Fig. 2, operates on the principle that very simple transients are set up in a resistance-capacitance series network when a square wave of voltage is applied to its terminals. The wave shape of the charging-discharging current, the voltage across the condenser, and the voltage across the resistance of such a network are easily determined from the fundamental Kirchoff's law equation which states that the sum of the voltages around a closed path is equal to zero. Thus for the case when the

voltage across the network, Fig. 1, rises instantaneously from zero to its maximum value  $E$  and remains at this value for a time:

$$E - iR - \frac{1}{C} \int i dt = 0$$

the solution of which is

$$i = \frac{E}{R} \epsilon^{-\frac{t}{RC}}$$

and the voltage across the resistor is

$$e_r = E \epsilon^{-\frac{t}{RC}}$$

$$e_c = \frac{E}{\epsilon^{\frac{t}{RC}}}$$

It can be seen from the expression for  $e_r$  that the voltage across the resistor drops from its peak value  $E$  to nearly zero in a very short time if the capacitance  $C$  and the resistance  $R$  are made small. In a practical case, however, the time required for the decrease of the voltage to a negligible value is somewhat longer because the wave front of the voltage wave may not be exactly perpendicular to the zero axis and because a small amount of reactance is present in the leads.

The circuit is shown in Fig. 2. Line voltage is applied to a 6H6 tube double diode used as a half-wave rectifier. The rectified output across a 50,000-ohm resistor is then fed directly to the grid of a 6SJ7 pentode operating at zero bias. The polarity of the signal applied to the grid is such that it always drives

the grid in a negative direction. The 6SJ7 is thus very rapidly driven to cut-off and a voltage appears across its plate resistor  $R_3$  as shown on Fig. 2B. This voltage is then applied across resistance  $R_2$  in series with the condenser  $C_1$ . The resultant transient has already been described. The voltage wave across  $R_2$  is shown on Fig. 2C.

It should be noted that there are two peaks present and that one of these is sharper than the other. This is due to the fact that the output of the pentode is not an ideal square wave. This is not a disadvantage, however, since it offers a choice between two pulses, either one of which could be separated from the other by means of a diode or biased triode. The presence of the second pulse usually is of little importance since it occurs in a direction for which the controlled device may be made inoperative.

The generated pulses are approximately triangular in shape. For most applications this is quite satisfactory. If a flat-topped pulse is desired, however, it can be readily obtained by applying the voltage across  $R_2$  to the grid of a second amplifier in a positive direction and driving this tube to saturation.

The width of the desired pulse can be controlled by selecting appropriate values for  $C_1$  and  $R_2$ . Curves for the relative values of voltages obtained for different values of  $C_1$

(Continued on page 88)

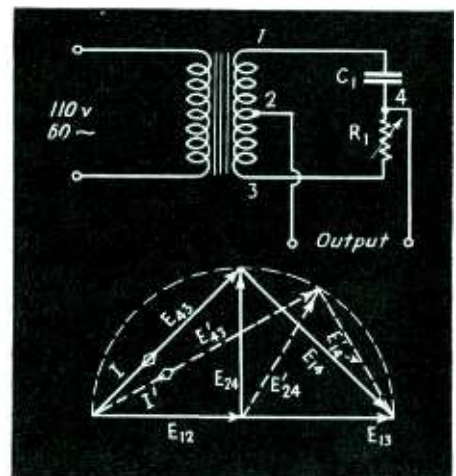
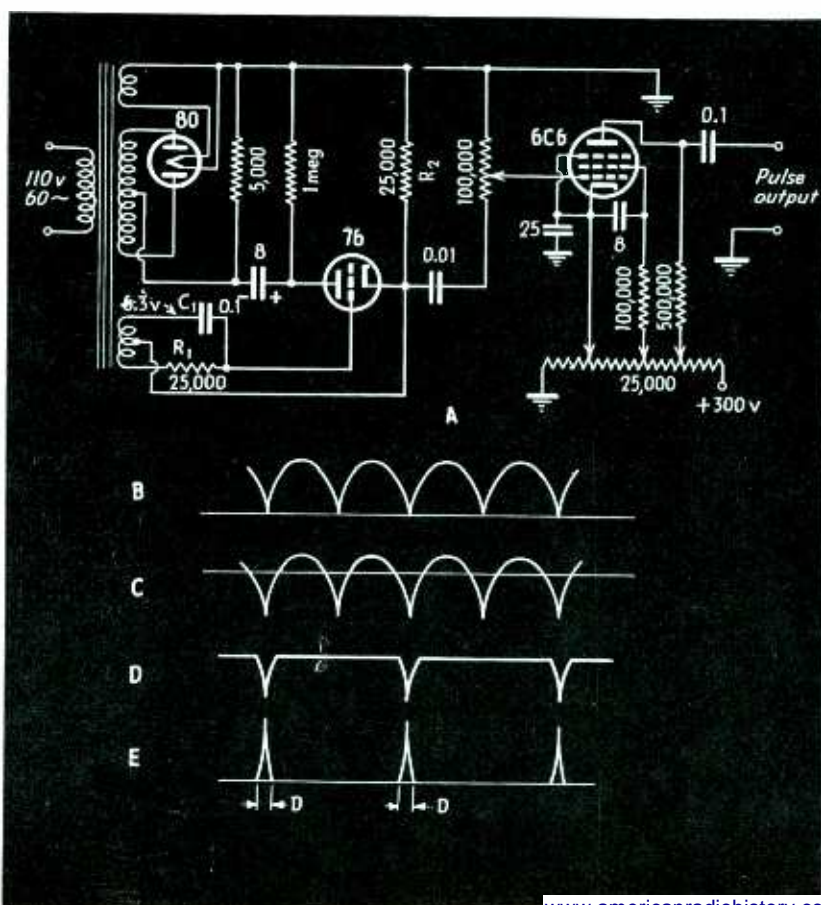

Fig. 4—(Above) Typical constant-output-voltage phase-shifting circuit and its vector diagram, useful for adjusting the position of the pulses over the range from 15 to 165 electrical degrees

Fig. 3—(Left) Pulse generator using the "V" portion of a full-wave rectified wave

# New Books

## Electrodynamics

By LEIGH PAGE AND NORMAN ILSLEY ADAMS, *Physics Department, Yale University. D. Van Nostrand Co. 506 pages. Illustrated. Price, \$6.50.*

THE AUTHORS ARE WELL KNOWN for their previous texts on mathematical and theoretical physics, "Introduction to Theoretical Physics" and "Principles of Electricity," and their third book shows much the same point of view and general method of treatment as appears in their earlier works. The present volume is designed as an advanced text in the theoretical aspects of electrodynamics and is decidedly mathematical in nature, since it makes extensive use of vector analysis, dyadics, tensors, and similar mathematical tools.

As indicated by the chapter headings, the subjects treated are: three-dimensional vector analysis, principle of relativity, the electromagnetic field, elementary charge and force equations, material media, energy stress momentum and wave motion, radiation and radiating systems, electromagnetic theory of light, four-dimensional vector analysis, and general dynamical methods. Electrostatics and electromagnetics are not treated in great detail.

The text will be found useful to research engineers and advanced students in theoretical physics or electricity; it is not intended for those who may be looking for sugar-coated knowledge.—B.D.

## Service by Signal Tracing

By JOHN F. RIDER. *Published by John F. Rider, 404 Fourth Ave., New York, 1939, 360 pages. Price \$2.00.*

## The Oscillator at Work

By JOHN F. RIDER. *Published by John F. Rider, 404 Fourth Ave., New York, 1940, 243 pages. Price \$1.50.*

## An Introduction to Frequency Modulation

By JOHN F. RIDER. *Published by John F. Rider, 404 Fourth Ave., New York, 1940, 136 pages. Price \$1.00.*

THESE THREE BOOKS ARE INTENDED to help the radio service man increase his efficiency and his earning power. Each of them sticks very close to fundamentals in the explanation of circuits and new technique. The first book explains the method of servicing radio sets and allied equipment by injecting a signal into the set at the antenna lead and then determining the nature of that signal as it progresses along its path

through the receiver. The defect in the set is then localized after definite knowledge is obtained of where the signal is no longer normally passed through the various circuits. By proper interpretation of what happens to the signal, the nature of the defect may be determined.

The second book, "The Oscillator at Work", is devoted to a description of the various types of oscillators in current use and also those whose capabilities have not as yet been fully utilized. 159 of the 243 pages are devoted to a description of the fundamental oscillator circuits and the problems encountered in their use. The remainder describes the methods of servicing the oscillators in various types of service, such as those in test oscillators and receivers. An appendix is included which describes methods of testing receivers as standardized by the I.R.E. An extensive bibliography of articles appearing in periodicals covering this subject matter is provided.

"Frequency Modulation" serves to introduce the serviceman to that new branch of the radio art. The fundamentals of frequency modulation and methods of servicing f-m receivers are explained from the point of view of the serviceman. A bibliography of f-m articles is included. This book will undoubtedly be of value to those service-

• • •

## NEW CODE SCHOOL



Students learning radio code at the new Maritime Training School operated at Gallup's Island, Boston Harbor, by the Coast Guard with funds provided by the Maritime Commission. 110 students between the ages of 18 and 23 are now enrolled

men who want to be ready to service f-m receivers when the demand for such work develops. The three books are written in a clear style which strikes a balance between being so elementary that the reader soon loses interest and being too technical.—c.w.

## Mathematical Methods in Engineering

By THEODORE V. KARMAN and MAURICE A. BIOT. *1940. McGraw-Hill Book Co. 505 pages. Price, \$4.00.*

## Mathematics Applied to Electrical Engineering

By A. G. WARREN and ALEXANDER RUSSELL. *D. Van Nostrand Co. 1940. 384 pages. Price, \$4.50.*

OBITUARY SERVICES CAN probably be read for the "rule of thumb" or the "handbook" engineer, for the engineer of to-day, and especially the research engineer, must have a good grasp of analytical methods—and that means, principally, mathematics. In former days a smattering of knowledge of the differential and integral calculus was considered adequate training, but recognition has been given to the need for more advanced and rigorous solutions to problems in engineering and physics. Collegiate courses in advanced mathematics have been organized and texts have been prepared for such courses. Two such texts are listed above.

Both books cover essentially the same general type of material, although there is little duplication and the styles of the two are quite different. Although both texts presuppose a familiarity with the differential and integral calculus, these subjects are treated to some extent. The scope of the texts may be better indicated by recalling that both deal with ordinary and partial differential equations, Bessel functions, Fourier series, complex variable, and operational methods based on the work of Heaviside. Numerous examples of the application of mathematical analytical methods to engineering and physics are given, and examples in mechanics, dynamics, acoustics and electrical engineering are included.

Both texts are direct and lucid, although of course the student of such works will not expect to find sugar coating liberally applied. The work of Karman and Biot is perhaps the more general of the two; at least the illustrative examples are drawn from a wider range of subjects. On the other hand the Warren-Russell book develops more completely those branches of mathematics which have been found especially useful in electrical engineering, and the illustrative problems are drawn primarily from this field. Both are well done, and can be recommended to the research engineer, the graduate student or mature undergraduate.—B.D.

(Continued on page 90)

# PERFECTLY CLEAR

CINCH DIAL LIGHT SOCKETS  
ASSURE MECHANICAL AND  
ELECTRICAL PERFECTION!

Radio engineers, technicians . . . and those who know—by use—are many . . . make it "perfectly clear" that for dial light socket dependability, *certain performance*, their choice is "CINCH".

Only the best materials and painstaking workmanship can produce these carefully designed parts; all metal parts are plated, and all assemblies are inspected and tested. Supplied in the plug and button type, which simply snaps into place, or with many different types of attaching brackets for both the bayonet and screw type designs. For your specific need there is a wide variety to choose from . . . each recommended by long, *satisfactory* use.

*"Cinch" and Oak Radio Sockets are licensed under H. H. Eby Socket Patents.*

**CINCH MANUFACTURING CORPORATION**  
2335 W. VAN BUREN STREET  
CHICAGO, ILL.  
SUBSIDIARY: UNITED-CARR FASTENER CORP., CAMBRIDGE, MASS.



# TUBES AT WORK

This month, the tube applications include a new circuit for testing relays, an electronic telemetering system which operates on direct current, and a new technique of making X-ray exposures

## An Electronic Relay Tester

By S. BAGNO

Kurman Electric Company

IN THE MECHANICAL LIFE testing of a-c relays, the problem arose of providing a life tester whose life exceeded the life of the relay. Formerly when the relay art was such that several hundred thousand operations were considered satisfactory for most uses, an ordinary mechanical contactor driven by a motor served the purpose satisfactorily. But with the introduction of new contact alloys, new spring alloys and more stable insulating materials the life of competitive relays of modern design has increased enormously and the problem of a satisfactory interruptor circuit that did not require continual servicing during prolonged tests and still provided enough power for a bank of relays became serious.

In order to meet this problem a new type of electronic test circuit was developed. The test unit, instead of having a life limit in the millions of cycles, was found to have a useful life without servicing exceeding many thousand hours. The limitations normally imposed on a test device of this type such as the speed of interruptions, the chatter of the interrupter contact and the electrical noises that it set up in the a-c line were completely eliminated.

Figure 1 is a circuit diagram of the life tester. The 6SJ7 tube oscillates at the frequency at which it was desired to operate the test set. This oscillating frequency is determined by the resistance-condenser tank circuit which serves as a modified long line or phase rotator. Each resistance-condenser section of the tank produces a phase rotation of somewhat less than 45° and therefore the four sections included in the tank rotate the phase at the particular frequency of oscillation somewhat less than 180°. The impulse coming from the plate and rotated in phase by the filter is fed to the grid of the same 6SJ7 thereby producing the condition necessary for oscillation.

If we plot the frequency against phase rotation, we obtain the curve shown as a dotted line in Fig. 2. It will be seen that the higher the frequency, the greater the phase rotation, becoming asymptotic at a phase rotation of 360° at infinite frequency, and starting with zero phase rotation at zero frequency. On the other hand, plotting the loss in the filter against frequency, we obtain the broken line

shown in the curve. If now we plot the component of the output signal of the filter which is 180° out of phase with the plate signal merely by multiplying the cosine of the phase angle by the output (with a constant input) we obtain the solid line shown in the curve.

This solid line reaches a maximum value at a phase rotation between 120° and 140° and at the frequency at which it reaches its maximum, the oscillator will oscillate. It will be noticed that the loss in the filter is such that a high gain amplifier tube is necessary in order to produce sustained oscillations, since the amplification in the tube has to exceed the loss in the filter. It is for that reason that a pentode with a high voltage amplification such as the 6SJ7 was used. With an oscillating circuit of this type little difficulty was experienced in producing oscillations as low as one cycle per minute. The four section filter was chosen for the sake of convenience, although a resistance-condenser network containing more sections might serve the purpose better.

The reactive component of the oscillating tube load impedance and the reactance of the coupling condenser into the filter network have been neglected. This was done because at the low fre-

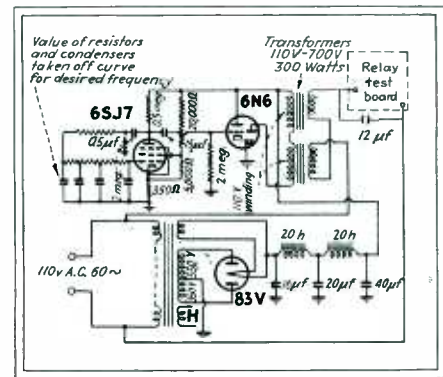

Fig. 1—Circuit diagram of the relay tester

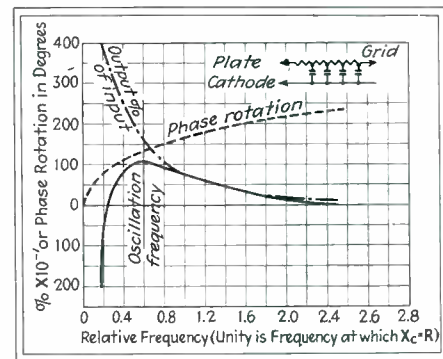
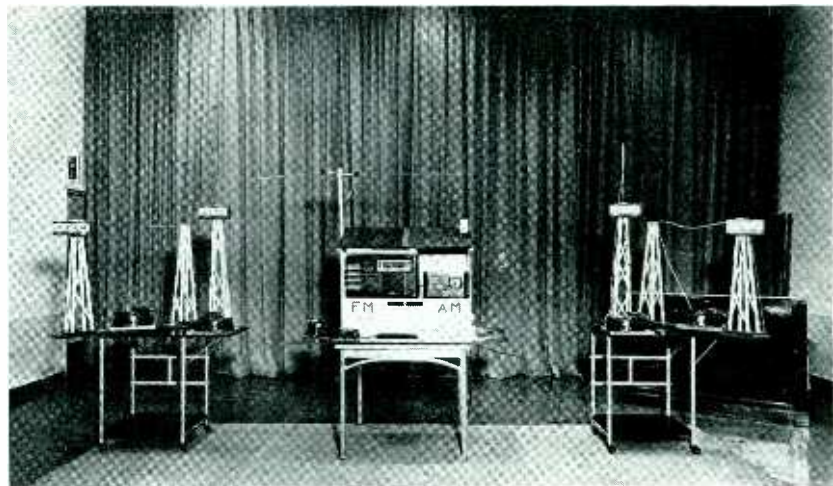

Fig. 2—Phase, frequency and output relationships

quencies generated by this oscillator, the resistance within the tube can be completely neglected and the coupling condenser to the filter can be made large enough to produce a negligible effect on the phase rotation and amplitude of the filter output. This is especially true since the frequency at which the oscillator oscillates can vary from its natural frequency without  
(continued on page 47)

## MINIATURE F-M NETWORK



Lee Chesnut, engineer in the G. E. Philadelphia office, has built two low-power f-m and two a-m transmitters for demonstrations. The transmitting circuits are housed inside record players which deliver recorded programs. Typical f-m and a-m receivers are used to demonstrate the improved relative noise-reduction and interference-reduction properties of the f-m system

# Get this new **OHMITE** Catalog and Manual

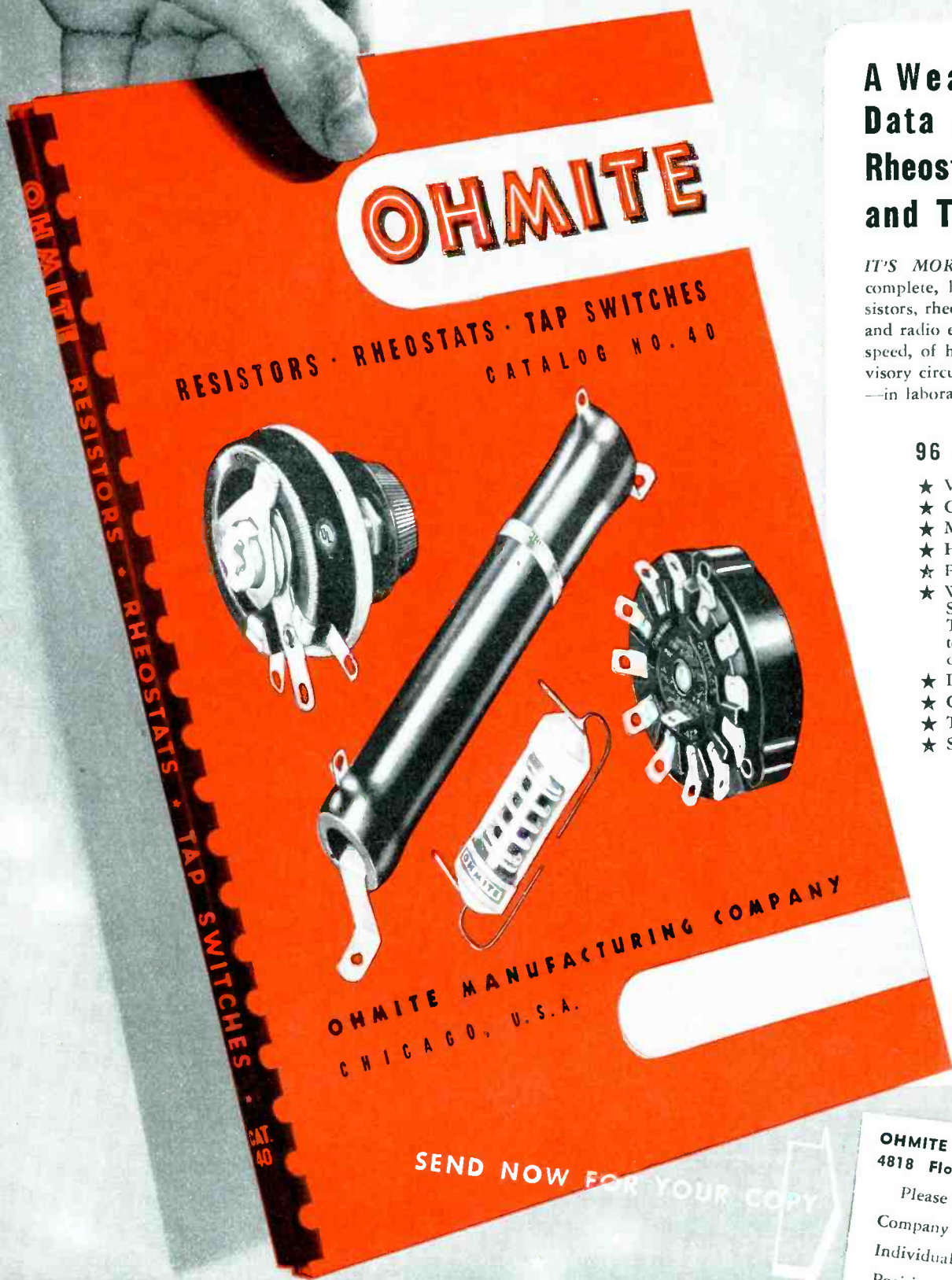

## A Wealth of Valuable Data about Resistors, Rheostats, Tap Switches and Their Applications

*IT'S MORE THAN A CATALOG*—it's a complete, handy reference on the use of resistors, rheostats and tap switches in electronic and radio equipment—in the control of motor speed, of heat and light, of signal and supervisory circuits—in products and machine tools—in laboratories, maintenance and production.

### 96 PAGES TELL EVERYTHING

- ★ Valuable Engineering Data!
- ★ Complete Dimensional Drawings!
- ★ Manual of Resistance Measurements!
- ★ Handy Reference Tables!
- ★ Practical Applications Information!
- ★ Wide Range of Stock Units and Special Units in Resistors, Rheostats, Tap Switches, Chokes and Attenuators, for R.F., Precision and Industrial Applications.
- ★ Describes New Products!
- ★ Covers the Most Complete Line.
- ★ Tells How to Select the Right Units!
- ★ Saves You Time, Effort and Money!

### THERE'S NOTHING LIKE IT!

It's truly an encyclopedia of helpful information—and invaluable guide packed full of tangible, usable data for engineers, production managers, and purchasing departments!

Clip this coupon to your company letterhead or write us on company stationery giving your name and position. Catalog 40 will be sent to you at once without obligation.

**OHMITE MANUFACTURING COMPANY**  
 4818 Flounoy Street, Chicago, U.S.A.

Please Send Catalog 40. No obligation.

Company Name .....

Individual Name .....

Position or Title .....

Address .....

City ..... State .....

Be Right with **OHMITE**  
 RHEOSTATS \* RESISTORS \* TAP SWITCHES

# NO "Doubtful Few"

## CAN SLIP THROUGH

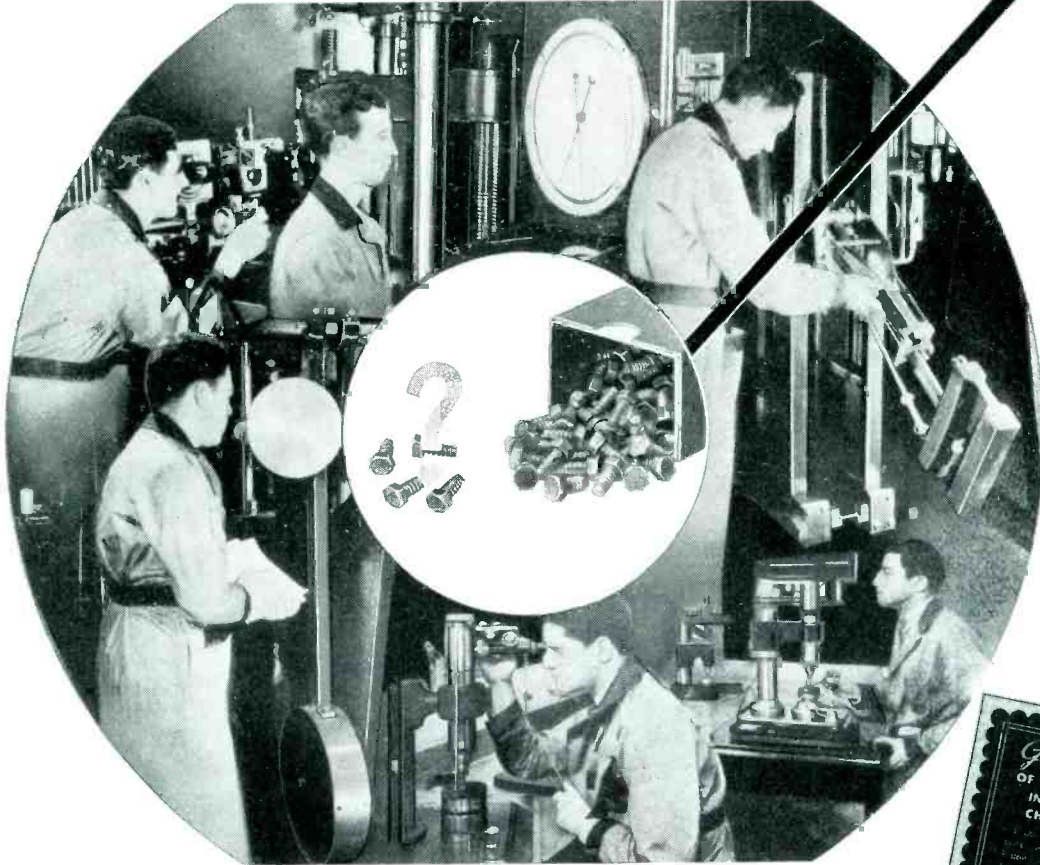

### Parker-Kalon's unique Quality-Control Laboratory rules out "doubtful" screws that threaten fastening jobs

Put Parker-Kalon Fastening Devices on your assembly line and you'll end troubles with the "Doubtful Few" . . . those few imperfect units in a box that won't drive properly or make satisfactory fastenings. Such screws are ruled out by Parker-Kalon's scientific "3rd degree" of tests and inspections.

A \$250,000 Quality-Control Laboratory that has no counterpart in the industry has made it possible to

hold Parker-Kalon Hardened Self-tapping Screws, Socket Screws, and other fastening devices to higher standards than ever before could be attained. Precision equipment controls every step in production. "Doubtful" units *can't* slip through!

Specify PARKER-KALON on your next order . . . get fastening devices guaranteed by the most modern plant in the screw industry. Parker-Kalon Corp., 192-194 Varick St., New York.

SOLD ONLY THROUGH RECOGNIZED DISTRIBUTORS

*Quality-Controlled* **PARKER-KALON**  
Fastening Devices

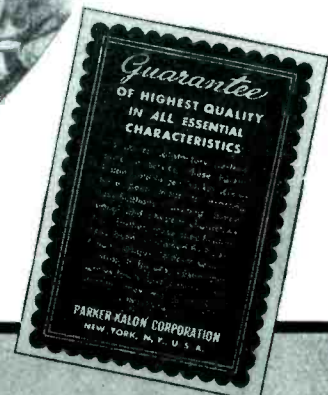

**COSTS NO MORE** to get this Parker-Kalon Quality-Control Guarantee with every box of . . .



**Hardened Self-tapping Screws**  
Types, sizes, head-styles for every assembly of metal or plastics

**Cold-forged Socket Screws**  
Cap Screws, Set Screws, Stripper Bolts made to a new high standard of quality



**Wing Nuts-Cap Nuts-Thumb Screws**  
Cold-forged . . . Neater, Stronger



being far removed from the peak of the curve (Fig. 2). The interesting side light on this type of oscillator is the fact that its grid is always fed through a resistance-condenser low pass filter which tends to eliminate its harmonics, in fact, in a four section network the second harmonic is attenuated 10 db below the fundamental.

The oscillating signal produced by the 6SJ7 was in turn fed to a 6N6 output tube with a peak plate current at zero bias in the order of 80 milliamperes. This plate current was used to saturate the cores of two step-up transformers, the primaries of which were connected in series with the 110 volts a-c line and the relay test panel. The secondaries, in the plate circuit of the 6N6, are so connected that whatever voltages were induced due to the voltage across the primary were made to cancel each other. The use of these saturated chokes to "key" the a-c line proved very satisfactory. Fifteen watts of d-c dissipated in a properly designed choke system of this type can key well over a kilowatt of alternating current.

. . .

### A Follow-Up Telemetering System

THE EDITORS ARE INDEBTED to the Esterline-Angus Co., of Indianapolis for information on their telemetering system which employs vacuum tubes to balance a follow-up telemetering system. The circuit diagram, shown in

. . .

### MILLIONTH-SECOND RADIOGRAPHS

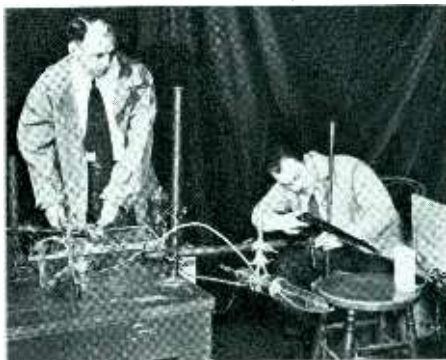

Dr. Charles M. Slack (left) and L. F. Ehrke, of the Westinghouse Research Laboratories at Bloomfield, with their equipment for taking X-ray exposures limited to a few microseconds. As described on page 56 of this issue, a cold-cathode X-ray tube, lower center, directs radiation through the block of wood to the photographic plate beyond. Charge stored in a condenser bank is released through the tube when the bullet hits the block

# 100,000 Fastenings A Day

## NO PLACE FOR "DOUBTFUL" SCREWS!



### That's Why PHILCO RADIO Specifies Parker-Kalon Self-tapping Screws

**Y**OU may make only 1000, instead of 100,000 fastenings a day, but you'll benefit, too, by avoiding "doubtful" screws... screws that are difficult to start, that strip, break or that won't draw up tight. It takes only a few trouble-makers in any lot to more than offset any savings in first cost.

When you demand Parker-Kalon Self-tapping Screws, you'll get no "doubtful" screws. Parker-Kalon's rigid Quality-Control insures that every screw will work right and hold tight.

Order Parker-Kalon and you get the best... products of the originators of the Self-tapping Screw... manufactured with specially-developed equipment and guaranteed by Parker-Kalon's Quality-Control Laboratory. Parker-Kalon Corp., 192-194 Varick Street, New York.



*Quality-Controlled*

TYPES, SIZES, HEAD-STYLES FOR EVERY ASSEMBLY OF METAL OR PLASTICS



**PARKER-KALON**  
HARDENED  
*Self-tapping Screws*



## for the life of the Equipment

Nothing takes the place of Kester Rosin-Core Solder in making permanent electrical connections.

This famous solder is scientifically developed in Kester Laboratories for this specific service. The especially prepared rosin-flux eliminates corrosion and gives extra protection against fire hazard.

Kester Rosin-Core Solder is specified for all types of electrical and radio work because it adds security and permanence to every installation. When circuits are soldered with Kester they require no further attention for the life of the equipment.

You are cordially invited to make use of Kester's 43 years of soldering experience. Write Kester engineers for expert advice on any soldering problems.

### KESTER SOLDER COMPANY

4204 Wrightwood Avenue

Chicago, Illinois

Eastern Plant: Newark, N. J.

Canadian Plant: Brantford, Ont.

**KESTER  
CORED SOLDERS**  
STANDARD FOR INDUSTRY

Fig. 1, illustrates the general principle of the system. The purpose of the equipment is to transfer the indications of a primary measuring element, which may be any type of meter employing a pointer, to a distant point and to reproduce the indications of this primary measuring element on another meter located at the distant point. To perform the transfer operation an auxiliary moving coil meter is used at the transmitting end of the system. This meter, called the translating milliammeter, contains a pointer, marked *C* in the diagram, which rests between two other contacts *L* and *H* on the pointer of the primary

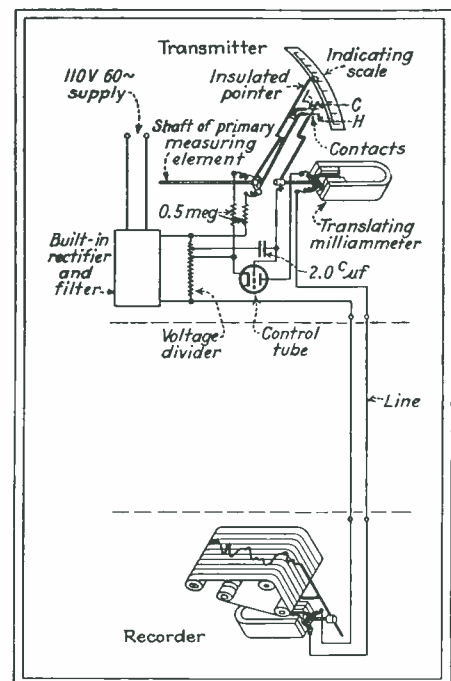

Fig. 1—Simplified schematic of the electronic telemeter system

measuring element. As the primary measuring instrument moves upward or downward on the scale, it encounters the pointer of the translating meter and the contact is made either on the high or on the low side, depending upon whether the primary pointer is moving down scale or up scale. The contact between the two sets of pointers is connected in the grid circuit of a control tube in such a way that negative voltage is applied to the grid of the tube if the contact occurs between the pointer elements *C* and *H*, whereas the grid is returned to cathode potential if the contact is between the pointer element *C* and *L*. The coil of the translating milliammeter is connected in the anode circuit of the control tube and hence the translating milliammeter pointer moves in response to the variation of the plate current of the control tube. Thus, when contact is made between the pointer elements *C* and *L* the plate current increases and the contact *C* tends to move away from the contact *L*. On the other hand, the

they may  
look alike



but what a difference  
in performance!



### Bird dogs or capacitors . . .

LOOKING AT THEM, it's hard to distinguish a green dog from a veteran game-getter. But on range bird hunting—what a difference in performance! Then there is no mistaking an old bird dog. He is eager, fast . . . knows a bird scent, how to untangle a trail, how to point. That takes experience.

This moral is pointed because capacitors, too, look alike. It is the hidden ingredients that makes the difference. That's why you get a finer performing, longer lasting, more dependable capacitor when you specify Cornell-Dubilier. C-D engineers are capacitor specialists, with the backing of the broadest experience in the industry—over thirty years. The superiority of today's Cornell-Dubilier capacitors is nobody's mere say-so, but proven performance, time-tested and most significant—acknowledged by the fact that there are more C-Ds in use today than any other make.

\*C-D ETCHED FOIL—NOT FABRICATED PLATE

**CORNELL-DUBILIER  
ELECTRIC CORPORATION**  
1006 HAMILTON BOULEVARD  
SO. PLAINFIELD, NEW JERSEY

*specify* **CORNELL-DUBILIER!**

THE WORLD'S LARGEST MANUFACTURER OF CAPACITORS...

PHOTOGRAPH COURTESY HUNTING AND FISHING MAGAZINE



Only Cornell-Dubilier  
Electrolytics offer  
all these **REAL**  
features

**Type BR\***  
Reg. U. S. Pat. Off.

### These Features:

- Special high-voltage paper separator
- C-D etched plate
- Special C-D electrolyte
- Special high formation process

### Result in:

- Minimum capacity change over wide temperature range.
- Great reduction in physical size—up to 40% for some types.
- Increased useful life.
- Reduced direct current leakage.
- Reduced equivalent series resistance.
- Higher breakdown voltage.
- Improved audio and radio frequency impedance characteristics.

The Type BR etched foil electrolytics are available in both single and dual capacity combinations. For complete technical information, send for engineering bulletin.

*Remember! All C-D capacitors are union made and competitively priced.*

Designed  
for  
Coverage

It may be assumed that station engineers are familiar with the electrical requirements of the vertical antenna best suited to local conditions. The matters of height, shape and insulation, however, closely relate to structural problems with which they may not be so familiar. Let Blaw-Knox engineers help you with these problems. They will be glad to cooperate with you in bringing the coverage of your station up to its maximum. Please feel free to call on them.

# BLAW-KNOX VERTICAL RADIATORS

BLAW-KNOX DIVISION of Blaw-Knox Company  
Farmers Bank Bldg., Pittsburgh, Pa.  
Offices in principal cities

DISTRIBUTOR  
**Graybar**  
ELECTRIC COMPANY

contact is made between *C* and *H*, the plate current reduces and the contact *C* tends to move away from the contact *H*. In this way the contact *C* is maintained at an average position midway between the two contacts *L* and *H*. A condenser *C* is used in the grid circuit to insure a comparatively slow change in grid voltage so that the motion of the contact is slow enough to assume a balanced position without hunting.

The plate current of the vacuum tube, having passed through the transmitting milliammeter, is passed through the connecting line between the transmitter and the receiving end of the telemetering system. The receiver consists simply of a direct current instrument whose scale is marked in the same units as the primary measuring element. A recording instrument may also be used, as shown in Fig. 1. Thus the receiving instrument reproduces exactly the indications of the transmitting milliammeter, and this latter instrument in turn is constrained to occupy a position corresponding with the pointer of the primary measuring element. The indications of the primary element are thereby transferred directly to the receiving end of the line.

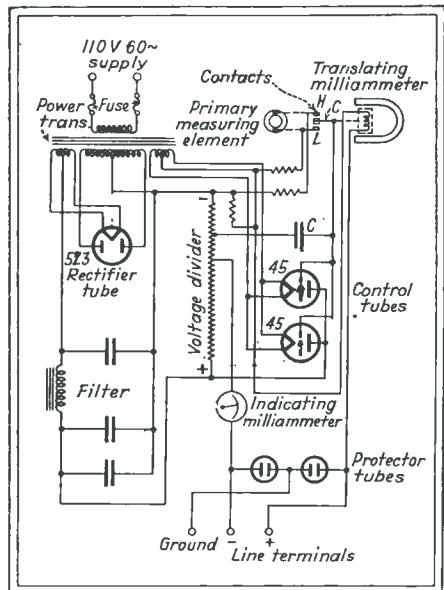

Fig. 2—Complete circuit diagram of telemeter transmitter

The complete circuit diagram of the transmitter is shown in Fig. 2. Two type 45 tubes are used in parallel with a maximum plate current drain of 20 ma per tube at a plate voltage of 275 volts, which is supplied by the 5Z3 rectifier. The maximum grid voltage is approximately 100 volts. The line used between the transmitter and the receiver must necessarily be a continuous metallic circuit. The voltage and current rating of the instrument are considerably below the maximum rating imposed by the telephone companies for such lines. In the telephone line open circuits, two protective neon glow tubes take up the load and pro-

# WESTINGHOUSE RADIO TRANSMITTING TUBES

ANOTHER WESTINGHOUSE  
"FIRST"...

## **AIR-COOLED TUBES**

### **FOR 50 KW TRANSMITTERS**

were first developed, placed in service, and "performance proved" by Westinghouse.

Westinghouse continues to demonstrate its leadership in the field of Radio Transmitting Tubes.

For full details and order service on Westinghouse Radio Transmitting Tubes, just call the Westinghouse Electric & Mfg. Co. sales office in your territory.



# Westinghouse

*The first name in radio broadcasting*

# RELAYS

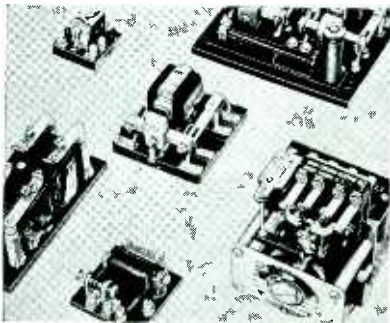

The Ward Leonard Line of Relays comprises light, intermediate and heavy duty, sensitive, transfer and time delay types for every application. They all have crisp action, are dependable and durable yet consume but little current. Various Ward Leonard Relays are described in "W.L. Relay Bulletins."

# RESISTORS

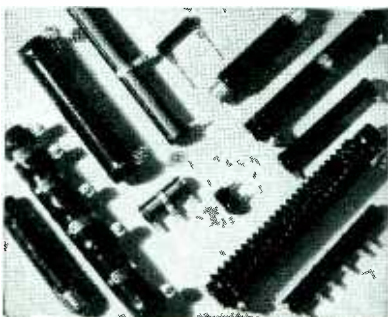

More than 10,000 Electrical and Industrial Engineers are using Ward Leonard Data Sheets as Resistor reference guides. Ward Leonard Resistors cover a wide range of sizes, ratings, enclosures and terminals. You will most likely find your "special" is a Ward Leonard "standard." Send for "W.L. Resistor Bulletins."

# RHEOSTATS

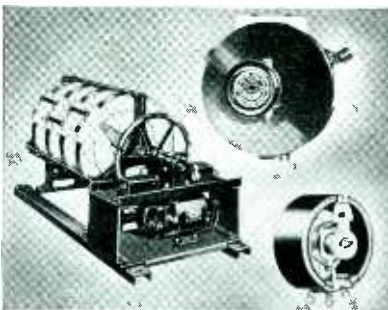

Ward Leonard Line of Rheostats includes everything from small types for fractional H.P. motors to the largest multiple units to control heavy current requirements. Ward Leonard Rheostat Bulletins fully describe types, drives, mountings and accessories. The Ward Leonard Line is complete. Send for "W.L. Rheostat Bulletins."

# WARD LEONARD

**ELECTRIC (WL) COMPANY**

*Electric Control Devices Since 1892*

Ward Leonard Electric Company, 32 South Street, Mount Vernon, N. Y.

Please send me bulletins on Relays ( ) Resistors ( ) Rheostats ( ).

Name .....  
 Firm .....  
 Address .....  
 City ..... State .....



protect the tubes and meters from excessive voltage. This arrangement protects the transmitting equipment should the voltage across the line rise above 120 volts, as in the event of an open circuit. The tubes also bypass lightning surges.

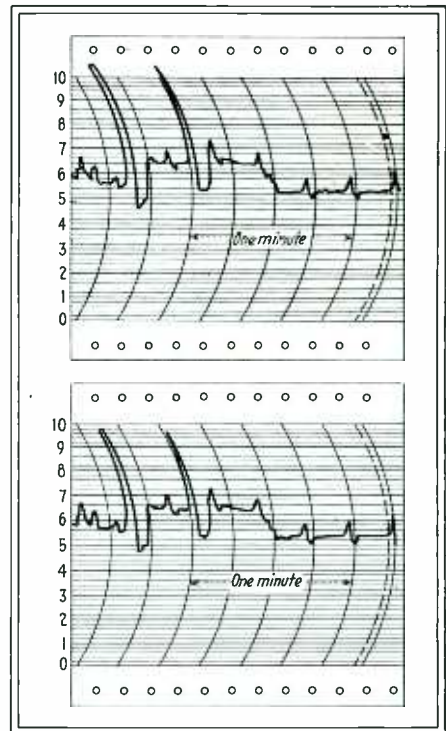

Fig. 3—Original graphic meter record (above) and telemeter reproduction

The speed of response of the telemetering system is limited by the values of resistance and capacitance in the grid circuit of the control tube. The minimum time which can be built into the instrument without incurring hunting is about 2 seconds for a complete traversal of the scale from maximum to minimum. By increasing the values of resistance, a traversal time

## TESTING THE SOLOVOX



Laurens Hammond, right, and John Hanert checking the inner workings of the Solovox, a three-octave electronic music generator for use with a piano. The pianist may play the Solovox with one hand while accompanying himself with the other



THIS FELLOW HAS BEEN  
**BLITZKRIEGED**  
OUT OF A JOB

Official U.S. Army Photographs

## TODAY'S ARMY HAS AN ELECTRONIC SIGNAL CORPS

Lightning War waits for no brave and picturesque dispatch rider.

With the World combatting or preparing for armies that strike and even conquer overnight, the acquisition and use of adequate and effective electrical communication is an essential element in our preparedness program.

Telephone, telegraph, radio and facsimile—these are the swift couriers of World War II. And they are consequently the lifeline of national security for the United States. Through them local, national and hemispheric defense will be coordinated and directed.

The United States Army, along with our other

armed forces, has no peer in the development and use of wired and radio communication. We believe that this is a logical condition in the nation that enjoys the finest commercial communication operating and manufacturing facilities in the World.

The electronic industry, which has been the able and willing partner of the Signal Corps in pioneering and developing military communication systems, is already prepared to fulfill its part in the National Defense Program. The industry is proud of the operating and manufacturing facilities it can make available to the Government during its program for adequate national security.

*An Institutional Message from ELECTRONICS, the Authoritative Voice of the Electronic and Allied Industries*

THE ELECTRONIC INDUSTRY IS A VITAL ELEMENT IN NATIONAL DEFENSE

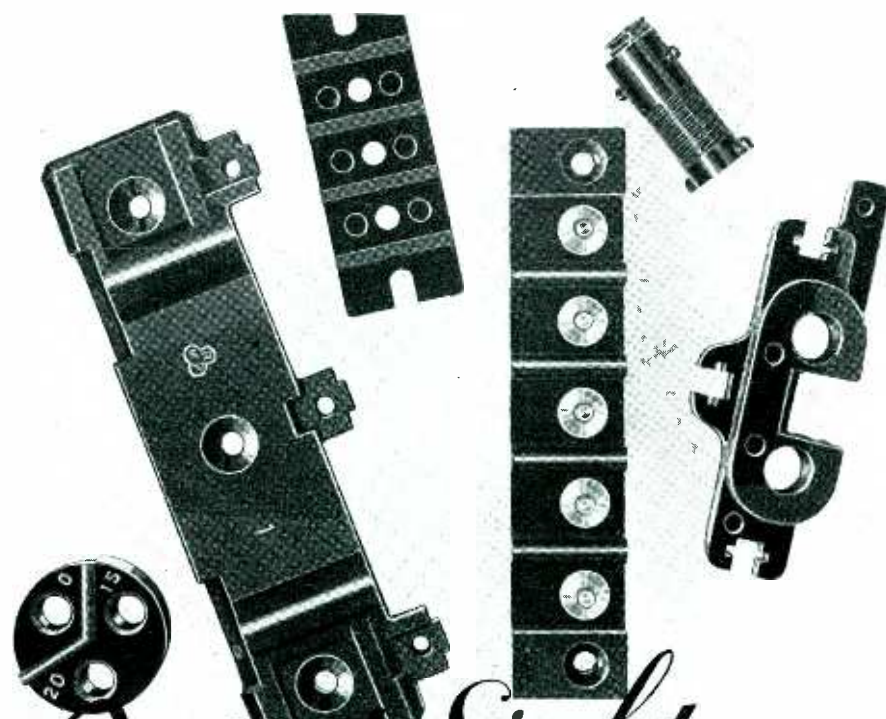

# Out of Sight Out of Mind

That's the reward for using INSUROK electrical insulation — installed and forgotten. This precision plastic possesses qualities and characteristics that make it wholly dependable.

## INSUROK

### the Superior Precision Plastic

When Richardson set about to produce a plastic for the electrical industry, only one result was sought—the product must be the best that could be produced. How well INSUROK met this requirement is proved by its increasingly widespread use where difficult operating conditions are encountered, by its ability to deliver the utmost satisfaction, out of sight, and out of mind.

**RICHARDSON TECHNICAL SERVICE.** Many users of INSUROK find Richardson Technical Service indispensable. You are invited to avail yourself of these comprehensive facilities — without obligation, of course.

## The RICHARDSON COMPANY

MELROSE PARK, CHICAGO, ILL.    FOUNDED 1858    LOCKLAND, CINCINNATI, OHIO  
 NEW BRUNSWICK, N. J.    INDIANAPOLIS, IND.  
 DETROIT OFFICE: 4-252 G. M. BUILDING, PHONE MADISON 9386  
 NEW YORK OFFICE: 75 WEST STREET, PHONE WHITEHALL 4-4487

of as long as 10 seconds is entirely practical. Ordinarily the grid condenser is 2 microfarads and the grid resistors are 500,000 ohms, making an effective time constant of one second. The grid condenser is an oil filled unit of 1,000 volts rating.

Since the telemetering system operates on a balanced principle, it is independent of the characteristics of the tubes, and also of the characteristics of the telephone line employed, provided that the line does not introduce excessive leakage of the current passed from the transmitter to the receiver. Since the system works on direct current, there is no problem of synchronism between the transmitting and receiving ends of the line. Fig. 3 shows a section of a graphic record of a wattmeter taken at the transmitting and receiving ends of a typical telemetering system of this type, with the chart speed at 3 inches per minute. The system will work with lines having a series resistance not exceeding 2,500 ohms, which correspond to a distance of about 28 miles when No. 19 gage wire is used in the circuit. With No. 12 gage wire a distance limited to 134 miles is possible. The insulation resistance of the line should preferably be 100 times as great as the series resistance of the circuit, that is, the minimum leakage resistance should be 250,000 ohms. For this reason cable circuits are to be preferred to open wire circuits for the operation of this device. The device operates at an average power requirement of 65 watts, maximum 100 watts, at 115 volts. The transmitter operates throughout the range from 105 to 125 volts.

### AUTOMATIC WEATHER REPORTER



A radio-operated weather-reporting device has been developed for the Navy by W. S. Hinman and Harry Diamond of the Bureau of Standards. The apparatus now in operation at the Anacostia Naval Air Station will deliver information on barometric pressure, air temperature, relative humidity, wind direction and velocity and rainfall, at predetermined intervals





Designed for FM...  
 Built by Western Electric  
 ...installed by WOR...  
**ASK YOUR ENGINEER!**

## Studio Control Desk Speech Input Equipment for YOU!

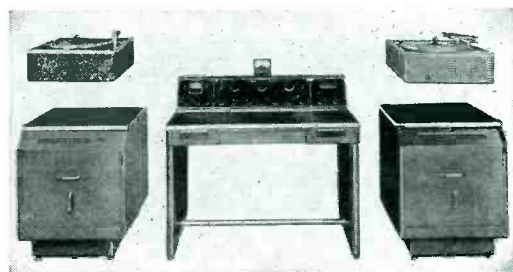

### Arrange It To Fit Your Requirements

Table unit houses pre-amplifiers and control circuits—one or two pedestal units house main and monitor amplifier circuits and accessory equipment—turntables mount on top of pedestals. Use whatever units you need—arrange them to suit yourself. Complete *circuit flexibility*, too.



**DISTRIBUTORS:** In U.S.A.: Graybar Electric Co., Graybar Bldg., New York, N. Y. In Canada and Newfoundland: Northern Electric Co., Ltd. In other countries: International Standard Electric Corp.

Here is the most complete, flexible, compact Studio Control Speech Input Equipment you could ask for!

Developed by Bell Telephone Laboratories and used with WOR'S new Western Electric Synchronized FM Transmitter, these Desk Units can be "custom-equipped" and arranged to the exact needs of *your station*—whether FM or AM.

Quality equipment in every

way—these units are built to help you easily attain and maintain overall system transmission standards established by FCC for FM.

Your sponsors will be attracted by their clean-cut *beauty*—your staff will find them easy to install, easy to operate, easy to maintain.

Get full details—ask Graybar for Bulletin T1758.

# Western Electric

# Something to Remember

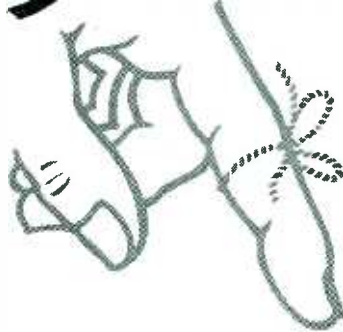

WHEN YOU DESIGN  
RADIO, TELEVISION  
AND ELECTRONIC  
EQUIPMENT

**S. S. WHITE  
FLEXIBLE SHAFTS  
for COUPLING**



*Here's why . . .*

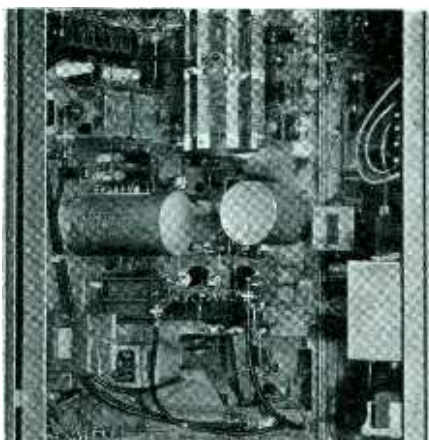

Section of the interior of an RCA Broadcast Transmitter. Note the effective arrangement of units and centralizing of controls made possible by the use of S. S. White Flexible Coupling Shafts.

By using S. S. White Flexible Shafting for coupling control knobs to their respective condensers, variable resistances, inductances, transformers, switches etc. you are free to locate both knobs and units wherever you want to place them to get these advantages:

- Circuit Efficiency
- Centralized Control
- Space Saving
- Ready Assembly
- Easy Servicing

Specially developed for remote control, S. S. White Flexible Shafting has the necessary characteristics for smooth, easy sensitive adjustments.

#### ENGINEERING BULLETIN 38

tells the story. Write for your free copy today.

## S. S. WHITE

The S. S. White Dental Mfg. Co.

### INDUSTRIAL DIVISION

Department E, 10 East 40th St., New York, N. Y.

**FLEXIBLE SHAFTS for POWER DRIVES, REMOTE CONTROL and COUPLING**

## Bell Labs Reveal New Developments at Physical Society

AT THE JUNE MEETING of the American Physical Society in Pittsburgh, engineers of the Bell Telephone Laboratories revealed several interesting new devices and materials of interest in the electronics field. W. B. Ellwood describes a new ultra-micrometer. This instrument is used for measuring the thickness of non-magnetic coatings on sheet iron. The accuracy of measurement is less than one one-hundredth thousandth of an inch, and the measurement is made without injuring the coating. Two iron rods are used, one pressed against either side of the coated iron sheet. Each rod is wound with two coils of wire. The rods are magnetized equally by passing alternating current through one of the coils which induces currents in the other two coils. The amount of the induced current depends on the thickness of the coating on the sheet. Any non-magnetic coating, either metallic or non-metallic, may be measured.

C. B. Green and G. L. Pearson described a resistor which has an inverse temperature coefficient, that is, the resistance decreases as the current flow through it increases. This substance is employed in connection with a voltage regulator by using an ordinary resistor and a thermistor, as the new resistor is called, in series. The voltage across the combination may thereby be stabilized over a wide range.

A new alloy composed of cobalt, vanadium and iron, and known as Vicalloy was described by E. A. Nesbitt and G. A. Kelsall. The material has a very high degree of retentivity for permanent magnetism and at the same time has very desirable physical properties. The alloy may be rolled into tape 1/500 inch thick and 1/20 inch wide, and is especially suitable for use in sound magnetic tape sound-recording machines. Several thousand feet of this material are used in the Bell Laboratories demonstration at the New York World's Fair. Endless loops of the same tape are used in the Bell Telephone weather-announcing systems. Vicalloy contains 6 to 16 per cent vanadium, 30 to 52 per cent iron, 36 to 62 per cent cobalt, and is cast into an ingot from the molten state. The metal may then be drawn or rolled into tape, and is finally heat-treated.

. . .

## Cold Emission Used In Microsecond Radiography

A COLD CATHODE X-RAY TUBE which can make useful exposures in a time as short as one millionth of a second has been developed by Dr. Charles M. Slack of the Westinghouse Lamp Division, who described it before the American Physical Society in the June meeting. The circuit arrangement of the X-ray used is shown in the accompanying diagram. The tube itself con-

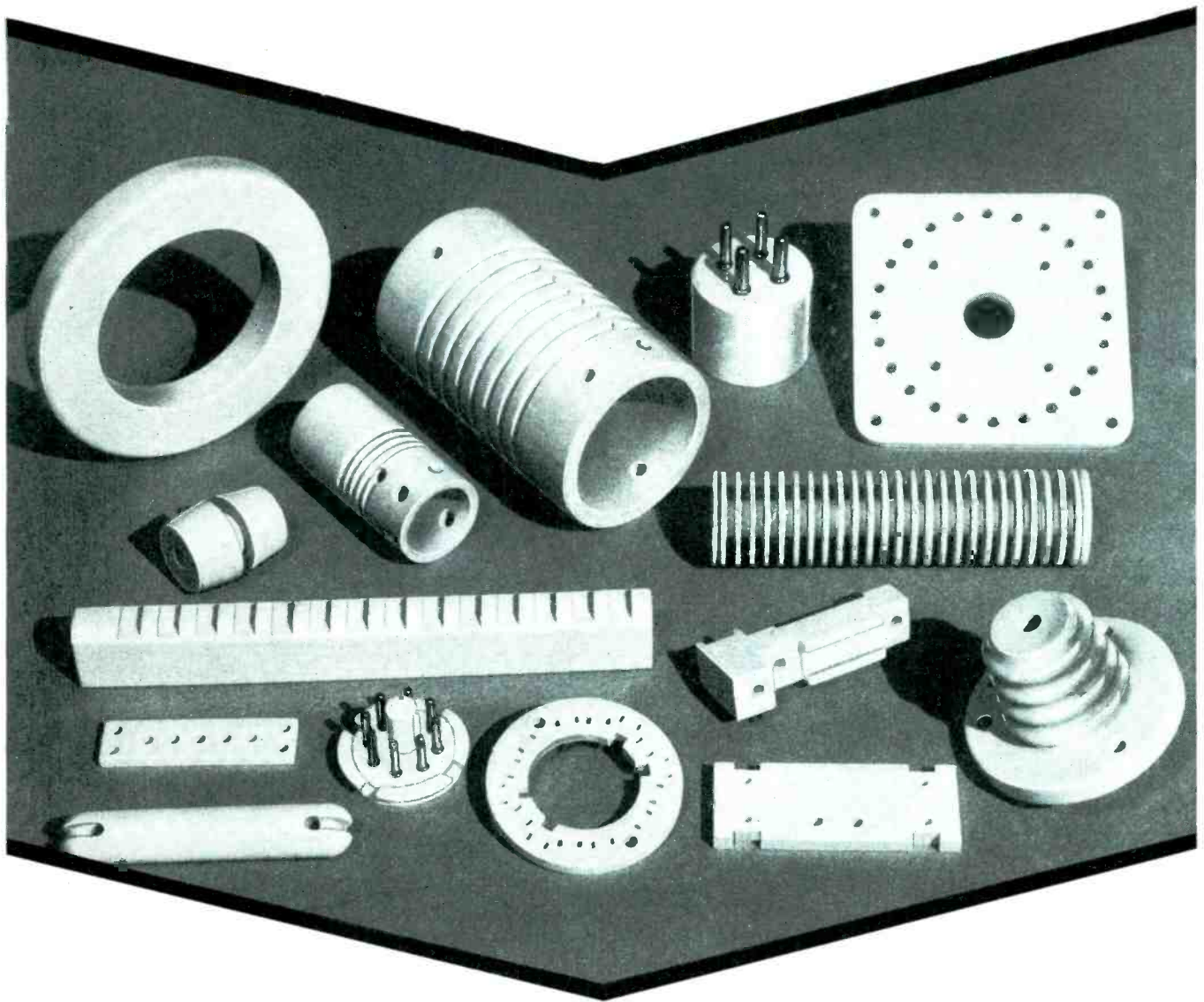

## Do You Recognize Them?

A famous engineer regularly tears down and checks every model produced by his competitors. Chatting with another engineer, he expressed amazement that he recognized in AISiMag advertisements the insulators used in almost every leading product in his field.

We believe that there are limitless designs and shapes for insulators . . . but that AISiMag offers you the BEST in "bodies" and workmanship. We are glad that so many great engineers agree with us . . . and that we can produce more than 15,000 different designs a year, promptly, accurately, economically.

# AISI MAG

Trade Mark Reg. U.S. Pat. Off.

FROM CERAMIC HEADQUARTERS

**AMERICAN LAVA CORPORATION • CHATTANOOGA • TENNESSEE**

CHICAGO • CLEVELAND • NEW YORK • ST. LOUIS • LOS ANGELES • SAN FRANCISCO • BOSTON • PHILADELPHIA • WASHINGTON, D. C.

# New Low in Noise Level

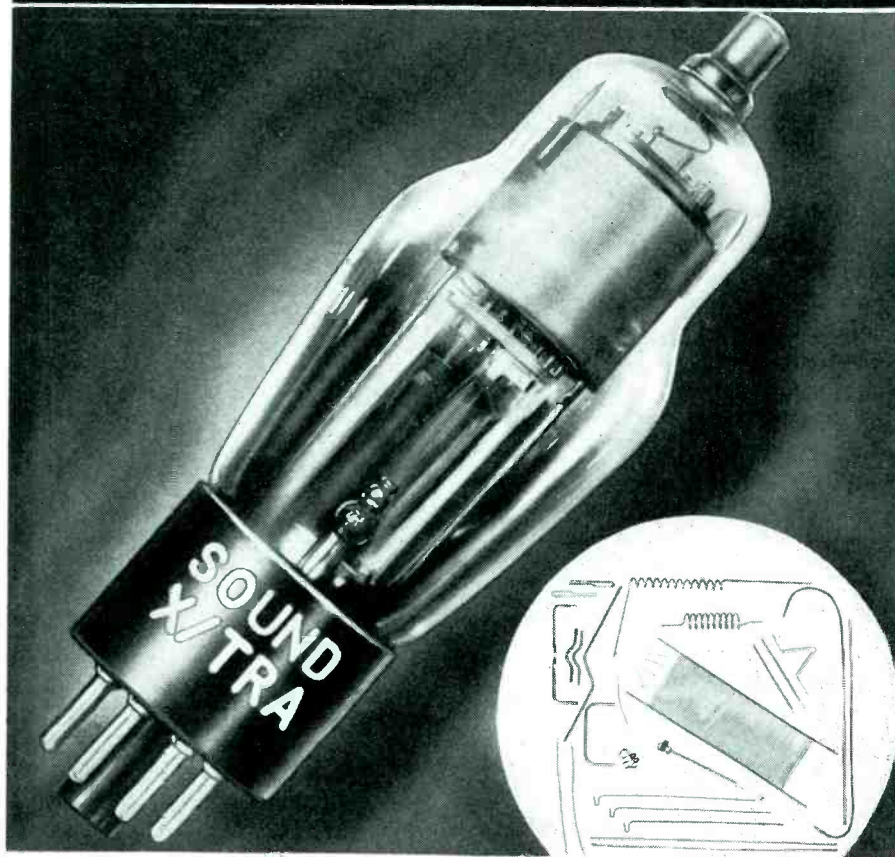

## an achievement of CALLITE GRID WIRE and FILAMENT WINDINGS

MODERN amplifier design has advanced to a point where ordinary radio tubes have become inadequate. Recently the National Union Radio Corporation introduced a new line of custom-built tubes developed especially for sound system applications—tubes which eliminate or radically reduce the triple threat of hum, microphonics and internal noise.

In perfecting their new series of "Sound X'tra" tubes, in which long life, unusual ruggedness and exact uniformity of electrical characteristics are essential features, National Union engineers naturally looked to Callite for grid wire and heater windings.

Callite's reputation for resourcefulness

and dependability has, in fact, been solidly established over the years by just such achievements as this in the field of electron emission tubes.

Its double helical filament windings eliminate a prolific source of hum. Callite's "Calmolloy" grid wire can be worked to tolerance within 1/10,000 of an inch, or better. These are merely two of the "metallurgical miracles" credited to Callite-Tungsten development in formed parts.

It may be that Callite's broad knowledge and specialized experience, applied to your particular problem, can save you both time and money. Send for informative literature.

**CALLITE TUNGSTEN**  
CORPORATION

544-39th STREET • UNION CITY, NEW JERSEY

Cable: "CALLITES"

sists of a cold cathode, *G*, a trigger element, *H*, and an anode, *I*. The voltage doubler rectifier, *A*, charges a bank of condensers to approximately 90,000 volts, which is applied between cathode and anode in series with the

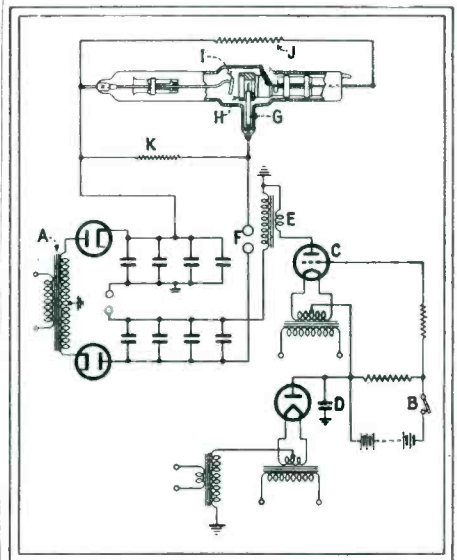
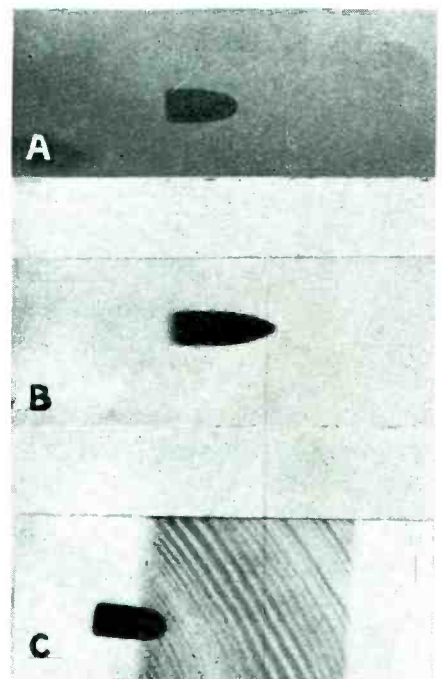

Diagram of power and control system

gap, *F*. The control tube, *C*, which operates when the switch, *B*, is opened, induces an extra voltage in the gap circuit and causes the gap to flash over, so that the full voltage of the condenser bank is applied between the cathode and anode with the X-ray tube. Through the resistance, *J*, the anode potential is also applied to the trigger electrode, *H*, which draws "cold" emission from the cathode. The emission is focused by the trigger electrode on the anode where it produces



A, .22 bullet in flight; B, .22 Swift bullet, exposure time, one micro second; C, bullet entering wood block

X-rays which are passed through the radiographed object to the recording film.

During exposure the current through the tube may range from 100 to 2,000 amperes over a period of approximately one microsecond. This extremely high current enables Dr. Slack to expose the photographic film

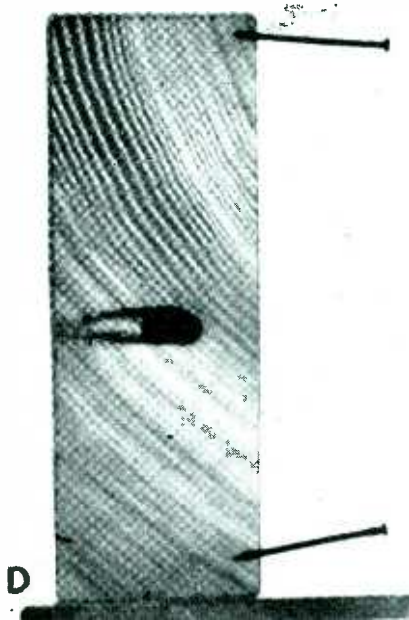

Bullet half-way through. Note wood closing behind bullet

in so short a time. Ordinary X-ray tubes, employing thermionic cathodes operate with currents considerably less than one ampere. If a thermionic cathode were used in this tube it would be destroyed because of the extremely heavy instantaneous current.

In using the equipment Dr. Slack and his associates have made pictures of various swiftly-moving objects. In the accompanying photographs are shown radiographs of moving bullets shot from a .22 rifle. The speed of



Bullet just emerging from block. The nails hold control wire

## Having turntable trouble?



Presto 63-A dual speed 16" transcription table with pickup mounting bracket. Base plate is drilled to mount selector switch and scratch filter.

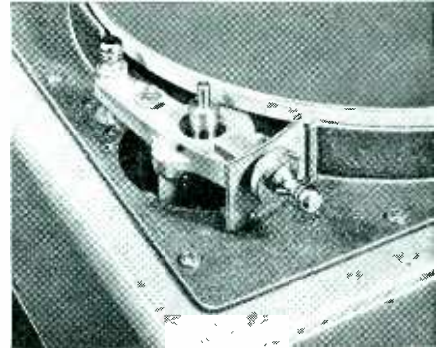

Unique Presto drive system. Step pulley on motor shaft drives against rubber tire on turntable rim. Lever changes speed instantly from 78 to 33 1/3 RPM.

## JOIN THE SCORES OF RADIO STATIONS that are removing the playback pickups from their old transcription tables and remounting them on the new Presto 63-A table.

It's a simple change to make, because the Presto table is furnished with brackets to mount any standard make of vertical or lateral pickup and the base is drilled to mount your compensator controls and scratch filter. The entire change-over takes an hour at the most and costs very little.

You'll marvel at the reproduction of your transcriptions played on the 63-A table. It's the quietest, smoothest running turntable we've ever produced and it runs for months at a time with no service whatever. The new Presto drive system—a heavy, live rubber tire on the turntable rim driven by a steel pulley on the motor shaft—has only 2 moving parts, requiring a simple adjustment once or twice a year. Speed accuracy is .3%—less than 3 seconds time error on a 15 minute program. Vibration is negligible. Leading firms use and recommend the 63-A for playing both vertical and lateral recordings.

Give new life and realism to your transcribed broadcasts this

fall. Install Presto turntables now. Literature and prices on request.

### Recent purchasers include:

Associated Music Publishers, Canadian Marconi Co., Columbia Broadcasting System, Columbia Recording Corp., Federal Tel. & Tel. Co., Northern Electric Co., Westinghouse Radio Stations. Also stations KICA, WBNS, WBRW, WHO, WJMS, WMEX, WSYR, WTRY and Advertising Agencies Fuller & Smith & Ross, Inc., Lennen & Mitchell, Wm. Esty & Co., Maxon Advertising Agency and others.

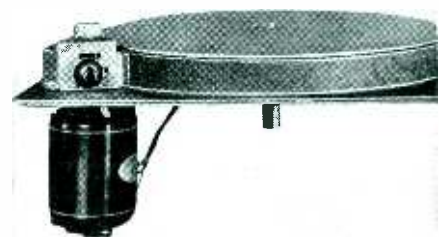

Presto 10-A turntable chassis only for mounting in existing cabinets.

Canadian Distributor: WALTER P. DOWNS, 2313 St. Catherine St. W., Montreal, P. Q.

**PRESTO RECORDING CORPORATION**  
242 West 55th Street, New York, N. Y.  
World's Largest Manufacturers of Instantaneous Sound Recording Equipment

## ONLY RELAY USERS NEED TO READ THIS

Write today for Circular 1653Q.

It describes two amazing new Automatic Electric relays with qualities and features possessed by no other low-priced relay.

In three months, thousands have been purchased in place of "cheap" relays. (Cost is the same.) Experience of users reveals these benefits:

1. Reduced assembly costs (relays are preadjusted)
2. More reliable operation (contacts have heavy pressures — are "self-cleaning")
3. More positive action (armature restored by leaf-spring)
4. No over-heating (coil is "self-protecting").

Circular 1653Q explains these and many other advantages, and gives prices; also tells *why* you can buy this higher-quality relay at *no extra cost*. Write today.

**AUTOMATIC ELECTRIC**

Relay Makers Since 1898

1033 W. Van Buren Street

Chicago

the exposure was determined by the picture shown in B which is of a No. .220 Swift bullet moving at 4,000 feet per second. The radiograph shows a motion of approximately 1/20 of an inch indicating an exposure of approximately one microsecond. The

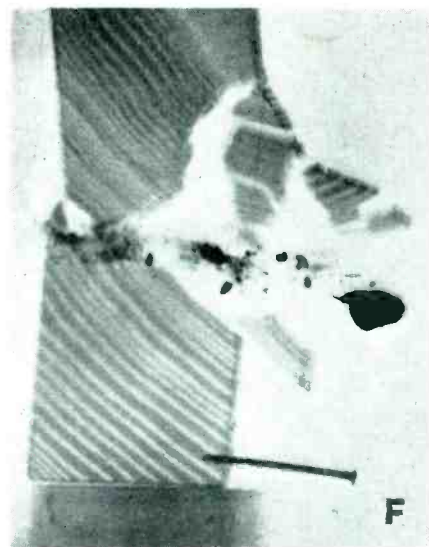

Bullet beyond block, with trail of lead behind it

other photographs show the progress of a standard .22 rifle bullet through a block of wood. Exposures were made at different times, with different bullets, but all of the same calibre. The radiograph shown at D shows an interesting effect in the wood which has tended to close up behind the bullet as a result of elastic deformation. The other pictures show an exploded block of wood as the bullet emerges from it. The nails carry a fine wire connected in the grid circuit of the control tube, which initiates the exposure when the circuit is broken.

### WARTIME CHECKING



The British Broadcasting Company maintains a constant watch on foreign broadcasts. Above is shown a "staff monitor" taking notes from a two-cylinder dictaphone which makes continuous records of enemy propaganda

## THE ANSWER

to your resistor problem may be found in these characteristics of

**GLOBAR BRAND CERAMIC RESISTORS**

REG. U. S. PAT. OFF.

1. *Non-Inductive*
2. *Electrically stable*
3. *Mechanically strong*

● These three characteristics are important in a great many applications. Perhaps they may lead to a solution of your own resistor problem. Our engineering department will gladly help you if you write and outline your requirements. Bulletin R contains technical information on "Globar" type A, B and CX ceramic resistors. Will be sent free on request.

**GLOBAR DIVISION  
THE CARBORUNDUM COMPANY, NIAGARA FALLS, N. Y.**

REG. U. S. PAT. OFF.

Carborundum and Globar are registered trade-marks of The Carborundum Company

**Globar CERAMIC RESISTORS**

BRAND

**Precision Built**  
ON MODERN HIGH SPEED EQUIPMENT

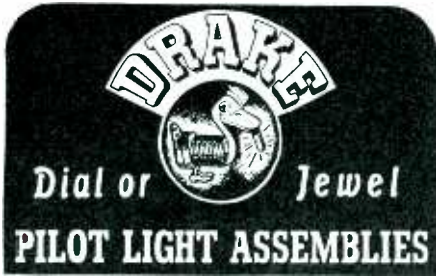

The correct design and manufacture of good pilot light assemblies is a job for experts. Years of specializing in this field have resulted in our developing a highly skilled organization, precision methods, and high-speed equipment that produces the finest possible units at moderate cost. If one of our many standard designs does not exactly fit your needs, our competent engineers will gladly design a special unit for you. Test DRAKE Service. You, like so many other leading electrical manufacturers, will find it sincere and efficient.

SEND FOR CATALOG TODAY!

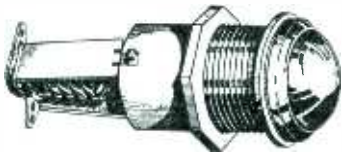

**DRAKE MANUFACTURING CO.**  
1713 W. HUBBARD ST. • CHICAGO, U. S. A.

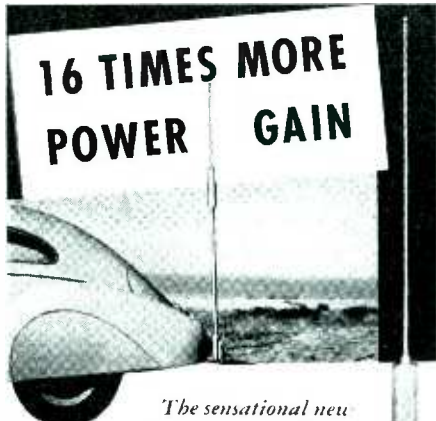

**16 TIMES MORE  
POWER GAIN**

*The sensational new*  
**TOP LOADED ANTENNA**

You'll find this new antenna a definite step ahead for portable and mobile equipment both receivers and transmitters. The ideal antenna for patrol applications on the low frequencies. 10 watts transmitter power will give an excellent signal over a 25 mile radius. This new Wunderlich Controlled Current Antenna will give a power gain of 16 times (12 db) over the conventional base-loaded fish pole type. It is especially effective in the 1000 to 6000 kc spectrum. Radio engineers are invited to write for more information... there's no obligation.

**WUNDERLICH**  
Controlled Current Antenna  
Address all communications to  
**WUNDERLICH RADIO, INC.**  
S. F. AIRPORT  
SOUTH SAN FRANCISCO, CALIFORNIA

\* Pat. applied for.

**FM- 105 Hours  
Per Week**

(Continued from page 19)

operates as follows. When the oscillator is unmodulated, it produces a single frequency, which when frequency divided has the value of about 5,300 cps. The frequency-divided output of the crystal oscillator has exactly the same frequency. Under this condition there is no rotating magnetic field in the correction motor. Suppose however that the frequency of the modulated oscillator (still in the absence of modulation, however) starts to drift. Then the frequency divided output drifts in proportion, while the crystal output remains at 5,300 cps. The frequency difference between the two sources gives rise to a rotating magnetic field in the motor, which causes the rotor to turn, changing the tank circuit capacitance until the drift is corrected. Whereupon the rotating magnetic field ceases and the motor stops, ready for the next drift.

When modulation is applied to the oscillator, the frequency divided output tends to shift back and forth in phase by a small amount at the audio frequency rate. The rapidly reversing magnetic field resulting from these phase changes has no rotational effect on the motor since the motion is damped out by the mechanical inertia of the motor rotor and the attached capacitors. Hence the frequency-control circuit does not respond to modulation, but it does respond to any change in the center frequency of the transmitter. Drifts in frequency of a megacycle or more can be corrected in this manner, although drifts of more than a few hundred kc are rarely encountered in practice.

The frequency control system, it will be noticed, is entirely divorced from the signal circuit from microphone to antenna, and in fact the frequency control circuit may break down altogether without putting the station off the air. Moreover the frequency control depends only on the frequency difference between the two 5,300 cps sources, not on their

**STACK-MOUNTING  
Heavy-duty  
CAPACITORS**



Above, the largest size, or Type 1940 capacitor, with the medium size or Type 1960 at right. Choice of five sizes.

Yes, the Aerovox line includes these stack-mounting mica capacitors for various transmitting applications such as grid, plate-blocking, coupling, tank, and by-pass functions. Special cylindrical low-loss glazed ceramic case for long creepage between terminals. Corona losses eliminated inside and out. Cast-aluminum terminal ends provide low-contact-resistance between units. Finest grade India ruby mica dielectric. Made to closest tolerances to equalize loading of series-connected sections.

**Available in Five Sizes**

Type 1940: Overall dia. 9"; Overall height 10"; .00001 to .01 mfd.; 15,000 to 35,000 test volts eff.

Type 1950: Overall dia. 3-13/16"; Overall height 2 1/2"; .00001 to .02 mfd.; 3000 to 6000 test volts eff.

Type 1960: Overall dia. 5"; Overall height 3"; .00001 to .25 mfd.; 1000 to 15,000 test volts eff.

Type 1970: Overall dia. 6 1/2"; Overall height 4"; .00001 to .5 mfd.; 1000 to 20,000 test volts eff.

Type 1980: Overall dia. 6 1/2"; Overall height 5 3/4"; .00001 to .05 mfd.; 5000 to 35,000 test volts eff.

Max. current in amps., at max. ambient temperature of 60° C. stated for 3000, 1000, 300 and 100 kc, in catalog sheets available.

**Transmitting Catalog...**

Full data and literature covering this and other capacitors for transmitting and other heavy-duty requirements, sent on request to any designer, engineer or builder of radio or electronic equipment, writing on business letterhead.



# communications



Model SX-28 Super Skyride is a 6 band, 15 tube receiver giving you complete front panel control over every phase of the circuit. 2 stages of preselection . . . high fidelity push-pull audio . . . calibrated electrical bandspread . . . micrometer scale on main tuning knob . . . 6-position selectivity control . . . band pass audio filter . . . automatic noise limiter . . . new crystal filter circuit . . . ball bearing tuning mechanism . . . semi-floating main tuning and bandspread condensers. Covers 540kc to 43mc. Panel is exact rack size. Chassis has rigid girder construction. Hallicrafters-Jensen Bass Reflex speakers available. With crystal and tubes, less only speaker . . . \$159.50 NET

USED BY 33 GOVERNMENTS  
SOLD IN 89 COUNTRIES

Model S-27 is the first general-coverage U.H.F. communications receiver to incorporate Frequency Modulation reception. Covers 3 bands: 27 to 46mc; 45 to 84mc; 81 to 145mc. Switch changing from FM to AM reception. Acorn tubes in R.F. and newly developed converter system. High gain 1853 tubes in I.F. stages. Beam power tubes and 6C8G phase inverter in A.F. Amplifier. A VR 150 voltage regulator tube is used to assure excellent electrical stability. 955 plate-tuned oscillator. I.F. selectivity automatically sharpened to receive amplitude modulated U.H.F. signals or broadened for wide band frequency modulated signals. With tubes, less only speaker . . . \$175.00 NET



# hallicrafters

amplitudes, and hence is independent of tube characteristics, etc.

The frequency-divider circuits are of interest in that their output is always one-half of the input frequency, regardless of what that input may be. A balanced bridge-type modulator, shown in the Figure, accepts the input frequency across one diagonal, and feeds an amplifier across the other. A portion of the output of the amplifier is fed back to the modulator. Thus the frequency amplified is equal to the difference between itself and the input frequency, a condition which can be satisfied only if the amplified frequency is exactly one-half the input frequency.

Independent frequency checks of the output of W2XOR show the average carrier frequency to be within 500 cps of the assigned value at all times, and within 50 cps under usual conditions.

#### Staff and Operating Procedure

The schedule of W2XOR, 105 hours per week, calls for the services of three operators working eight hour shifts. The first man goes on the job at eight A.M., gives the transmitting a dusting (clean-up maintenance), followed by a half-hour warm up period before going on the air. All meter readings are made every thirty minutes. Distortion and frequency runs are made, at present, once a day but will eventually be carried out on a once-a-week basis. The antenna is inspected three times a day. At shut-down, all parts from the fuses to the antenna, including tubes, transformers, connectors, capacitors, etc., are felt by the operator to determine whether or not the operating temperature is normal. In general the operating and maintenance procedure is quite similar to that employed in the WOR 50-kw transmitter at Carteret, N. J.

. . .

## Testing Ceramic Capacitors

(Continued from page 29)

must be exercised in the design of this disc, its bearings, contacting means and inner box if a high degree of accuracy is to be obtained. The box must be rigid, the bearings

must be free of lost motion and a positive detent mechanism and an accurate contacting means provided if the disc is to be rotated during the taking of cold or hot readings and returned to duplicate these settings for subsequent readings. The error due to rotating the disc and returning it to the same position was found to be less than  $10^{-4}$   $\mu\mu\text{f}$ . Fastened to the shaft carrying the work disc above is a drive disc, the edge of which is knurled and numbered to indicate the 13 test positions, and which protrudes through a slot below the door in the front panel. This makes it possible to advance any unit to the test position at any time.

#### Design of Oscillator

Unit No. 3 is the oscillator. Great care was exercised in the design and construction of this unit since the accuracy of the test is dependent on the stability of this oscillator. A crystal controlled oscillator was impossible since the frequency must be a function of the capacitance of the unit being tested. Since the frequency of the oscillator is varied over a wide range of values due to the testing of any unit from 10  $\mu\mu\text{f}$  to 1000  $\mu\mu\text{f}$ , the more common means of stabilization are none too satisfactory. Hence, the causes of instability were minimized as much as possible by placing the standard capacitors (used for adjustment to zero beat), the tank inductor and the tube in a temperature controlled oven, and by employing a regulated source of power for the oscillator circuit. A schematic diagram of the circuit is shown in Fig. 8. The temperature inside the oven during a period of two hours varies less than  $\pm 0.05$  degree C. Therefore, the drift due to temperature change is very small and this is reduced again by a compensation which is discussed later.

A voltage regulating tube was used on the plate and screen supply which eliminated drift due to varying anode potentials. Even though the above precautions were taken, a small but objectional drift with line voltage change still existed. This was traced to the change in heater voltage on the oscillator tube. After spending considerable time and thought on how to compensate for this drift, the following idea seemed to be the only logical one to try.



Since the temperature coefficient of small ceramic capacitors is found to be remarkably constant, and since the oscillator drift was positive with respect to voltage change, it was decided to use one of these capacitors having a negative temperature coefficient and place a small resistance heater inside it. The heater could be connected across the heater of the oscillator tube and the capacitor connected across the tank capacitors. This was done and by the selection of the proper values of capacitance, temperature coefficient and resistance of heater, the drift due to change in line voltage was reduced from  $+0.0082 \mu\mu\text{f/volt}$  to  $+0.0004 \mu\mu\text{f/volt}$ . This constitutes an improvement of 20 to one in stability against changes in line voltage and by maintaining the line voltage constant to  $\pm 0.5$  volt, the error introduced from this cause is made negligible.

After the compensation against drift due to line voltage change was made, it seemed desirable to compensate the oscillator oven for drift against temperature. This may seem unnecessary since the temperature is controlled. However, if there is initially a temperature coefficient of  $+0.016 \mu\mu\text{f/degree C.}$  and this is reduced to  $-0.001 \mu\mu\text{f/C.}$ , the actual drift will be reduced to a value equal to that caused by a temperature change of  $1/16$  of the actual temperature variation of  $\pm 0.05$  degree C. or  $\pm 0.0031$  degree C. This is much simpler than attempting to control the actual temperature to  $\pm 0.0031$  degree C. Since the greatest accuracy is required for values of capacitance below  $10 \mu\mu\text{f}$ , the compensations were made in all cases with zero capacitance in the test jigs. The compensations made on the oscillator reduced the combined drift due to voltage and temperature change from  $\pm 0.005 \mu\mu\text{f}$  to  $\pm 0.00025 \mu\mu\text{f}$  or a factor of 20 to 1.

Unit No. 4 is a conventional radio receiver with both the broadcast and the short wave bands available and using an electron ray tube as a tuning indicator. The broadcast band is usually used in routine testing. It is possible, however, to beat a harmonic of the local oscillator against the standard frequency transmissions of the National Bureau of Standards station WWV operating on 5,000 or 10,000 kc by using the short wave bands of the

## Do you know about the TYPE 160-A Q-METER?

WE have replaced the type 100-A Q-Meter with the type 160-A Q-Meter and have built into it numerous features requested by engineers.

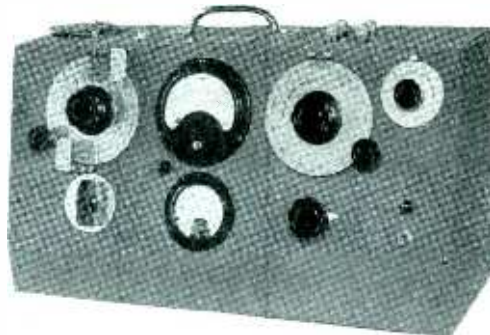

- Frequency Range—50 k.c. to 75 m.c. Also 1 k.c. to 50 k.c. with external oscillator.
- Q Range up to  $Q = 625$ .
- Improved 4" high speed Q Voltmeter.
- Improved Main and Vernier Q Condensers.
- Reduced internal inductance in measuring circuit.
- Availability of oscillator output voltage for general laboratory work.

Your type 100-A Q-Meter can be converted into a type 160-A.

The Q-Meter is the standard instrument of the Radio Industry for the measurement of coils, condensers, dielectrics, antennae, transmission lines, etc.

May we send you detailed information?

**BOONTON RADIO CORPORATION**  
Boonton, New Jersey U. S. A.

## For their AIRLINE TRANSMITTERS

on which human lives must depend, Communications Co. Inc., Coral Gables, Florida used

**JOHNSON**  
CONDENSERS and  
INDUCTORS

This is but one of the many users now depending on Johnson where specifications are exacting. Investigate the advantages Johnson has to offer YOU.

Write for catalog 301D.

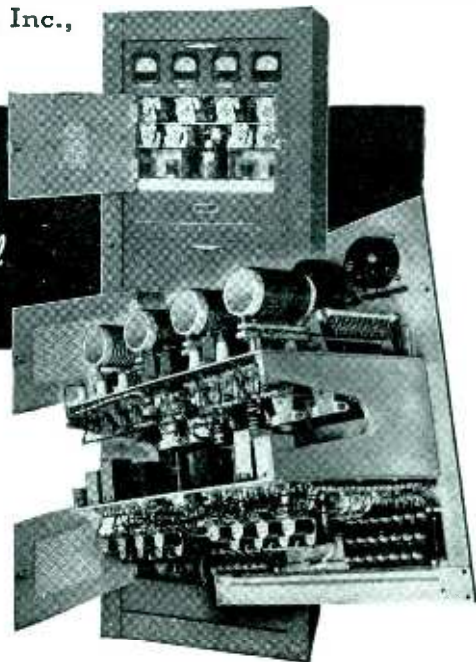

**E. F. JOHNSON CO**

WASECA, MINNESOTA

EXPORT: 23 WARREN ST., NEW YORK, N. Y.

"MANUFACTURERS OF RADIO TRANSMITTING EQUIPMENT"

# ELMET

## MOLYBDENUM TUNGSTEN

and ALLOYS

for the Electronics Industry

### AMERICAN ELECTRO METAL CORPORATION

Research Laboratory and Office: 320 YONKERS AVE., YONKERS, N. Y.

Factory: LEWISTON, MAINE

Cable Address: Cutanit Yonkers NewYork

Telephone: Marble 7-9511

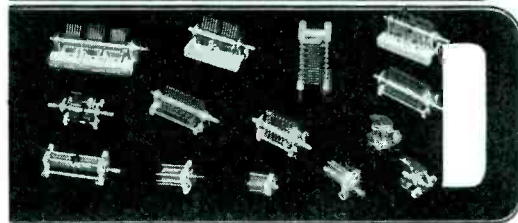
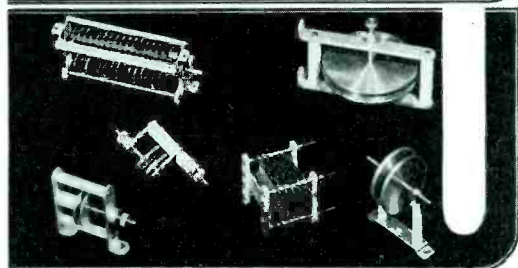
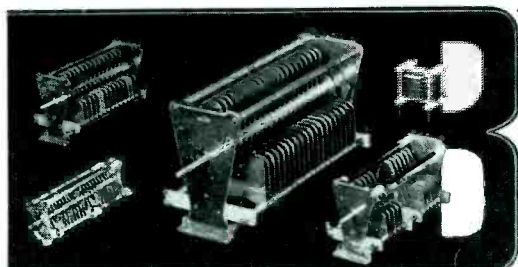

### FOR ALL ELECTRONIC APPLICATIONS

BUD air-dielectric condensers are designed to meet the rigid requirements of constant service in industrial, medical, and laboratory equipment. They are used by manufacturers of diathermy equipment, police, aircraft and commercial transmitters, geo-physical apparatus and a wide variety of similar applications.

Your requirements can be filled from our large stock of 263 different types. Write for your copy of the new BUD catalog, just off the press.



**BUD RADIO, INC.**  
CLEVELAND, OHIO



receiver. The adjustment to zero beat is indicated both aurally and visually. The usual procedure is to reduce the beat note to a few cycles per second using the output of the loud speaker as an indicator and to complete the balance to zero beat using the electron ray tube as an indicator. This method of balance makes possible an adjustment of frequency to better than one part in two million in less than fifteen seconds.

The above description covers the equipment for measuring temperature coefficient of capacitors quite thoroughly except for one point. Provision was made in the work chamber for connecting the units through a jig and shielded line to a bridge for measuring power factor at high and low temperatures and at high and low relative humidities. This jig is located near the left front corner of the work chamber and is visible in Fig. 3. The jig is independent of the one used for measuring capacitance change, which is located in the back part of the chamber. The shielded line, connecting the jig used for measuring power factor to the bridge, may be seen extending between the left side of the work chamber and the bridge in Fig. 1. The equipment is in use daily and has proven entirely satisfactory.

### PENNSYLVANIA'S ATOM SMASHER

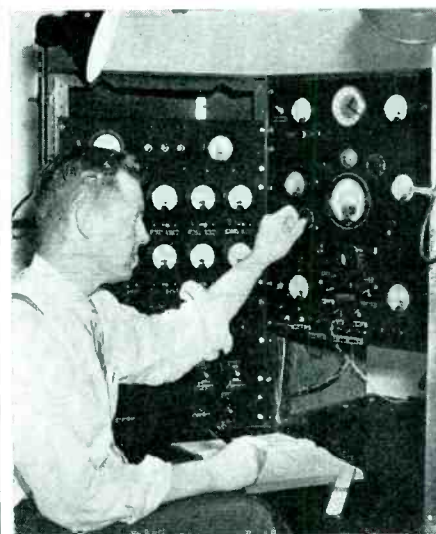

Professor L. N. Ridenour, Jr. of the University of Pennsylvania at the control board of the new 5,000,000-volt electrostatic generator now under construction in the Department of Physics.

## TIME DELAY! SYNCHRONOUS MOTOR DRIVEN

- LOWEST PRICED MOTOR DRIVEN TIME DELAY RELAY
- QUICK VISIBLE DIAL SETTING
- EXTREMELY RUGGED CONSTRUCTION
- SPLIT SECOND ACCURACY
- INSTANTANEOUS AUTOMATIC RESET



Series TD-60 size, mounted in case 5" x 5" x 2 3/4", contact rating 1500 watts non-inductive

LIST  
**\$2000**

Can be furnished for flush or panel mounting

Manufacturers of timers for all purposes . . . catalogue on request

**INDUSTRIAL TIMER CORP.**  
103 Edison Place  
NEWARK, N. J.



M. H. RIETZKE  
PRES. CREI

Our own "coast to coast network" of CREI men in more than

**350 Radio Stations**  
—is proof that  
**CREI training pays!**

Chief engineers want men who possess modern technical training. The fact that men in more than 350 broadcasting stations select CREI training as evidence that our graduates make good. CREI training in Practical Radio and Television Engineering is available in home study and residence courses. Just "ask any engineer" what he thinks of CREI training—and you'll be convinced that we can provide you with the specialized training that leads you to a better job and greater income.

Write for **FREE**  
New illustrated booklet  
"A Tested Plan for  
A Future in Radio"

In our effort to intelligently answer your inquiry—please state briefly your background, education and present position.

**CAPITOL RADIO  
ENGINEERING INSTITUTE**

DEPT. E-9, 3224-16TH ST. N.W., WASH., D. C.



## Modulation Limits in FM

(Continued from page 31)

per cent of the one-half bandwidth, frequencies outside this band will be at least 60 db below the unmodulated carrier. It is necessary to qualify this conclusion when certain percussion instruments such as the triangle and cymbals are present in the program. With these instruments intense peaks occasionally occur<sup>5</sup> at frequencies as high as 10,000 cps. Under these conditions it may be necessary to limit the maximum frequency deviation to 50 per cent of the one-half bandwidth.

It should be pointed out that a small increase in the ratio of the maximum carrier deviation to the one-half bandwidth may result in a large increase of the magnitudes of frequencies outside of the assigned band. For example, an increase of this ratio of from 0.90 to 0.95 results in an increase in the level at the edge of the band of from -75 db to -45 db for a signal frequency of 400 cps.

The principles outlined in this paper appear to offer a reasonable basis for the establishment of modulation limits in a frequency-modulated system. The ratio

$$\frac{\text{maximum frequency deviation}}{\text{one-half bandwidth}}$$

is a convenient means of expressing the maximum permissible degree of modulation. If this limit is properly set, interference in adjacent bands may be avoided.

### REFERENCES

1. Federal Communications Commission, "Rules Governing Broadcast Services Other Than Standard Broadcast," May 23, 1939, p. 20.
2. E. Jahnke and F. Emde, "Tables of Functions With Formulae and Curves," 3rd Ed., B. G. Teubner, Leipzig and Berlin (1938).
3. H. K. Dunn and S. D. White, Statistical Measurements on Conversational Speech, *J. Acous. Soc. Am.* 11, 278 (1940).
4. Harvey Fletcher, Some Physical Characteristics of Speech and Music, *J. Acous. Soc. Am.* Supplement to 3, 23 (1931).
5. L. J. Sivian, H. K. Dunn, and S. D. White, Absolute Amplitudes and Spectre of Certain Musical Instruments and Orchestras, *J. Acous. Soc. Am.* 2, 330 (1931).



## The KEY

. . . . to fit  
your problem

★ The cathode-ray oscillograph has often proved itself just that—the key which unlocks the secrets of circuit operation and circuit troubles, disclosing to the engineer the real cause of his problem.



DuMont cathode-ray instruments are designed with such work in mind. Every one of their outstanding features has been considered with relation to its usefulness in the laboratory. The most recent example of this kind of development work on the part of DuMont engineers is found in the new Type 208 Cathode-Ray Oscillograph. We know you will appreciate its convenience of operation, the care with which its fundamental design was considered in relation to the majority of laboratory problems, and the rare attention to detail which has made this cathode-ray oscillograph perform as perfectly within its specifications as man knows how and the laws of nature will permit.



Either for that particularly perplexing problem which now haunts you, or when considering a piece of general laboratory equipment, it will pay you to stop and investigate this instrument. Detailed information clearly defining the limitations, as well as the advantages, of Type 208 Cathode-Ray Oscillograph, is available upon request.

**DU MONT**

**ALLEN B. DU MONT  
LABORATORIES, Inc.**

Passaic ★ New Jersey

Cable Address: Wespealin, New York

# TUBES

Two extremes are represented in new hearing aid tubes and 1800-watt u-h-f transmitting tubes. Tubes registered with R. M. A. in July, 1940, and early in 1937, are listed this month

## Hearing Aid Tubes

WHENEVER NEW TUBES are announced which are smaller than those previously available, great surprise is often expressed by radio engineers. Then another tube or line of tubes even smaller is announced. The newest candidates for the title of "smallest tube" are two new hearing aid tubes announced by the Raytheon Production Corp. They are both filament pentodes and are designated CK-505 and CK-505X. These employ the same elements with different arrangements for connecting the electrodes to the circuit.



The smallest tubes thus far produced are these units for hearing-aid use

The CK-505 is equipped with a special miniature 5-pin base and the CK-505X has tinned copper leads for soldering directly in the circuit. The latter tube is supplied with a removable standard octal base to facilitate testing. The CK-505 has a seated height of  $1\frac{1}{8}$  inches and the diameter of the glass envelope is 0.550 inch.

A pair of these tubes in a resistance coupled amplifier has a voltage gain of 225 with a plate voltage supply of 30 volts. The total B battery drain for

both tubes is 54 microamperes and the drain on the filament battery is 30 ma at 1.25 volts or 37.5 milliwatts. The filament rating is 0.625 volts at 30 ma. These new tubes were designed especially for use in hearing aids and other applications where extremely small size and low battery drain are of primary importance.

• • •

## U-h-f Transmitting Tubes by General Electric

TWO NEW TRANSMITTING TUBES for use at ultra high frequencies have been introduced by the General Electric Co. They are both triodes and are identical with each other except that one is air cooled and the other is water cooled. The GL-8002R, shown at the right in the accompanying photograph, is equipped with a milled copper radiator for forced-air cooling. The GL-8002 is of the same construction except for the radiator.

These new tubes have been especially designed for use in television and frequency modulation transmitters. Full output of 1800 watts may be achieved at frequencies up to 120 Mc in the air-cooled model and up to 150 Mc in the water-cooled model. Frequencies up to 200 Mc (air-cooled tube) and 300 Mc (water-cooled tube) can



Full output of 1800 watts is available up to 150 Mc in the GL-8002 (left), up to 120 Mc in the air-cooled version

be used if the tube is operated at reduced output. The telegraph ratings are: plate voltage, 3000 v, plate input, 3 kw and plate dissipation, 1.2 kw.

The GL-8002 and GL-8002-R are small considering their power rating. They are  $4\frac{11}{16}$  inches and  $5\frac{3}{8}$  inches long respectively and have maximum diameters of  $1\frac{7}{8}$  inches and  $3\frac{11}{16}$  inches respectively. The inductance of the electrodes is minimized by the use of multiple leads to the filament and grid connectors.

## Tube Registry

Tube Types Registered by R.M.A.  
Data Bureau During July, 1940

### Type 12B6M

DIODE triode, heater type, metal sprayed (T-9) glass envelope, seated height  $3\frac{1}{4}$  inches (max), 6-pin octal base.

$E_h = 12.6$  v  
 $I_h = 0.15$  amp  
 $E_b = 250$  v (max)  
 $E_s = -2$  v  
 $I_b = 0.9$  ma  
 $\mu = 100$   
 $r_p = 91,000$  ohms  
 $g_m = 1,100$   $\mu$ mhos  
 $C_{in} = 2.5$   $\mu$ mf  
 $C_{out} = 7.0$   $\mu$ mf  
 $C_{sp} = 1.7$   $\mu$ mf  
Basing 6Y-1-8

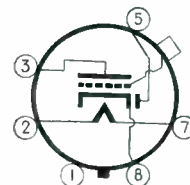

### Type 3LE4 (GL)

POWER amplifier pentode, tapped filament, (T-9) integral glass envelope-base, seated height  $2\frac{1}{4}$  inches (max), 8-pin loktal base.

$E_h = 2.8$  v  
 $I_h = 0.050$  amp  
 $E_b = 90$  v  
 $E_{c2} = 90$  v  
 $E_c = -9$  v  
 $I_b = 9.0$  ma  
 $I_{c2} = 1.8$  ma  
 $r_p = 110,000$  ohms  
 $g_m = 1,600$   $\mu$ mhos  
 $R_i = 8,000$  ohms  
 $P_o = 0.30$  watts  
Basing 6BA-L-0

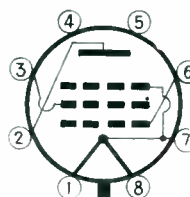

Tube Types Registered By R.M.A.  
Data Bureau in 1937

### Type 6N5

ELECTRON ray indicator tube, heater type, ST-12 glass envelope, seated height  $3\frac{3}{8}$  inches, 6-pin base.

$E_h = 6.3$  v  
 $I_h = 0.15$  amp  
 $E_b = 135$  v  
 $E_{target} = 135$  v  
 $I_{target} = 2$  ma (approx)  
 $E_k$ (shadow angle =  $0^\circ$ ) = -12 v  
 $E_c$ (shadow angle =  $90^\circ$ ) = 0 v  
Basing 6-R

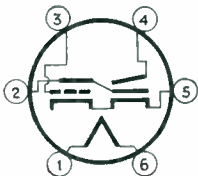

### Type 6S7 (G)

TRIPLE grid, super control pentode, remote cutoff, heater type, ST-12 glass envelope, seated height  $3\frac{3}{8}$  inches, 7-pin octal base.

$E_h = 6.3$  v  
 $I_h = 0.15$  amp  
 $E_b = 250$  v (max)  
 $E_{c2} = 100$  v (max)  
 $E_c = -3.0$  v  
 $I_b = 8.5$  ma  
 $I_{c2} = 2.0$  ma  
 $\mu_m = 1750$   $\mu$ mhos  
 $r_p = 1.0$  megohm  
Basing 7-R

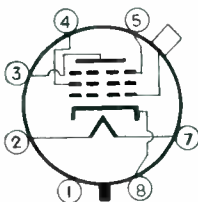

### Type 6Q6 (G)

SINGLE diode high mu triode, heater type, ST-12 glass envelope, seated height  $3\frac{3}{8}$  inches, 6-pin octal base.

$E_h = 6.3$  v  
 $I_h = 0.15$  amp  
 $E_b = 250$  v  
 $E_c = -3.0$  v  
 $I_b = 1.2$  ma  
 $\mu_m = 1050$   $\mu$ mhos  
 $\mu = 65$   
Basing 6-Y



### Type 6B4 (G)

Prototype 6A3

TRIODE power amplifier, filament type, ST-16 glass envelope, seated height  $4\frac{1}{4}$  inches, 8-pin octal base.

$E_f = 6.3$  v  
 $I_f = 1.0$  amp  
 $E_b = 250$  v  
 $E_c = -45$  v  
 $I_b = 60$  ma  
 $R_i = 2500$  ohms  
 $P_o = 3.2$  watts (5%)  
Basing 5-S

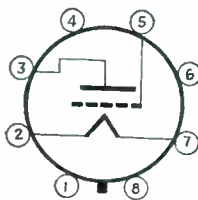

### Type 6K6 (G)

POWER amplifier pentode, heater type, ST-12 glass envelope, seated height  $3\frac{3}{8}$  inches, 7-pin octal base.

$E_h = 6.3$  v  
 $I_h = 0.4$  amp  
 $E_b = 250$  v  
 $E_{c2} = 250$  v  
 $E_c = -18$  v  
 $I_b = 32$  ma  
 $I_{c2} = 5.5$  ma  
 $R_i = 7600$  ohms  
 $P_o = 3.4$  watts (11%)  
Basing 7-S

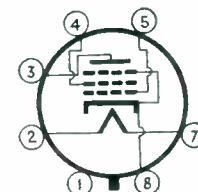

## QUALITY TRANSFORMERS BY FERRANTI

A complete line of stock Audio and Plate-Filament transformers available at moderate cost yet in keeping with "Ferranti Standards of Quality".

Ferranti has specialized in quality transformers for aircraft, marine and numerous other applications where service conditions are abnormally severe.

Special transformers to meet specific requirements for every service. Send us your specifications and let us quote.

Prompt Service — Low Prices — Immediate Delivery on all orders large or small.

Write for complete descriptive literature and prices.



## FERRANTI PRODUCTS

Transformers for every electronic, sound, communication, industrial, and laboratory use — miniature aero transformers for aircraft and portable work — high power plate and filament transformers — filters, equalizers, modulation sets, rectifiers, etc. — electrostatic voltmeters, portable voltmeters, ammeters, phase rotation indicators, special testing equipment, and numerous other instruments.

# Ferranti

## ELECTRIC INCORPORATED

R. C. A. BUILDING, NEW YORK, N. Y.

**APPROVED**

*Leakproof*

**ENAMELED  
MAGNET WIRE**

• Much of the success of this Hudson Wire product is due to a new coating method that gives a smooth, permanently-adherent enameling. Mercury-process tests guarantee perfect uniformity; great tensile strength assures perfect laying even at high winding speeds. Especially adaptable for reduction in coil dimensions without sacrificing electrical values.

Our engineering and design facilities are at your disposal—details and quotations on request.

**HUDSON WIRE COMPANY**  
*Winsted Division*

**WINSTED CONNECTICUT**

**PROGRESS REPORT**  
**ACHESON RESEARCH LABORATORIES**

Subject: The Coating of Highly Polished Sur-  
 faces with "Dag" Colloidal Graphite

Highly polished surfaces cleaned with metallo-  
 graphic powder and water are readily wetted at  
 room temperature by pure water carrying syn-  
 thetic graphite in colloidal dispersion. Sur-  
 faces which have not been cleaned by this means can be suc-  
 cessfully treated with colloidal  
 graphite if they are first heated. Typical relationships follow from  
 Fig. 1, which show suspension  
 concentration plotted against  
 minimum wetting temperature.

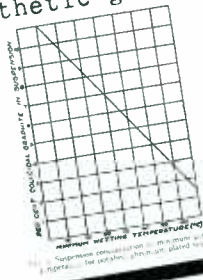

These findings of practical value to workers in ap-  
 plied electronics show how adherent graphite  
 films may be readily formed on polished glass and metal  
 to insure electrical conductivity, dry lubrication, "gettering"  
 and other special properties. The July "Review of Scien-  
 tific Instruments" will carry the above data in augmented  
 form. Write for Technical Bulletins 11, 31, 270.

ACHESON COLLOIDS CORPORATION  
 PORT HURON, MICHIGAN



# FAILURE

## Not Allowed!

This 150 watt, four-channel unit, designed especially for aeronautical use by Communications Equipment Co. of Coral Gables, Florida, again vividly associates the name KENYON with Dependable Operation—for Aviation tolerates no failures.

Today—more than ever—Kenyon is the bulwark upon which the lives and safety of many people depend because Kenyon Transformers are uniformly reliable under even the most adverse conditions.

Ask any manufacturer of quality equipment—whether for commercial, private or governmental use—what they think of Kenyon Transformers. Uniformly the answer will be, "we have 'Kenyonized' to assure dependable performance." They realize the importance of "Failure—not allowed!"

Consult our Engineering Department today. They are at your service!

**NEW CATALOG**

describes and illustrates our complete line of Transformers for every commercial and industrial use.

**KENYON TRANSFORMER CO., INC.**  
 840 Barry St. New York, N. Y.

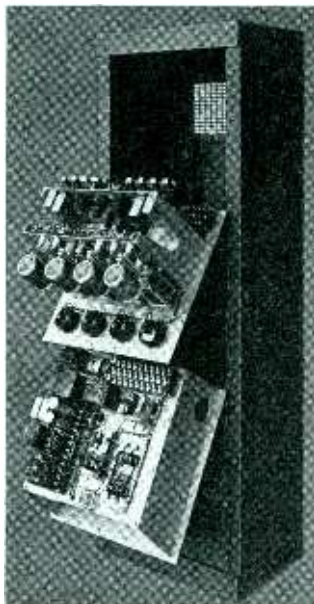

### Type 6L5 (G)

DETECTOR amplifier triode, heater type, ST-12 glass envelope, seated height 3 1/8 inches, 6-pin octal base.

$E_h = 6.3$  v  
 $I_h = 0.15$  amp  
 $E_b = 250$  v  
 $E_c = -9.0$  v  
 $I_b = 8.0$  ma  
 $\phi_m = 1900$   $\mu$ mhos  
 $\mu = 17$   
 Basing 6-Q

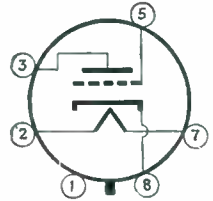

### Type 25B6 (G)

POWER amplifier pentode, heater type, ST-14 glass envelope, seated height 1 1/8 inches, 7-pin octal base.

$E_h = 25.0$  v  
 $I_h = 0.3$  amp  
 $E_b = 200$  v  
 $E_{c2} = 135$  v  
 $E_c = -23$  v  
 $I_b(\text{zero signal}) = 62$  ma  
 $E_{c2}(\text{zero signal}) = 1.8$  ma  
 $R_f = 2500$  ohms  
 $P_o = 7.1$  watts (15%)  
 Basing 7-S

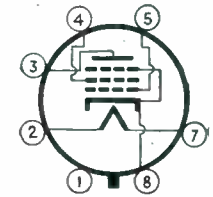

### Type 5U4 (G)

Prototype 5Z3

FULL wave, high vacuum rectifier, filament type, ST-16 glass envelope, seated height 4 1/2 inches, 5-pin octal base.

$E_f = 5.0$  v  
 $I_f = 3.0$  amps  
 CONDENSER INPUT TO FILTER  
 $E_{cc}(\text{per plate, rms}) = 450$  v (max)  
 $I_{dc} = 225$  ma  
 CHOKE INPUT TO FILTER  
 $E_{cc}(\text{per plate, rms}) = 550$  v (max)  
 $I_{dc} = 225$  ma  
 $E_{drop}(I_{dc} = 225$  ma per plate) = 58 v  
 Basing 5-T

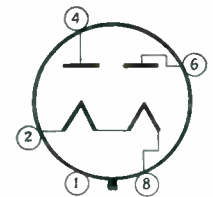

### Type 6B8 (G)

Prototype 6B7

DUODIODE pentode, heater type, ST-12 glass envelope, seated height 3 3/8 inches, 8-pin octal base.

$E_h = 6.3$  v  
 $I_h = 0.3$  amp  
 $E_b = 250$  v  
 $E_{c2} = 125$  v (max)  
 $E_c = -3.0$  v  
 $I_b = 9.0$  ma  
 $I_{c2} = 2.3$  ma  
 $r_p = 0.6$  megohm  
 $\phi_m = 1125$   $\mu$ mhos  
 Basing 8-E

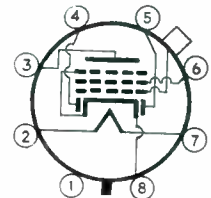

### Type 6N6

Prototype 6B5

DYNAMIC coupled power amplifier, heater type, metal envelope, seated height 3 1/2 inches, 7-pin octal base.

$E_h = 6.3$  v  
 $I_h = 0.8$  amp  
 $E_b(\text{output}) = 300$  v  
 $E_i(\text{input}) = 300$  v  
 $E_c = 0$  v  
 $I_b(\text{output}) = 42$  ma  
 $I_b(\text{input}) = 9$  ma  
 $R_i = 7000$  Ohms  
 $P_o = 4$  watts (5%)  
 Basing 7-W

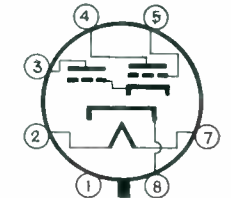

# JAGABI *Lubri-tact* RHEOSTATS

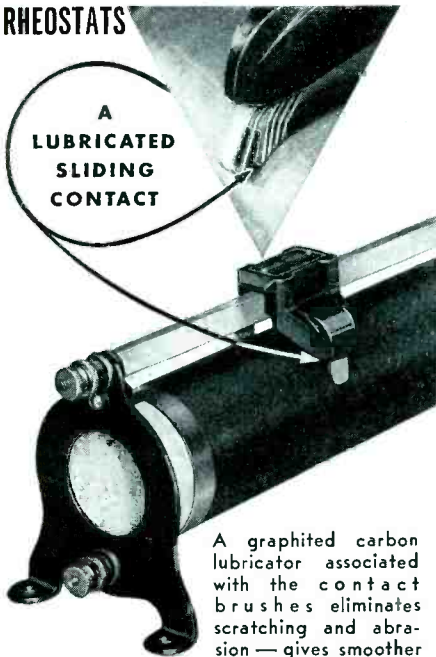

A graphited carbon lubricator associated with the contact brushes eliminates scratching and abrasion — gives smoother operation and a better contact. Makes Jagabi Rheostats better rheostats.

Write for Bulletin 1620-E which lists new lower prices.

**JAMES G. BIDDLE CO.**  
Electrical Instruments  
1211-13 Arch Street Philadelphia, Pa.

## Relays WITHOUT Delays

Your particular needs in signalling and control devices and equipment have already been anticipated and met by Autocall. Thirty years leadership is your assurance of efficiency. Long, economical service is your final proof of it. Write today for new illustrated catalog.

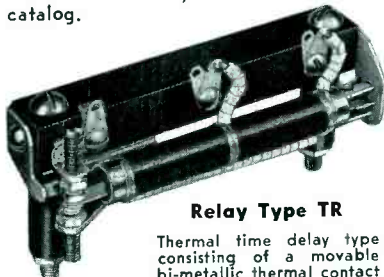

Relay Type TR

Thermal time delay type consisting of a movable bi-metallic thermal contact strip housed within a fixed tubular heating unit. The entire element is mounted on a bakelite block for panel installation. Can be supplied for panel mounting or with jack type base.

**The Autocall Co.**  
SHELBY • OHIO

- RELAYS
- INDICATING DEVICES
- BELLS, HORNS, CHIMES
- and MISC. EQUIPMENT
- TERMINAL DISCONNECT BLOCKS
- ANNUNCIATORS
- LIQUID FLOW DEVICES
- CODING TRANSMITTERS
- SIGNALLING SYSTEMS - ALL TYPES

### Type 25L6 (G)

BEAM power amplifier, heater type (ST-12), glass envelope, seated height  $3\frac{3}{8}$  inches, 7-pin octal base.

$E_A = 25.0$  v  
 $I_A = 0.3$  amp  
 $E_b = 110$  v (max)  
 $E_{c2} = 110$  v (max)  
 $E_c = -7.5$  v  
 $I_b$  (zero signal) = 49 ma  
 $I_{c2}$  (zero signal) = 4.0 ma  
 $R_i = 2000$  ohms  
 $P_o = 2.2$  watts (10%)  
Basing 7-A-C

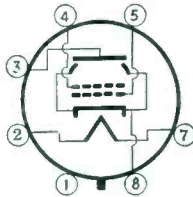

### Type 6D8 (G)

PENTAGRID converter, heater type, ST-12 glass envelope, seated height  $3\frac{3}{8}$  inches, 8-pin octal base.

$E_A = 6.3$  v  
 $I_A = 0.15$  amp  
 $E_b = 250$  v  
 $E_{c1,2} = 100$  v  
 $E_{c2} = 250$  v through 20,000 ohms  
 $E_c = -3$  v  
 $I_b = 3.5$  ma  
 $I_{c2} = 4.3$  ma  
 $I_{c1,2} = 2.6$  ma  
 $\theta_c = 550$   $\mu$ mhos  
Basing 8-A

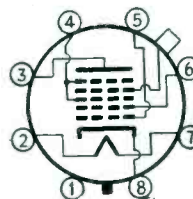

### Type 25A7

POWER amplifier pentode, half-wave rectifier, heater type, ST-14 glass envelope, seated height  $4\frac{7}{8}$  inches, 8-pin octal base.

$E_A = 25.0$  v  
 $I_A = 0.3$  amp  
**PENTODE SECTION**  
 $E_b = 100$  v  
 $E_{c2} = 100$  v  
 $E_c = -15$  v  
 $I_b = 20.5$  ma  
 $I_{c2} = 4$  ma  
 $R_i = 4500$  ohms  
 $P_o = 770$  milliwatts (9%)  
**RECTIFIER SECTION**  
 $E_{ac}(rms) = 125$  v  
 $I_{dc} = 7.9$  ma  
Basing 8-F

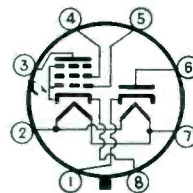

### Type 6B8

DUODIODE pentode, heater type, metal envelope, seated height  $2\frac{1}{8}$  inches, 8-pin octal base.

$E_A = 6.3$  v  
 $I_A = 0.3$  amp  
 $E_b = 250$  v  
 $E_{c2} = 125$  v  
 $E_c = -3.0$  v  
 $I_b = 10$  ma  
 $I_{c2} = 2.3$  ma  
 $r_p = 0.6$  megohm  
 $\theta_m = 1325$   $\mu$ mhos  
Basing 8-E

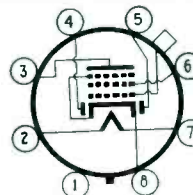

### Type 25B5

DYNAMIC coupled power amplifier, heater type, ST-12 glass envelope, seated height  $3\frac{1}{8}$  inches, 6-pin base. (Similar to 25N6G.)

$E_A = 25.0$  v  
 $I_A = 0.3$  amp  
 $E_b$  (output) = 180 v (max)  
 $E_b$  (input) = 100 v  
 $E_c = 0$  v  
 $I_b$  (output) = 46 ma  
 $I_b$  (input) = 5.8 ma  
 $R_i = 4000$  ohms  
 $P_o = 3.8$  watts (9%)  
Basing 6-D

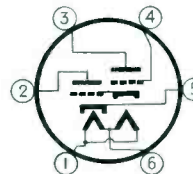

## EVERY SIZE for ANY JOB

Here is the only complete line of "B" power supply equipment for police units, air craft and radio broadcast service and sound systems.

Frames, sizes and capacities to fit any requirements. 5 to 850 watts. Input, 6 to 110 volts; output, up to 1750 volts.

Pincor Dynamometers are the last word in efficiency and regulation. Deliver high voltage current for proper operation of your apparatus with a minimum of A. C. ripple.

Compact, light weight. With or without filter. Send for catalog.

### ROTARY CONVERTERS

Complete line for converting 6, 12, 32, 110 or 220 volts D. C. to 110 or 220 volts A. C. 40 to 3,000 watts.

**PIONEER  
GEN-E-MOTOR CORP.**  
CHICAGO • ILLINOIS

Export Address: 25 Warren St., N.Y., N.Y.  
Cable: Simontrice, New York

PIONEER GEN-E-MOTOR CORP.  
Dept. R-41  
466 W. Superior St., Chicago, Ill.  
Please send information on Pincor Dynamometers, Motor Generators and special power supply units.

Name .....

Address .....

City ..... State .....

Also send me Rotary Converter Catalog.

BY

*Doolittle*

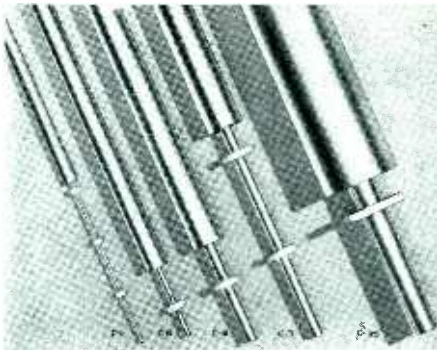

**CONCENTRIC LINE**

Loss and undesirable radiation are eliminated when concentric line is used to connect your transmitter or receiver to the antenna. Seven sizes are available from 3/8" diameter for low power transmitting and receiving up to 3 inch diameter rated at 100KW. Let us know your requirements.

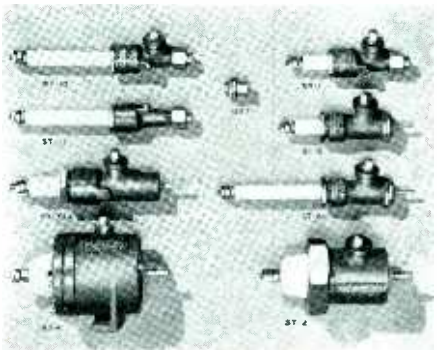

**SEALED TERMINALS**

Obtain the best efficiency from your concentric line installation by filling it with gas. Be sure the gas will not leak out by installing sealed terminals. Sizes are available for any size line or application.

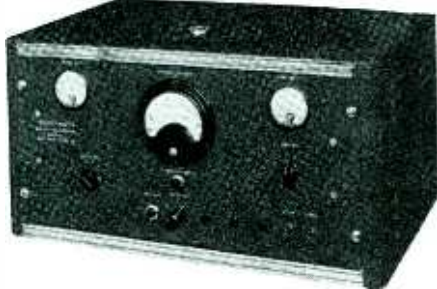

**DIRECT READING FREQUENCY MONITOR**

Simplify your frequency checking by installing an FD-8 Monitor. It reads carrier frequency deviation directly on the precision Frequency Meter on the front panel. Provision is made for operation on six frequencies. Readings are guaranteed accurate within .002% of the carrier frequency.

**OUR LINE INCLUDES**

- POLICE RADIO TRANSMITTERS & RECEIVERS
- BROADCAST TRANSMITTERS
- FIELD INTENSITY METERS
- HIGH FREQUENCY ANTENNAE
- SPECIAL RADIO APPARATUS TO SPECIFICATIONS

• Literature and Prices Sent on Request

**DOOLITTLE RADIO INC.**  
7421-23 Loomis Blvd. Chicago, Ill.

**Type 25N6 (G)**

DYNAMIC coupled power amplifier, heater type, ST-12 glass envelope, seated height 3 1/8 inches, 7-pin octal base. (Similar to 25B5.)

$E_k = 25.0 \text{ v}$   
 $I_k = 0.3 \text{ amp}$   
 $E_b(\text{output}) = 180 \text{ v}$   
 (max)  
 $E_b(\text{input}) = 100 \text{ v}$   
 $E_c = 0 \text{ v}$   
 $I_b(\text{output}) = 46 \text{ ma}$   
 $I_b(\text{input}) = 5.8 \text{ ma}$   
 $R_i = 4090 \text{ ohms}$   
 $P_o = 3.8 \text{ watts (9\%)}$   
 Basing 7-W

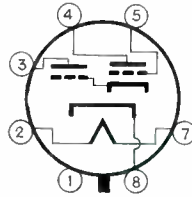

**Type 6V7 (G)**

DUODIODE triode, heater type, ST-12 glass envelope, seated height 3 1/8 inches, 7-pin octal base.

$E_k = 6.3 \text{ v}$   
 $I_k = 0.3 \text{ amp}$   
 $E_b = 250 \text{ v}$   
 $E_c = -20.0 \text{ v}$   
 $I_b = 8.0 \text{ ma}$   
 $r_p = 7500 \text{ ohms}$   
 $\mu_m = 1100 \text{ }\mu\text{mbos}$   
 $R_i = 20,000 \text{ ohms}$   
 $P_o = 350 \text{ milliwatts}$   
 Basing 7-V

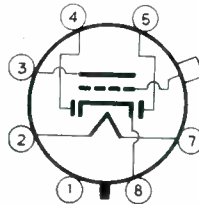

**Type 6U7 (G)**

Prototype 6D6

TRIPLE-GRID super-control amplifier, remote cutoff, heater type, ST-12 glass envelope, seated height 4 1/8 inches, 7-pin octal base.

$E_k = 6.3 \text{ v}$   
 $I_k = 0.3 \text{ amp}$   
 $E_b = 250 \text{ v (max)}$   
 $E_c = 100 \text{ v}$   
 $E_c = -3.0 \text{ v}$   
 $I_b = 8.2 \text{ ma}$   
 $I_c = 2.0 \text{ ma}$   
 $r_p = 0.8 \text{ megohm}$   
 $\mu_m = 1600 \text{ }\mu\text{mbos}$   
 Basing 7-R

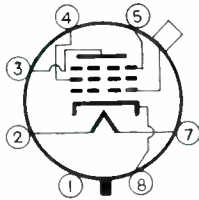

**OUT-DETECTING THE LIE-DETECTOR**



The "psychometer" developed at the University of Iowa measures the emotional reaction of a patient by measuring changes in the sweat glands. It is claimed by the inventor Christian Rucknick to be more accurate than the conventional lie detectors which measure changes in blood pressure, respiration and temperature

Precision Built  
for Perfect Performance...

**FAIRCHILD**  
TRANSCRIPTION TURNTABLE  
for Wow-Free Reproduction

Precision construction insures higher-fidelity reproduction — and this Fairchild Unit 227 eliminates wow, speed variations, and vibration.

Dynamically balanced 16-lb. cast-iron turntable is driven by synchronous motor through two-speed adhesion drive. Fairchild floating motor assembly eliminates objectionable motor vibration.

...it had to satisfy Fairchild first™

**FAIRCHILD**  
Sound Equipment Division  
AVIATION CORPORATION  
88-06 Van Wyck Boulevard, Jamaica, L. I., N. Y.

**NEW TERMINALS**  
*With Wide Range Utility*

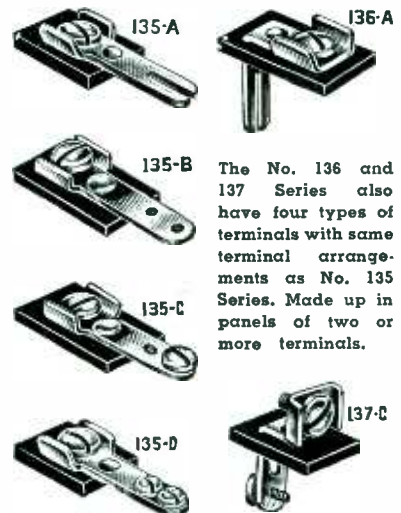

The No. 136 and 137 Series also have four types of terminals with same terminal arrangements as No. 135 Series. Made up in panels of two or more terminals.

Our line of standard parts is constantly being increased to give you the most complete service for Terminal Panels, Terminals, Plugs, Sockets, etc. Specials also made to your blue print. Write for new catalog today. Address Dept. 10.

**HOWARD B. JONES**  
2300 WABANSIA AVENUE,  
CHICAGO ILLINOIS



## Type 5Y4 (G)

Prototype 80

FULL wave high vacuum rectifier, filament type, ST-14 glass envelope, seated height  $4\frac{1}{8}$  inches, 8-pin octal base.

$E_f = 5.0$  v  
 $I_f = 2.0$  amp  
 CONDENSER INPUT TO FILTER  
 $E_{ac}$ (per plate, rms) = 350 v (max)  
 $I_{dc} = 125$  ma  
 CHOKE INPUT TO FILTER  
 $E_{ac}$ (per plate, rms) = 500 v (max)  
 $I_{dc} = 125$  ma  
 $E_{drop}(I_{dc} = 125$  per plate) = 60 v  
 Basing 5-Q

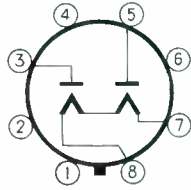

## Type 5X4 (G)

Prototype 5Z3

FULL wave high vacuum rectifier, filament type, ST-16 glass envelope, seated height  $4\frac{3}{4}$  inches, 8-pin octal base.

$E_f = 5.0$  v  
 $I_f = 3.0$  amps  
 CONDENSER INPUT TO FILTER  
 $E_{ac}$ (per plate, rms) = 450 v  
 $I_{dc} = 225$  ma (max)  
 CHOKE INPUT TO FILTER  
 $E_{ac}$ (per plate, rms) = 550 v (max)  
 $I_{dc} = 225$  ma (max)  
 $E_{drop}(I_{dc} = 225$  ma per plate) = 58 v  
 Basing 5-Q

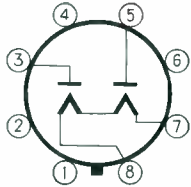

## ELECTRONIC MUSIC FOR PIANISTS



A new electronic musical instrument, the Solovox, which uses vacuum tube oscillators as tone generators, is intended for attachment to the standard piano keyboard. Three octaves (36 keys) are provided, and 12 timbre controls which introduce changes in tone, tonal attack and register vibrato. Anyone who can play the piano can play the solovox simply by playing the treble parts on the auxiliary keyboard

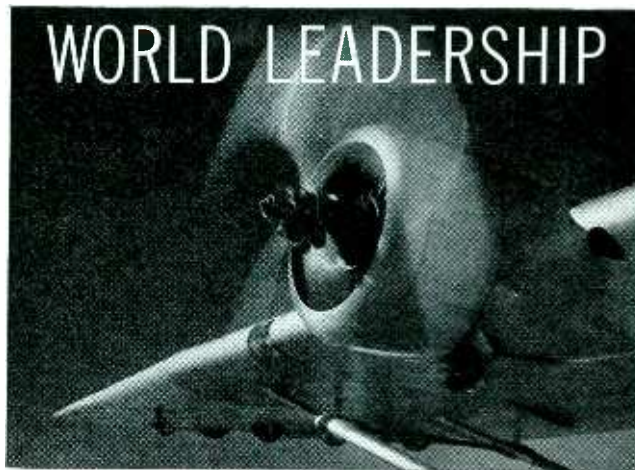

## Bendix-Scintilla relies on WILCO AERALLY!

Matchless performance! Absolute dependability! That's why you find WILCO AERALLY CONTACT POINTS in Bendix-Scintilla Aircraft Magnets—the preferred magneto in every type of aircraft.

Yet in the far-famed WILCO laboratories men of vision, integrity and experience continue to pioneer—so WILCO

contact points, already peerless . . . may be *even better!*

Call on WILCO leadership for the solution of your contact or thermostatic bi-metal problem. Write for "Wilco Blue Book of Thermometals and Electrical Contacts."

**The H. A. Wilson Co.**  
 105 Chestnut St., Newark, N. J.  
 Br. Off.: Detroit, Mich. & Chicago, Ill.

**WILCO ELECTRICAL CONTACTS**

PLATINUM . . . SILVER . . . SPECIAL ALLOYS . . . TUNGSTEN

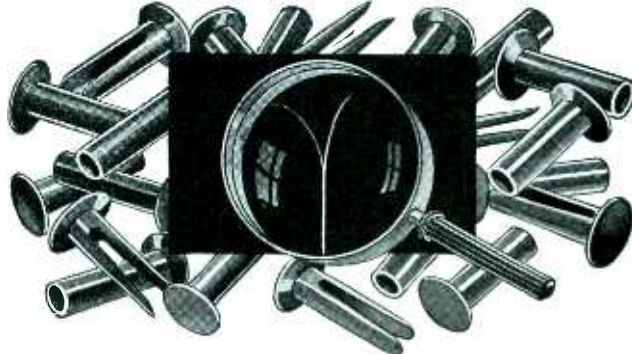

## INSURE COMPLETE SATISFACTION!

Rivets are small—but mighty important! Make sure you always use the best—T R & S Rivets. The superiority of T R & S Rivets is unquestioned. They are specified wherever quality in production is a factor, where standards of fit for stress and strain must be maintained. Such production charts call for rivets of uniform preciseness.

Many motorized models of our rivet setting machines are available in single stroke and multiple drive. Inquiries are invited with samples of work you wish to do.

## TUBULAR RIVET & STUD CO.

*World's Largest Manufacturers of Tubular and Split Rivets*

WOLLASTON (Boston)

MASSACHUSETTS

New York

Chicago

Detroit

Indianapolis

San Francisco

Nashville

Dallas

St. Louis

# THE ELECTRON ART

Topics in the technical literature reviewed this month include an electronic micrometer, tube life tests, feedback in amplifiers, a stable d-c a-c amplifier and a c-r oscillograph used for measuring time intervals

## Electronic Micrometer and Its Use in Mechanical Measurements

THERE APPEARS IN THE June 1940 issue of the *Journal of Applied Mechanics* an article by Ross Gunn describing an electronic micrometer of novel design. This instrument may be used with special circuits which are described to obtain an indication of the sums, differences, ratios, or products of mechanical displacements. Hence, it is useful in many mechanical measurements. The zero drift, hysteresis, temperature and pressure variations have been reduced to less than 1 per cent.

The tube element of this micrometer serves as the connecting link between the mechanical quantities to be measured and the resulting electrical current or potential as shown in the accompanying diagram. It consists of a fixed filament and a pair of anodes insulated from each other and placed on each side of the filament. They are so arranged that they may be moved by means of the supporting rod from the outside. Any motion of the rod is transferred to the anodes of the tube, one of which is moved closer to the filament and the other is moved further away. This changes the resistance of each diode. These changes in resistance are used to give an indication in the exterior circuit. The tube is designed to have high mechanical rigidity and a high natural period of oscillation. A suitable bridge circuit for use with this micrometer is shown in the figure.

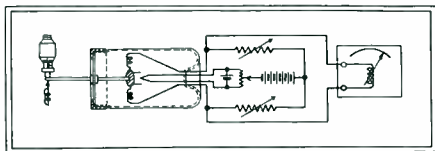

Electronic micrometer using a movable-anode structure

The sensitivity of typical micrometers of this type approximate 150 microamperes per mil (0.001 in.) or about  $\frac{1}{2}$  volt per mil when working into a high impedance. Because of the inherent zero stability built into the tubes and associated circuits, this

micrometer is especially suitable for the measurement or indication of small displacements at a remote point. These small displacements may originate as a result of tension, compression or torsion in some stressed member.

Hence, if the member is elastic and obeys Hooke's law, the indicating electrical meter may be calibrated in terms of strain, stress, force or torque. If a small mass is attached to the anode supporting arm of the tube, the instrument becomes an accelerometer which is readily calibrated in absolute units.

This instrument is also useful for the analysis of low-frequency vibrations. It will follow mechanical vibrations up to more than 65 cps and reproduce the amplitude and wave form on an oscillograph. By careful design the frequency can be raised to about 1,000 cps. The article includes a brief discussion of the many possible measure-

ments which may be made with this new instrument, which because of its simplicity, linearity and stability is a most convenient measuring device.

• • •

## Average Life of Vacuum Tubes

"DETERMINATION OF THE AVERAGE LIFE OF Vacuum Tubes," by D. K. Gannett, appears in the August 1940 issue of the *Bell Laboratories Record*. The method used is similar to that used by the life insurance companies for determining the life expectancy of people. However, the engineer is not as fortunate as the life insurance actuary because he is not able to obtain data from all the individuals concerned. Therefore, he relies on field trials or studies of selected groups of tubes. Furthermore, the tubes used in a telephone plant have average lives which are measurable in terms of years so that a long time would be required to obtain a complete history. Naturally the engineer cannot afford to wait very long to determine whether a certain type of tube is satisfactory for standard use. A method was developed, therefore, by which the average life could be predicted in a comparatively short time.

A certain definite pattern in the life statistics of vacuum tubes as they are now constructed has been found to exist. It has been found in each case in which sufficient data has been obtained to establish the facts. Among a large group of tubes after an initial period that varies with the type of

## GUN WELDERS



Electronically controlled spot welders in the shape of guns are now widely used to assemble automobile bodies. The operator pulls a trigger which starts a series of accurately timed current pulses. An operator may join 20 parts in 150 places in less than a minute on this jig for a radiator and grille assembly

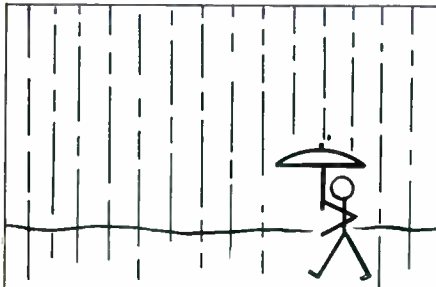

"Save your money for a rainy day."

There is no saving in using questionable resistors.

Use a resistor specifically designed to do the job in hand.

Let us help you in the selection of the proper resistor for your purpose.

Catalogue upon Request

**Instrument Resistors, Inc.**  
LITTLE FALLS, NEW JERSEY  
MAKERS OF WIRE-WOUND RESISTORS  
FOR THE ELECTRONIC INDUSTRY

## New LITTELFUSE Catalog

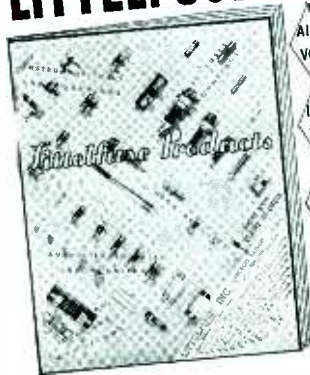

- AIRCRAFT & HIGH-VOLTAGE FUSES
- INSTRUMENT FUSES
- FUSE MOUNTINGS
- VIDEO and SLO-BLO FUSES
- FUSES for RADIO, TRANSFORMERS, AMPLIFIERS, etc.

Gives you a better understanding of how and when to use Littelfuses!

In these 12 pages you will find most essential engineering data, charts, curves—with a complete listing of Littelfuses, fuse mountings and other products—information that you will want. Be sure to get your copy. A request on your letterhead will bring the catalog to your desk free.

**LITTELFUSE INC.**  
4755 RAVENSWOOD AVE. CHICAGO, ILL.

tube, the rate of failure expressed in per cent of the tubes remaining in service tends to become constant just as though random failure occurred. Thus, the curve showing the per cent of a group of tubes remaining in service plotted against the time after they are placed in service becomes approximately an exponential curve after an initial period has passed. Such a curve becomes a straight line when plotted on semi-logarithmic coordinates. When enough data of a test has been obtained to determine such a straight line, it may be reasonably assumed that that straight line will indicate the rate of failure of the tubes.

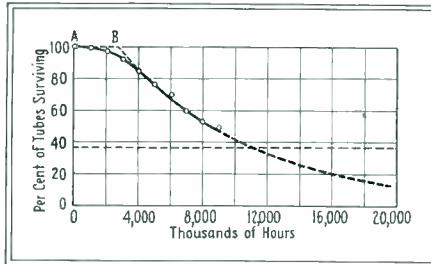

Tube life statistics. The horizontal dotted line represents average life

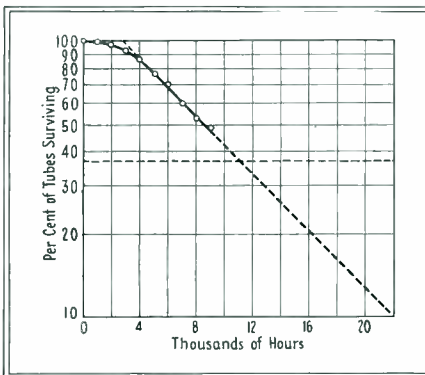

Life curve plotted on log coordinates to show exponential law

The average life of a group of tubes is the total number of tube hours of service which they render divided by the number of tubes originally in the group. If the life curve is exactly exponential throughout, it can be shown that the average life corresponds to the time when about 37 per cent (100 per cent divided by  $e$ ) of the tubes remain in service.

There is little advantage to a system of maintenance if all tubes are periodically replaced by new tubes. This is because the short-lived tubes have already been weeded out and the tubes that remain are likely to last as long and give as good service as the new tubes with which they might be replaced.

• • •

### Feedback Amplifiers

FEEDBACK AS APPLIED TO AMPLIFIERS comes in for discussion in current technical periodicals. There appears



## NEW PRECISION PORTABLES



**Model 625**  
Clear Readability

Models 625 (DC—Moving Coil Type)—635 (AC—Movable Iron Vane Type) and 665 (Electrodynamometer Type) . . . new molded case portables, may be obtained with extreme sensitivity for laboratory use—as well as those for general commercial and industrial testing purposes. Have mirror scale and knife-edge pointer to assure quick, accurate readings. Scale length is 4.58"—Accuracy within 1%. Attractive black molded case, 6" x 5½" x 2½". Attached leather strap handle.

### Model 725

Another popular line of portables includes Models 725 (DC)—735 (AC). This popular style has a precision instrument with long 6" mirror scale. Oak case is 11" x 9" x 4".

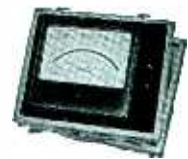

### Model 626

Another of the new panel instrument case styles being added constantly to the Triplet line. This 6" rectangular molded case instrument offers unusually long readable scales—5.60" DC; 5.30" AC—One of Triplet's 25 case styles.



Write for Catalog—Section 239  
Harmon Drive

**THE TRIPLET ELECTRICAL INSTRUMENT CO.**  
Bluffton, Ohio

**Full Size** **Accurate**  
**Easy Reading**

**PRECISION**  
**INDUSTRIAL TESTERS**

**Portable** **Rugged**



**Series J**  
**A NEW**  
**full size**  
**multi-range**  
**A. C.**  
**AMMETER**  
**for all line**  
**frequencies**  
**25 to 60**  
**cycles**

• 8 Ranges to 60 AMPERES: 0-300-600-1200 Milliampere; 0-3-6-12-30-60 Amperes. All ranges terminate at INDIVIDUAL 3/4" heavy duty bakelite insulated binding posts. • Extra large 4 1/2" meter—2% accurate—wide window opening and large scale numerals for rapid easy reading. • Direct Reading on 25 to 60 cycles lines by use of a specially designed, over-size current transformer. • Ideal for the laboratory, production line, maintenance department and repair shop—motors, radio receivers and transmitters, electrical appliances, refrigeration, air conditioning, etc.

Series "T" (Illustrated) in hardwood portable case with tool compartment and removable hinged cover. Size 9 x 10 x 6. Net Price **\$19.95**

Series "T" L in open type hardwood portable case. Size 7 1/2 x 8 1/2 x 4. Net Price **\$17.95**



**Series 844J—A New All-Purpose**  
**AC-DC INDUSTRIAL CIRCUIT TESTER**

Combining the well-known PRECISION Series 844 . . . 34 range AC-DC volt-ohm-decibel-milliammeter-ammeter and the new Series "J" (8 range AC Ammeter) in one compact portable unit.

• 6 AC and 6 DC voltage ranges to 6000 volts at 1000 ohms/volt. • 6 DC current ranges from 0 to 1.2 MA to 0-12 AMPERES. • 4 internally powered resistance ranges to 10 MEGOHMS. • 6 DB ranges from -12 to 70 DB. • 6 output ranges to 6000 volts. • 8 AC Ammeter ranges from 0-300 MA to 0-60 AMPERES.

An unsurpassed combination portable instrument to satisfy industrial requirements for complete AC and DC circuit analysis.

Series 844J (Illustrated) in hardwood portable case with dual tool compartment and removable hinged cover—complete with batteries and extra high voltage test leads. Net Price **\$44.95**

Write for the new "PRECISION" 1941 Catalog describing more than 40 test equipment models.

**PRECISION TEST EQUIPMENT**  
Standard of Accuracy SEE THEM AT YOUR JUBBER

**PRECISION APPARATUS COMPANY**  
647 Kent Avenue Brooklyn, New York  
Export Div.: 458 Broadway, New York, U. S. A.  
Cables: Morhanex

in the July 1940 issue of the *Bell System Technical Journal* an article by H. W. Bode, entitled "Relation Between Attenuation and Phase in Feedback Amplifier Design." E. K. Sandeman is the author of another article on feedback in the August 1940 issue of *The Wireless Engineer*. It is stated in Mr. Bode's article that improvements in the characteristics of the amplifier are promised by the application of feedback. But unless the phase and attenuation characteristics around the feedback loop can be properly adjusted so that the amplifier will not spontaneously burst into uncontrollable singing, none of these advantages can actually be realized. Typical designs of feedback loops remind the author of a perpetual motion machine. They both always work except for one little detail. In an effort to avoid attacking the problem blindly, the author developed several mathematical relations which in their sphere have the same inviolable character as the physical law which forbids the building of perpetual motion machine. They show that the attempt to build amplifiers with certain types of loop characteristics must fail. They permit other types of characteristic but only at the cost of certain consequences which can be calculated.

In Mr. Sandeman's article the problem of feedback is attacked from a more general viewpoint. An ideal case of feedback is first discussed to develop the fundamental formulas. This is followed by two more practical examples. The various factors influencing the design of feedback amplifiers are considered in detail. The engineer making use of feedback amplifiers would do well to read this article as well as the one written by Mr. Bode.

• • •

### ONE EEL-POWER



An electric eel (left of center) at the World's Fair exhibit of the New York Zoological Society is used to actuate a relay which puts into operation a telegraph printer. A perforated tape sends the message



**A**S business paper publishers for over 50 years, McGraw-Hill is uniquely equipped to offer complete, authoritative direct mail coverage of Industry's major markets. Extreme accuracy is maintained (guaranteed to 98%) and through careful analysis of markets, complete classification of companies and personnel, etc., the widest possible selections are available. Send for handy reference folder "Hundreds of Thousands of Reasons Why" which describes how McGraw-Hill Lists are built and maintained.

### What Fields Do You Want to Reach?

- Aviation Industry
- Bus & Transit Industries
- Business Executives
- Chemical Process Industries
- Civil Engineering & Construction
- Coal Mining
- Electrical Appliance Dealers
- Electrical Contractors
- Electrical Industry
- Electrical Wholesalers
- Food Industries
- Manufacturing Industries
- Metal Mining
- Metal Working Industries
- Mill Supply Distributors
- Power Engineers
- Product Engineers
- Radio Dealers & Wholesalers
- Radio Engineers
- Textile Industries

For further details, selections from above basic classifications, counts, prices, etc., or estimates on special lists . . . ask any representative or write to



. . . Complete Lists Covering Industry's Major Markets

## Balanced D-C Amplifier for A-C Operation

A D-C AMPLIFIER SUITABLE FOR PRECISION measurements and operation from an alternating current power line is described by R. Stair and I. F. Hand in the August 1940 issue of the *Review of Scientific Instruments*. It was originally designed for use by the U. S. Weather Bureau in the study of ultra-

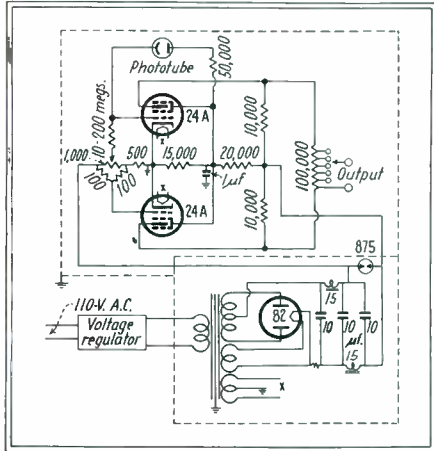

Diagram of bridge-type balanced amplifier

violet solar radiation and the determination of the amount and variation of ozone in the stratosphere. Other engineers may find such an instrument as this useful in their own work. The circuit is shown in the accompanying diagram. To those who wish to build this amplifier it will be well worth while to refer to the article mentioned.

## HIGH VOLTAGE OSCILLOGRAPH



This elaborate oscillograph is used for high voltage studies in the new laboratories of the Bureau of Standards in Washington. Records are made by enclosing a photographic film in the vacuum and allowing the electron beam to trace its path directly on the emulsion

# COILS

Electrical



Windings



A COMPETENT and experienced organization devoted to the design and manufacture of coil windings.

Paper interlayer sections—form wound and bobbin wound coils.

Equipped for prompt production on quantity or small orders.

### REPRESENTATIVES

W. A. JORDAN  
295 Madison Ave., New York, N. Y.

GILBERT GISLASON  
82 St. Paul St., Rochester, N. Y.

PARAGON SALES CO.  
(C. H. Fryburg)  
402 Cherry St., Philadelphia, Pa.  
A. J. LOEB SALES CO.  
1836 Euclid Ave., Cleveland, Ohio

**MAGNETIC WINDINGS COMPANY**  
Sixteenth and Butler Streets EASTON, PENNA.

## STABILIZED A. C. VOLTAGE UP TO 25 KVA

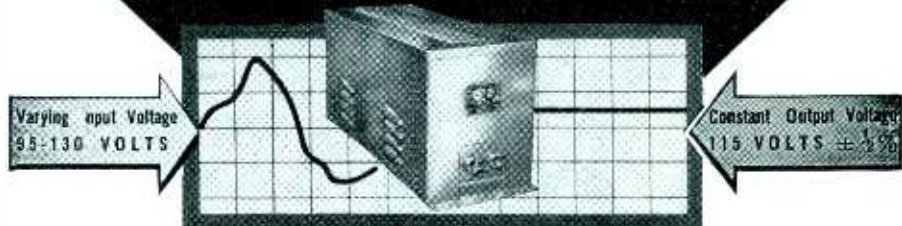

INSTANTANEOUS ACTION

NO MOVING PARTS

When a precision electrical device or a critical process is powered from an AC line, a Raytheon Voltage Stabilizer will permanently eliminate all of the detrimental effects caused by AC line voltage fluctuations. Made for all commercial voltages and frequencies, single or three phase.

Raytheon's twelve years of experience in successfully applying the Stabilizer to hundreds of perplexing voltage fluctuation problems is at your service. It will pay you to take advantage of our engineering skill.

Write for Bulletin DL48-71 JE describing Raytheon Stabilizers.

**RAYTHEON MANUFACTURING CO.**  
100 Willow Street, WALTHAM, Massachusetts

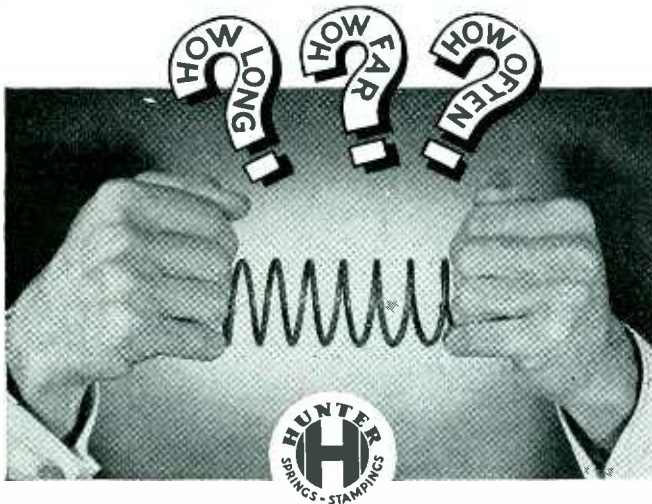

How long should it be? How far should it move? How often must it flex? How strong? What loads? What forces are required? These are a few of the simpler of the hundred odd considerations that make a good spring to do your job right. Accurate choice makes a vital difference to spring life—hence to the life and satisfactory performance of your product.

You'll be safer if you let us check your spring designs. We're specialists. We have the equipment. And a regular Hunter service is test and analysis of springs—to find exactly the one best suited to do the specific job. Often we are able to cut costs while improving the spring; always we can predetermine spring performance—fit the spring to the job. No charge or obligation; consult us freely.



» » »

HUNTER PRESSED STEEL CO., LANSDALE, PA.

# KURMAN PRECISE

RELAYS ARE DEPENDABLE

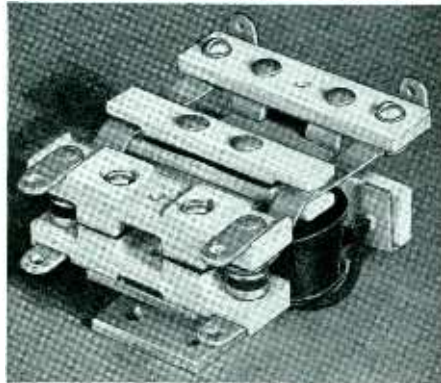

Weights only  
4 ounces.  
A simag  
insulation.

There's no weak spot in a Kurman precision control relay. Every phase of construction is carefully checked—chemical analysis of magnetic material, heat

treatment of magnet frame, coil winding and assembly—and finally before each relay leaves the assembly line it is carefully tested and inspected.

**KURMAN ELECTRIC CO., Inc., 241 LAFAYETTE ST., NEW YORK**

## Cathode-Ray Oscillograph Used As a Time Indicator

TIME INTERVALS OF SHORT DURATION may be measured with an accuracy well under 0.1 millisecond by the use of a standard oscillograph with no auxiliary equipment other than an ordinary still camera and a few inexpensive circuit components. The method is described by H. D. Brailsford in the June-July 1940 issue of *DuMont Oscillographer*.

If two sine voltages of identical frequency and amplitude but with a phase difference of 90 degrees are applied to the vertical and horizontal pairs of deflection plates of a cathode-ray tube, the spot orbit will be a theoretically perfect circle. The spot will have a uniform rate of rotation and will make one complete revolution for each cycle of the deflecting voltages. A phase-splitting circuit is used to develop a circular pattern. The resistance  $R$  must be equal to the reactance  $C$  at the frequency used. If a switch is inserted so as to short circuit the resistance  $R$  there is no vertical deflection of the spot and it oscillates in a horizontal path. If the switch is normally closed and is opened during the time interval to be measured the resultant pattern will be a horizontal straight line plus an arc of a circle which is determined by the time the switch is opened. The time interval is determined by the angle of the arc and the frequency of the voltages used. If 60-cps voltages are used the spot will travel in a complete circle in  $1/60$  of a second and an arc of 21.60 degrees corresponds to 1 millisecond.

## AIRPLANE TIMER



This photoelectric timing device, invented by L. S. Wait, a test pilot, measures the speed of planes by timing the interval between the interruption of the light entering two phototubes. The apparatus is intended to replace the older method of timing a flight over a measured course with a stopwatch.

## MICROMETER FREQUENCY METER



... a band-spread, AC-operated, heterodyne meter; ONE instrument to check several transmitters, 1.5 to 56 mc.

- **RATIO-COUPLED OSCILLATOR:** stability 5 to 10 times that of usual circuits; temperature coefficient less than 2 cycles/10°/°C.; line voltage effect 1 cycle per million for 1% change.
- **MICROMETER CONDENSER:** rugged cylinder-and-tube construction on regular micrometer head—no flimsy plates.
- **PRECISION DIAL:** rotates micrometer head, has 50-turn range and Vocoder counter, reads to 10,000 divisions.
- **PER CENT DEVIATION CURVES:** results readily compared with FCC tolerances.

—Write today for data—



**LAMPKIN**  
LABORATORIES  
BRADENTON . . . FLORIDA

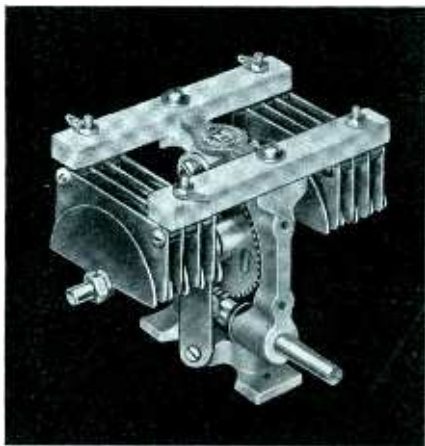

## Designed for Application

Outstanding features of the MILLEN transmitting condensers include: rugged cast aluminum frame, right angle self locking worm drive, center fed rotors and stators, heavy round-edge polished aluminum plates, and genuine Isolantite dielectric. Available in capacities of 35, 50, and 70 mmfd per section with peak break down voltage rating of 3000.

Catalogue Upon Request

JAMES MILLEN MFG. CO. INC.  
150 EXCHANGE ST. MALDEN, MASS.

## The Photoelectric Control of Paper Registration

WHEN PACKAGES ARE WRAPPED with a printed label it is necessary that the label be in the same relative position on each package. In high speed wrapping machinery this becomes a serious problem. Even at low speed it is difficult for an operator to make the adjustment for registration manually. However, it is a fairly simple operation for a photoelectric register control device. Such a device is described by E. W. Forster in the August 1940 issue of *Electronics and Television & Short-Wave World*.

The operation of the photoelectric register control is as follows: The wrapping paper is supplied in previously printed rolls. An opaque register mark about  $\frac{1}{2} \times \frac{1}{4}$  inch is printed at a certain definite location on each label. As the paper passes into the machine it passes through a light beam which is interrupted each time the register mark intercepts it. The paper continues on to a point where it is cut by a rotary cutter and into that portion of the machine where the actual wrapping operation is performed. If the paper is in the proper position for cutting, nothing happens as the register mark passes through the beam. If, however, it is a little too far along the increase in current through the phototube is passed on to a thyatron relay which operates the mechanism to slow down the paper slightly. If the paper is a little too late for correct cutting, the increase of current in the photo tube this time operates another thyatron relay which controls a mechanism to increase the speed of the paper.

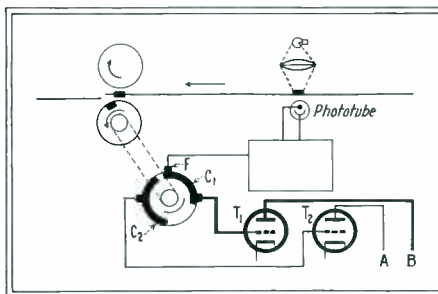

Simplified diagram of photoelectric register control

It is necessary in the operation of such a register control that in addition to a space change to the paper to bring it back into register a small permanent speed change must also be made. If this were not so it is conceivable that the rate of continuation of error may be greater than the speed at which corrections may be made since there is a definite limit not only to the amount of space change per correction, but also the permissible number of corrections per minute. Also if a speed change only is made, then the machine will never settle down to a steady speed but will hunt. The mechanical equipment necessary to the essential operation of this device is also described.

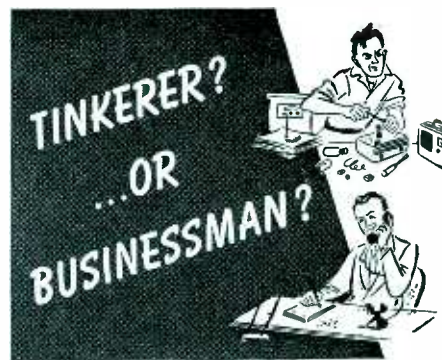

LESS Time to Repair Radios ...  
Means MORE Time to Build Business!

## RCA RIDER CHANALYST



Yesterday's servicing methods were good enough . . . for yesterday. But progressive servicemen today demand methods that fix sets quicker. They spend less time bending over receivers—more time going out after business... developing business-getting ideas . . . building their business.

Signal-tracing with the Rider Chanalyst takes less time!

Greatest advance in radio servicing instruments since servicing began, the RCA Rider Chanalyst uses the newest method of attack: *the signal itself*, common to every radio. It's an investment worth investigating! Ask your RCA Distributor for on-the-circuit proof of the Chanalyst's effectiveness by means of the Dynamic Demonstrator.

"Line 'em up" Faster, Easier, Better!  
NEW RCA A. C. TEST OSCILLATOR  
No. 167 . . . \$34.50 to servicemen

- ★ New, Accurate, Easy-Reading Dial
- ★ 100-30,000 KC. Fundamentals: 6 Bands
- ★ Full 1.0 Volt Maximum Output
- ★ 30%, 400-Cycle Internal Modulation

Over 380 million RCA Radio Tubes have been purchased by radio users. In tubes, as in parts and test equipment, it pays to go RCA All the Way.



*Test  
Equipment*

RCA Manufacturing Co., Inc., Camden, N. J.  
A Service of the Radio Corporation of America

# ACCURATE MICA SHAPES



## FOR EVERY ELECTRONIC NEED

Our Mica stampings have met the exacting specifications of so many tube, condenser and equipment manufacturers that we have no hesitancy in inviting you to match them against your own particular requirements.

They are made of the finest mica obtainable . . . Munsell's India Ruby Mica. Exceptionally accurate machining is assured by modern manufacturing methods and our long experience in this type of work.

### SEND FOR SAMPLES

Use the coupon below to obtain further details, prices and samples—without obligation.



MICA INSULATOR CO.,  
198 VARICK ST., NEW YORK, N. Y.  
Send me samples and prices on Mica Stampings

Name .....

Company .....

Address..... E. 9-40

## Electronic Musical Instruments

A RATHER COMPLETE DISCUSSION of development of the electronic musical instruments is presented by G. T. Winch and H. M. Midgley in the August 1940 issue of *Electronics and Television & Short-Wave World*. The three major groups of such instruments, i.e., single-note form, multi-note keyboard percussion form and multi-note keyboard organ form are discussed from their early developments to their present-day designs. The advantages and disadvantages of a number of signal sources are given. Such sources include multiple oscillator circuits and the various forms of rotary generators with photoelectric, electrostatic and electromagnetic pickup. While most of the emphasis of the article is on the various methods of producing the musical tones, the authors discuss briefly the necessary mixing circuits, amplifiers and loudspeakers. To anyone interested in the design and construction of electronic musical instruments, the time taken to read this article will be well spent.

• • •

## Heavy-Water Rochelle-Salt Crystals

THERE APPEARS IN THE August 1940 issue of the *Bell Laboratories Record*, a short article discussing Rochelle salt crystals made with heavy water. It is stated that the limitation of the use of ordinary Rochelle salt crystals is the fact that there is a rapid loss of the piezo-electric properties above 75 degrees F. It was found that if the Rochelle salt crystals were made with heavy water instead of with ordinary water, the piezo-electric properties would be retained up to 95 degrees F. The use of these crystals will undoubtedly become more widespread with this extension in the useful temperature range.

## R.A.F. APPRENTICES



Thousands of boys, recruited at the age of fifteen and one-half years are given a three years' apprenticeship course by the Royal Air Force before beginning intensive flight training



## ALLIED . . . . . CIRCLE SENSITIVE RELAY

The Circle line of relays is a new addition to the growing line of Allied quality relays. Rugged, precision made, assembled on moulded Bakelite base—has many mechanical and electrical features that assure long life under the most severe operating conditions.

Suitable for thermal regulators, electronic devices, ultra sensitive control circuits; in low current supervised circuits such as burglar and fire alarms, voltage control circuits, keying, tuning devices, e'c. Operating characteristics—for A.C.—as low as one mill at 110 volts, 60 cycles with a 50% drop out value; for D.C.—as low as .012 watts with 80% drop out value.

Dimensions—over-all 2 3/8" wide; 2 3/4" long; 1 3/4" high

Also manufacturers of a complete line of relays for all communication and electronic uses.

Write for complete descriptive literature and prices.

**ALLIED CONTROL CO., INC.**  
227 FULTON STREET NEW YORK CITY  
Export Department:  
Pan Mar Corp., 1270 Broadway, New York City

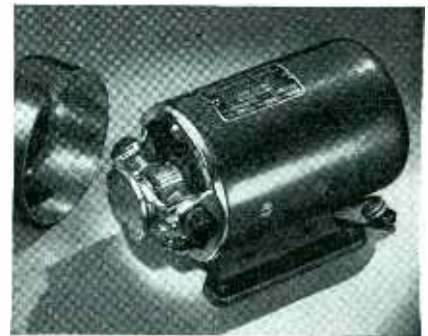

## EICOR DYNAMOTORS

From the Smallest in Size  
to the Largest in Output!



Engineered and built for the most exacting use—specified by engineers everywhere for important Aircraft, Police, Marine and Amateur radio installations—proved right in actual performance! Eicor Dynamotors assure the kind of smooth, continuous trouble-free service that gives you the utmost efficiency and dependability. There is an Eicor Dynamotor for every need—from the smallest in size to the largest in output!

Write Today for Complete Data.

### EICOR INC.

517 S. Laffin St., Chicago, U.S.A.  
Export: AD AURIEMA, INC., 118 Broad St.  
New York, N. Y. Cable: Auriema, N. Y.



## Recent Improvements in Recording

(Continued from page 35)

He then measured the pattern width at each level, with the results shown in the figure. The result seemed to show input and output completely proportional up to an input of +28 db. Unhappily records cut at +10 db sounded hopelessly bad. He was at his wits end to find a curve with which to reject the cutter. Finally we played the record back into a distortion meter of the high-pass filter type. The result, shown in the figure, speaks for itself.

This discrepancy can be accounted for when it is realized that the optical pattern measures the peak velocity—which occurs when the groove cuts the zero axis, i.e., at the point of minimum deflection. Therefore, anything which affects the wave shape at a point other than zero amplitude will not affect the pattern width. Saturated iron or a saturated crystal of course affect amplitude peaks—which are at zero velocity. Summarizing both points, the only way of measuring distortion is with a meter, and even then the meter reading must be viewed rather critically.

There is another type of distortion which is destined to increase, unfortunately. This is tracking distortion. Years ago every recordist had his own ideas on stylus shape. No two makes of records had the same groove cross-section. Nevertheless there was no tracking trouble—for every pickup used steel needles, which would grind themselves to a good fit in any groove. Later nearly everyone standardized on the 87 degree angle. Today, as permanent point pickups are becoming standard, fixing the 87 degree, 2.1 to 2.3-mil radius point, the desire to try trick point shapes has returned. Nothing could be more unfortunate at the moment, regardless of the merits of the new shape. The average station cannot afford several pickups with various point shapes, and it certainly cannot change points with every record. It is bad enough to have five or six frequency characteristics in use without having to worry about groove shape too.

**DAVEN**  
**Precision LEVEL INDICATOR**

The Type 91C Volume Level Indicator is an audio level indicator designed for service in broadcasting, sound recording, and allied fields. The meter is sensitive, rugged and correctly damped for program monitoring. The meter multiplier is a heavy duty, step "type T" attenuator designed to offer a constant impedance both to the line, and to the meter at all steps of control. The zero adjustment provides corrections of  $\pm 0.5$  Db. in 0.1 Db. steps. The input impedance of the 910 is 7500 ohms. The reference level is 1 mw. into 600 ohms.

WRITE FOR TECHNICAL DESCRIPTIVE LITERATURE  
**THE DAVEN COMPANY**  
158 SUMMIT STREET - NEWARK, NEW JERSEY

**BLILEY**

*Precision Made*

**CRYSTAL UNITS**

20 KC TO 30 MC  
WRITE FOR CATALOG G-J

**BLILEY ELECTRIC CO., Erie, Pa.**

**They're "Tops!"**

THE Stratoliner—one of the new, giant Boeing "307's" recently delivered to TWA—is equipped throughout with CANNON PLUGS (Cable Connectors). They are "tops" in the fields of Sound, Aircraft Service, Geophysical Research, Instrument-Control on Ships and Laboratory Panels.

**CANNON ELECTRIC DEVELOPMENT CO.**  
420 West Avenue 33, Los Angeles, California  
Eastern Sales Office: 220 Fifth Ave., New York, N. Y.

## CANNON PLUGS.

### PERMANENT MAGNETS

ALL SHAPES — ALL SIZES  
FOR ALL PURPOSES

Stamped, Formed, and Cast; Chrome, Tungsten, Cobalt and ALNICO\*\* (cast or sintered) under G. E. license.

**THOMAS & SKINNER**  
STEEL PRODUCTS COMPANY  
1116 E. 23rd STREET INDIANAPOLIS, INDIANA

Laminations for Radio Transformers — Tools  
Dies — Heat Treating — Stampings

**39 YEARS EXPERIENCE**

## AUDIO SIGNAL GENERATORS

A new instrument providing standardized audio frequency voltages

- 5 Watt output from 20-20,000 cps
- Distortion less than 1%
- Output meter to set voltage
- 110 db. Attenuator with 1 db. steps
- Universal Impedance Output
- Large Dial with planetary drive

Available with separate input meter for gain measurements

The MODEL 205 AG  
Write for complete information about these and other instruments.

**HEWLETT-PACKARD CO.** 481 PAGE MILL RD. PALO ALTO, CALIF.

If a new permanent-point pickup just doesn't sound right, quite likely tracking trouble is the cause. The jewel point must be lined up properly with the groove. It is wise, therefore, to follow minutely the manufacturer's directions for positioning, otherwise the result may be disappointing and the cause difficult to find.

Recently the writer received an urgent call from a station reporting that audition records of the instantaneous variety were not standing up for much over six to ten playings, when they had had almost indefinite life in the past. It was found that the turntables were used for ordinary shellac pressings, vinylite pressings, and acetate. Steady service had chipped off minute bits on the permanent-point needle tip, leaving microscopic chisel points. Shellacs were hard enough to withstand such treatment. Transcriptions were played a few times and had no chance to wear. Acetate audition records, played often, got the blame. There was only one remedy: a pair of new diamond points. This should serve as a warning that "permanent" is a misnomer. Even the diamond will wear at two ounces pressure. Worse than that is the impact of dropping on a hard pressing, for jewels are brittle.

In a previous article the writer commented on consumer pressure for softer, more foolproof and therefore inferior instantaneous blank coatings. Pressure of this sort has abated somewhat as dealers have learned to diagnose and cure consumer troubles. Another type of pressure toward the same end has arisen lately. Realizing that any type of coating (regardless of formula) can be softened and made quieter by addition of a higher percentage of plasticizers, a number of broadcasters have requested such a soft coating. This is not a move for better results. If the record is to be an audition or artist's record, exceptionally low initial noise level is of little importance compared to the rapid rise of scratch due to low durability. Some soft records have lasted for only four to eight playings. If the record is to be processed, the lower noise is completely submerged by processing, whereas the reduced high frequency response (inevitable in a softer coating) will

The kind of performance  
*Engineers look for!*

Test instrument features make impressive reading. RCP lists them. But more vital to radio engineers is equipment dependability. RCP's high standards—proven in performance, and its mastery of the engineer's requirements—means that you can rely on these test instruments for genuine, lasting satisfaction.

### NEW RCP AC-DC MULTITESTER

#### 414 SERIES

- AC scales practically linear, coinciding with DC, eliminate confusion of an additional AC scale.
- FUSED 4½ inch meter, supply line double fused.
- 2,000 ohms per volt sensitivity; accurate within 2%.
- Low ohm scale 2 ohms at center. Self-contained ohmmeter power supply.
- DC volts 0.5/50/250/2500/5000; AC volts 0/10/100/500/1000/5000; DC mills 0/10/50/250/1000; DC amp 0/1/5/25; Capacity Mfd. 0/.03/.3/3/30/300; Low ohms 0-100; Ohms 0-15,000/150,000; Meg. ohms 0-1.5/15.
- Open face bench type furnished in sturdy hardwood case. **\$21.95**



Model 414P — Combination portable bench type. Net. \$24.50

Model 414 Series V7 — Large 7¼" bakelite meter. Net. \$29.95

Model 414 Series V9 (same as V7, except meter 9" round). Net. \$32.95

Model 414 Series RP7 — Similar to VP7 except horizontal. Net. \$29.25

Model 414 Series RP9 — (Identical to RP7 except meter 9" round). Net. \$32.95

### MASTER ANALYST MODEL 504C

A super flexible circuit selector, free point, free reference unit for plug in socket analysis of voltage and current resistance capacity measurements. Completely push-button operated, this analyzer unit combines every advantage of both rotary and button switches, thus is more useful, efficient, foolproof, speedy and convenient than average instrument. **\$15.45**



**CATALOG No. 124** describing in detail these and other instruments in RCP's complete line of dependable test equipment free on request. Write today.

*Dependable*

**RADIO CITY**  
PRODUCTS CO. INC.  
88 PARK PLACE, N. Y. C.

seriously injure the record quality. A soft and resilient coating may be seriously down in frequency response (both in the original and in a pressing) even at 5000 cps which compare poorly with ordinary 75-cent black-label pressings, many of which are now produced with frequency response flat to 8000 or 10,000 cps.

## Operation of a Self-Excited Inverter

(Continued from page 39)

up and then both would rise to normal values. In an attempt to show this effect, a circuit was arranged to add and subtract an increment of load rapidly. The results are shown in the oscillograms of Fig. 10, where A is with a non-inductive addition, B with an inductive addition, and C with a capacitive addition to the base load.

As will be realized from a study of these tests, the regulation of this inverter is poor. This is not a fault of this inverter alone, but is characteristic of almost all inverters up to the present time and is one of the reasons why practical applications of this type of apparatus have not been more numerous. This poor regulation requires some means of adjusting the direct current input voltage and usually requires some power-consuming device in this circuit unless the inverter is operated directly from a d-c generator whose field may be adjusted, or from a grid-controlled rectifier.

Practical applications of this particular type of inverter are hard to foresee although it has been used in one type of electronic instrument. It might be of use in the laboratory where a small power source of widely variable frequency is desired. Inverters are in their infancy and much remains to be done before they can be widely applied; yet they are of great interest and further work will in all probability bring forth improvements which should make them of greater practical value.

#### REFERENCES

- (1) Tompkins, F. N., *Trans. Am. Inst. Elec. Engrs.* 51, 707 (1932).
- (2) Wagner, C. F., *Elec. Eng.*, 54, 1227 (1935); 55, 970 (1936).

**Shure**  
**BROADCAST CARDIOID**

**adopted by prominent broadcasting and recording studios**

There's a surprise in store for the Broadcast Engineer who hasn't yet tried the new Shure "555" Cardioid Dynamic Microphone. The Cardioid is ideal for studio work—and essential when you take a microphone out of the studio for remote pickup where background noise, room reflection and reverberation are big problems. The "555" solves these problems easily and effectively—all this at surprisingly low cost made possible by the exclusive Shure Uniphase principle. That's why broadcast stations now are rapidly replacing present equipment with the "555" for remote as well as studio use. Available in 35-50 and 200-250 ohm models, also high impedance. List price (subject to usual trade discount) only \$60.

**30 Day Free Trial** to broadcast stations and recording studios. Test it. No obligation. Send for it now—or write for Bulletin 165M.

*Shure Patents Allowed.*



**SHURE BROTHERS**  
225 W. Huron St., Chicago, U. S. A.

# THE INDUSTRY IN REVIEW

## Literature

**House Organ.** "Instruments in Industry" is the title of a publication devoted to extending the benefits of electric instruments. It is published by the Meter Division, General Electric Co., Schenectady, N. Y. Some of the articles contained in Volume 2, No. 1, are: "The Radiation-type Vacuum Thermocouple," "New Pointer-stop Ammeter Measures Resistance-Welder Current," "New Inkless Recorder Proving Popular," etc.

**Resistance Standards.** Bulletin No. 810 describes and illustrates resistance standards No. 798, 799, 800, 801, 802, and 810. Also described in the bulletin are megohm decade resistance boxes and heavy duty decade boxes, available from Shallcross Mfg. Co., Collingdale, Pa.

**Frequency Modulation.** Supplement No. 9 to the 3rd edition of the Mallory-Yaxley Radio Service Encyclopedia is devoted to the subject of f-m receivers. Contained in this Supplement are schematic drawings, illustrations, and descriptions of receivers manufactured by General Electric Co., Stromberg Carlson Telephone Mfg. Co., and Browning Laboratories, Inc.

**1941 Master Catalog.** Number 82, Master 1941 catalog, contains 196 pages of information regarding radio equipment available from Lafayette Radio Corp., 100 Sixth Ave., New York City.

**Whiteprint Machine.** Bulletin 187 tells about a new Model F fast-printing whiteprint machine available from Ozalid Corp., Johnson City, N. Y. Model F is a compact printer-developer combination for reproducing engineering drawings, letters, charts, diagrams, etc.

**Dynamic Receiver Analysis.** "Servicing by Signal Substitution" presents a simplified method of dynamic receiver analysis illustrating the extended applications of basic test equipment to the solution of daily service problems using only the tube tester, multi-range meter, and signal generator. It is available for 35¢ from Precision Apparatus Co., 647 Kent Ave., Brooklyn, N. Y.

**Laboratory Test Equipment.** This catalog presents technical information on the various standard resistors, attenuators and measuring equipment manufactured by The Daven Co., Newark, N. J., for use in the communications field. It is well bound and indexed.

**Neoprene.** The Rubber Chemicals Div., of E. I. Du Pont de Nemours & Co., Wilmington, Del., publish "The Neoprene Notebook" which is intended to give facts about Neoprene for the engineer.

**Type HG 50 Kw Transmitters.** A 25-page illustrated booklet (No. B-2248) describing the new air-cooled type HG 50 kw broadcast transmitters has been published by Westinghouse Elec. & Mfg. Co., E. Pittsburgh, Pa.

**Rheostats, Resistors, Tap Switches.** Catalog No. 40 of Ohmite Mfg. Co., (4835 Flourney St., Chicago), has been designed for utmost convenience and as a handy reference for all resistance applications. It is beautifully bound and indexed and contains a wealth of data, dimension drawings and helpful engineering information.

## New Products

### Flashlight Bulb Extension

For use when wiring or other impediments prevent location of a light or flashlight at the point where illumination is needed, Sierra Aircraft Co., Sierra Madre, Cal., have developed a novel flashlight bulb extension which extends the light through any maze of wires, etc. Made in lengths from 6 to 36 ins, the extension has a plug which will screw into any flashlight with the bulb in the opposite socket. It is bendable, and can be made into a hook shape or can be fashioned into its own stand and set in position so that both hands are free to work.

### Short-wave Transmitter

Hallberg's Sychrotone, Inc., 527 Madison Ave., New York City have made improvements in their "Sychrotone" short-wave transmitter for research. Frequency is continuously-adjustable between 65 and 120 Mc; output is up to 25 watts. It can be used for therapy as well as for laboratory investigations of effects of various frequencies and various energies on every type of organic substance or inorganic material.

### Broadcast Tube

A new broadcast tube known as GL-266-B has been announced by General Electric Co., Schenectady, N. Y. It is a high-power, high-voltage, mercury-vapor rectifier, structurally similar to the GL-857-B and completely interchangeable with other 266-B's. The new tube is forced-air-cooled, and has a shielded-filament cathode operating at 5 volts and 30 amps, with a heating time of one minute. The peak inverse anode voltage is 22,000 volts, with an average anode current rating of 10 amps and an instantaneous current rating of 40 amps.

### Wire Wound Resistors

A complete line of non-inductive power wire-wound resistors, from 10 to 200 watts and with any type of mounting, has been announced by the International Resistance Co., 401 N. Broad St., Philadelphia, Pa. These units utilize the Ayrton-Perry type of winding which assures full wattage.



A lineup of 1-kw f-m transmitters in various stages of completion in the G.E. Radio Dept., Schenectady

## Power Resistor Decade Box

A power resistor decade box capable of handling high power so that it can be inserted in actual circuits to simulate working conditions, is announced by Clarostat Mfg. Co., Inc., 285 N. 6th St., Brooklyn, N. Y. This box simplifies and expedites the selection of correct resistance values for any circuit or condition. It is intended primarily for laboratory use, for calibration of meters, and for development work generally. It covers a resistance range of from 1 ohm to 999,999 ohms



at a maximum of 1000 volts, by means of six decade switches on the sloping front panel. Each decade will dissipate up to 225 watts, since only Greenohms (cement-coated wire-wound power resistors) are used for the resistance elements, together with glass-insulated wire for connections. The maximum current per decade is as follows: No. 1, 5 amp; No. 2, 1.5 amp; No. 3, .5 amp; No. 4, .15 amp; No. 5, .05 amp; No. 6, .005 amp.

## Cutting Needles

Steel cutting needles available from Recoton Corp., 178 Prince St., New York City, have been designed to keep their shape, stiff tool metal being used to obtain hardness. Special Swedish

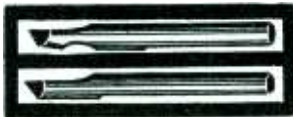

steel alloy retains the cutting edge for a long time. Diamond-dust polishing affords a smooth, more perfect cutting edge, resulting in a quiet, shiny groove. Each style of Recoton needles have a flat on the shank, making it impossible to insert them at a wrong angle.

## Varitran Units

United Transformer Corp., (150 Varick St., New York City) announces that design changes have been made in the UTC Varitran units to enhance their ruggedness and reliability. In addition to glass insulated wire throughout all sizes, multiple contact units now employ ballast coils to assure uniform contact loading. The Varitran units are available for 115 or 230 volts service with respective output voltages of 0-130 and 0-260 volts. Smooth non-interrupted control is effected in all sizes from the 2 amp model V-0 to the 44 amp model V-7.

New

## BRUNO CONNECTORS for HIGH FREQUENCY TRANSMISSION LINES for AIRCRAFT, MOBILE and STATIONARY INSTALLATIONS

Lock nut type—Gas seal and Electrical connections made simultaneously—Friction and constriction contact for center conductor—Safety outer conductor friction collar contact between connectors—Both contacts securely made even if lock nut loosens—May be used on gas filled or normal Transmission Lines—Made from Aluminum Alloy (17 ST)—Heavy Phosphorous Bronze contacts—XXX Bakelite used—Will meet requirements of Commercial Airlines and competent gov't agencies.

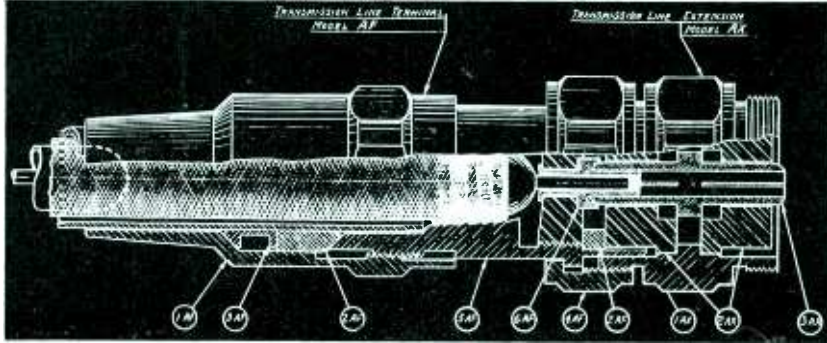

Available in various sizes to accommodate 3/8" 1/2" 3/4" and 7/8" lines—Obtainable in several types and models to meet special application.

Write for Bulletin "C" describing full line.

**SELECTAR MFG. CORP., 30 W 15th St., New York, N. Y.**

## LINGO TURNSTILE ANTENNAS

offer you proven performance

in **FM** operation!

Lingo has set a new pace in the FM field. The Turnstile Antenna developed and tested by Lingo has been proven by years of experience and tests as ideal for FM transmission. Now, when you are ready . . . Lingo will be ready too, to provide this proven antenna, specially designed (for installation) either on your building or on your supporting towers. We would like to send you information about these extraordinary antennas and how we are equipped to furnish complete turnstiles comprising the essential tubular steel mounting pole, elements, insulators, wires, bands, etc.

### Complete Technical Data on Request

Our engineering staff will be pleased to assist you, without obligation, in the development of your FM plans. Inquiries should indicate planned frequency, number of turnstile bays desired, location and height of building or supporting tower.

**JOHN E. LINGO & SON, Inc.**

Dept. E-9  
CAMDEN, N. J.

**LINGO VERTICAL TUBULAR STEEL RADIATORS**

## A Better POWER RHEOSTAT



25-watt unit, rear view, shown actual size.

★ For years Clarostat engineers have sought a better power rheostat. They examined, tested, compared, all types. Hundreds of models were built. The end result is this entirely different Clarostat Power Rheostat. Note these features:

### ★ featuring . . .

- 1 Selected resistance wire on insulated aluminum core, imbedded in cold-setting inorganic cement. Maximum heat conduction and radiation. No corrosion of wire. No weakening of wire through production heat-treatment.
- 2 Tripod-type rotor with helical spring. Smooth, easy, non-binding rotation, always.
- 3 Graphite-copper contact shoe rides third-rail ring and winding, with positive, velvety contact.
- 4 Heavy brass third-rail contact ring which also serves as bearing rail for tripod rotor.
- 5 Heat-resistant ceramic body forming continuous heat-conducting bond through inorganic cement with wire winding. 25-watt rating even at one-third resistance setting. A brute for punishment.

★ **Write** for engineering data on this Clarostat Power Rheostat. Let us quote you on your requirements. Submit any resistance, control or resistance-device problems you may have.



## Noise Filters

A complete line of noise filters, scientifically constructed by P. R. Mallory & Co., (Indianapolis, Ind.), to combat the particular type of man-made interference for which each is recommended, has been introduced. Heavy duty filters in standard cut-out boxes, for use with equipment that is perma-



nently connected to the power line or which draws a minimum of 10 amps or more, are included. Type ZA1 is a capacity and inductance combination using house wiring as an antenna. Field-tested recommendations in technical data folder NF-100 tell the correct type and size of Mallory filter to install to overcome a given character and intensity of interference.

## Ammeter

Model 670 a-c ammeter is one of a new series of matched instruments available from The Triplett Electrical Instrument Co., (Bluffton, Ohio), in



single units or in combination to answer every servicing or electrical analyzing problem. This particular model has a self-contained current transformer permitting measurements on ranges of 0-1, 0-2.5, 0-5, 1-10, and 0-25 a-c amps, 60 cps.

## Relays

Leach Relay Company, Los Angeles, recently introduced a new r-f relay, especially designed for low power radio transmitters, such as are used on aircraft, police cars, etc. This new relay has glazed No. 196 AlSiMag insulation, pure silver contacts, and heat-treated and nickel-plated beryllium copper pole pieces. They are supplied with third pole center, either normally-open, normally-closed, or double-throw and will be supplied with cushioned top contacts, when specified.

## Glass Working Lathe

The Eisler Engineering Co., 740 South 13th St., Newark, N. J., has developed a horizontal butt sealing and general glass working lathe No. 103-XB. This type of machine is employed extensively for the production of large electronic tubes where metal and glass have to be sealed together and various other cylindrical glass work can be performed. The machine will take tubing up to 6 ins in diameter and can be supplied for larger sizes. Many other operations can be performed on this machine.

## Molded Type Resistor

Erie Resistor Corporation, Erie, Pa., announces a new molded type resistor designed to carry  $\frac{1}{2}$  watt load at 40° C, indefinitely. Designated as Type 523, this unit measures  $\frac{3}{8}$  ins long x .143 ins in diameter.  $1\frac{1}{2}$  inch wire leads are parallel to the axis of the body. This wire has a specially developed alloy coated surface that resists oxidation and retains its good soldering characteristics for a long period of time.

These units will safely carry 100 per cent overload with less than 5 per cent change in resistance value after 100 hours. Voltage coefficient is low; a 1,000 ohm unit will drop less than 0.0002 per cent per volt, a 1 megohm resistor will drop less than 0.02 per volt. At 90 per cent relative humidity and 40° C for 1,000 hours, the Type 523 Erie Resistor will increase in resistance approximately 10 per cent.

## Capacitor Analyzer

"Exam-eter," developed by Solar Mfg. Corp., Bayonne, N. J., is a complete capacitor analyzer. It measures condensers both in and out of circuit, power factor; tests for shorts, opens, and high r-f impedance; acts as a capacity and resistance bridge, a megohm meter and a milliammeter; and as a d-c and a-c vacuum tube voltmeter.



Roger M. Wise, Chief Engineer, Hygrade Sylvania Corp., who delivered a paper on new and current tube design at the Pacific Coast Convention of the I.R.E.

## Mu-Switch

A self-lubricating roller on a spring leaf adapts the new Mu-Switch to high speed cam operation, announces Mu-Switch Corp., Canton, Mass. The new type W spring leaf and roller actuator comprises a strong phosphor bronze-leaf spring securely riveted at one end to the Mu-Switch cover and having at its free end a U-bracket which holds a  $\frac{3}{8}$  inch x  $\frac{1}{4}$  inch true-running roller made of graphite-impregnated, canvas-base bakelite. The self-lubricating properties of the roller permit extremely close bearing tolerance with resulting accuracy of cam-controlled action. Quiet operation and freedom from wear or scoring of the operating cam are added advantages.

## Oscillator and Generators

Several new products are available from Hewlett-Packard Co., Palo Alto, Cal. The first is Model 205-A audio signal generator. It includes a resistance tuned oscillator to provide frequency stability, purity of waveform and flexibility of control. The output voltage is adjusted to a known level by means of a 110 db calibrated attenuator and an output voltmeter, both of which are built into the instrument. Specifications are: Frequency range, 20 to 20,000 cps; the output voltage constant within 1 db from 20 to 15,000 cps; distortion is less than 0.02 per cent of output voltage; hum voltage is less than 2 per cent of output voltage. This instrument is available either in relay rack or cabinet mounting.

Model 210-A square wave generator (useful in both production testing and development work) was designed to provide a new approach to the problem of measuring the characteristics of a-f equipment. Only one or two observations are necessary to check the frequency response of apparatus. The output of the generator is square within 1 per cent over the frequency range from 20 to 10,000 cps. The time for the voltage to rise to 90 per cent of maximum is approximately 1 microsecond, thus a reasonably square

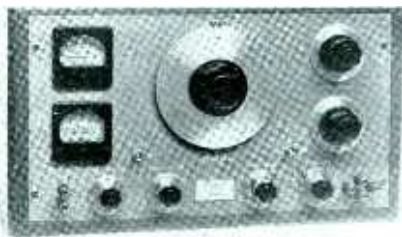

wave can be obtained even at 100 kc. The output voltage is 50 volts peak to peak, across an open circuit.

Model 200-C resistance-tuned oscillator is a wide range instrument which provides a frequency source from 20 cps to 200 kc. This oscillator is suitable for work in the supersonic region, for carrier current work, and for other applications where a wide frequency range is necessary.

# American VR2

A  
**MICROPHONE**  
with  
**A New Idea**  
and a  
**New Usefulness**



PAT. APPLIED FOR

**DIRECTIONAL VARIABLE-RESPONSE  
DYNAMIC MICROPHONE**



The above graph illustrates the average response characteristics for the various settings as indicated on the scale.

Licensed by  
**ELECTRICAL RESEARCH PRODUCTS, INC.**  
under  
United States Patents of A. T. & T. Co.  
and  
Western Electric Co., Inc.  
for use only in public address systems.

**AMERICAN MICROPHONE COMPANY, INC.**  
1915 S. Western Avenue  
BULLETIN No. 36  
PRINTED IN U.S.A.  
Los Angeles, California



**0 to 135  
VOLTS  
stepless**

## VOLTAGE REGULATION

No laboratory is complete without a means of stepless voltage control such as provided by the Acme Voltrol. Manually operated, the Acme Voltrol provides for stepless regulation of A. C. voltage from 0 to 135 volts. For production line testing this unit has no comparison. Put voltage control on all test boards and discover the performance characteristics of your product under all voltage conditions. The NEW Voltrol is lower priced than ever.

Inquiries invited from manufacturers who use small, special characteristic transformers in quantity.

**THE ACME ELECTRIC & MFG. CO.**  
31 Water Street • Cuba, New York

**Acme Electric**  
TRANSFORMERS

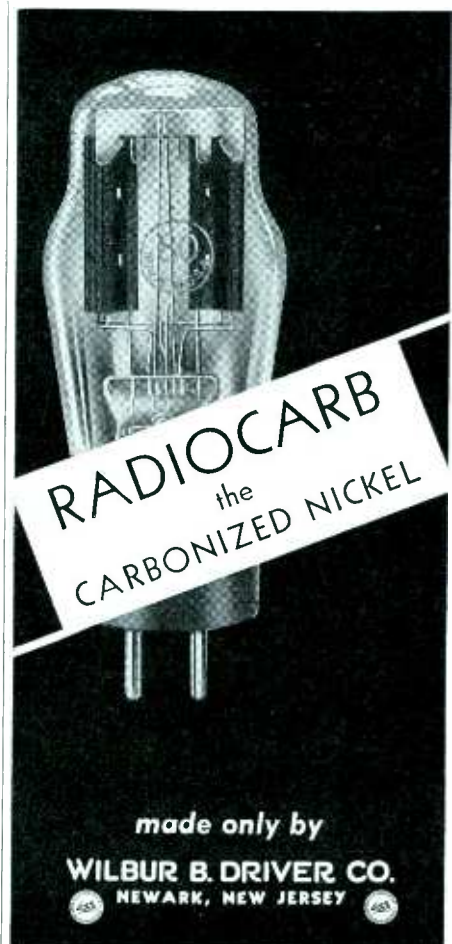

**RADIOCARB**  
the  
**CARBONIZED NICKEL**

made only by

**WILBUR B. DRIVER CO.**  
NEWARK, NEW JERSEY

# NEW ULTRA HIGH FREQUENCY MICROVOLTER\*



\*Reg. U.S.  
Pat. Off.

- Frequency range 3 to 175 megacycles
- Low Resistance Attenuator
- Terminated Transmission Line
- Output .2 to 100,000 microvolts
- Panel Jack for 2 volts output
- 400-1000 cycles and External Modulation

Write for details of this and other instruments of our manufacture

**FERRIS INSTRUMENT CORPORATION**

Boonton,  
New Jersey

For Quality Reproduction  
Use

## Oxford Speakers

Precision built to exacting specifications OXFORD Permaga and Electro-dynamic speakers ranging in size from 2" to 14" will fill the bill no matter what the application.

Send us your specifications for prompt quotations or write Dept. E7 for further information.

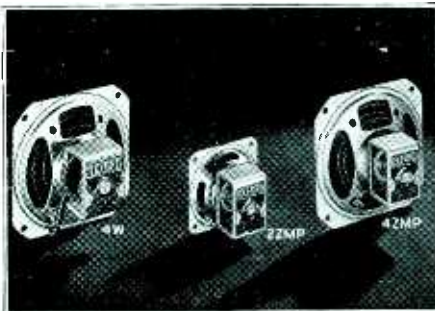

**OXFORD-TARTAN**  
RADIO CORPORATION  
915 W. VAN BUREN ST. • CHICAGO, U. S. A.



## Bringing you an "INSIDE" PICTURE OF TELEVISION

- explains its developments, set-up, problems, operation
- gives complete background of television
- covers business as well as technical aspects of television

SEE THE WIDE RANGE OF DATA  
in these  
**15 CHAPTERS AND APPENDICES**

1. Television and Society.
2. The Television System
3. Putting the Television System to Work
4. Television Programming — Basic Considerations
5. Studio Programs
6. Motion-picture Film Programs
7. Outdoor Pickup Broadcasts
8. The Problem of Network Television Broadcasting
9. Basic Economic Factors
10. The Sponsor in Television
11. The Legal Aspects of Television Service
12. The Technical Elements of the Television System
13. Summary of Regular Service Operations
- A. "The Three Garridebs"
- B. Rules of the Federal Communications Commission Governing Television Broadcast Stations



By **LENOX R. LOHR**

Formerly President, National Broadcasting Company, Inc.

With a Foreword by  
**DAVID SARNOFF**

**Just Out** 274 pages, 6 x 9, illustrated **\$3.00**

This unusual manual shows you the results of foremost American experience with television—describes its set-up and methods of operation—discusses the many considerations of putting programs on the air—explains its problems, economical, technical, legal—everything that will give those in the radio, business, advertising, and entertainment fields the most authoritative and practical basis for consideration of their many questions relating to television.

### 10 Days' Free Examination—Mail This Coupon

McGRAW-HILL BOOK CO., Inc., 330 W. 42nd St., N. Y.  
Send me Lohr's Television Engineering for 10 days' examination on approval. In 10 days I will send \$3.00, plus few cents postage or return book postpaid. (Postage paid on orders accompanied by remittance.)

Name .....  
Address .....  
City and State .....  
Position .....  
Company ..... L. 9-40  
(Books sent on approval in U. S. and Canada only.)

## Circle Sensitive Relays

New relays available from Allied Control Co., 227 Fulton St., New York City, are precision made and are most suitable for thermal regulators, electronic devices, ultra-sensitive control circuits, and in low current supervised circuits such as burglar and fire alarms, voltage control circuits, timing devices, etc. They develop high contact pressure and adequate wiping.



ing. Operating characteristics for ac are as low as 1 ma at 110 volts, 60 cps, with a 50 per cent drop-out value. The coils are vacuum impregnated and are rated at 1 volt to 220 volts with 300 per cent overload. For dc the operating characteristics are as low as 0.012 watts with 80 per cent drop-out value. Coil rating on dc is 1 volt to 220 volts with 150 per cent overload. Contact rating is 1 amp at 48 volts dc and 5 amps at 110 volts ac.

## High Efficiency 50 KW Transmitter

More signal power per kw input is realized in a new air-cooled 50 kw transmitter manufactured by the Westinghouse E. & M. Co. for commercial broadcasters. A new circuit design, resulting in 47.5 per cent overall efficiency, reduces operating costs. The use of air-cooled tubes in all stages eliminates water jackets, pumps, cooling radiators, water storage tanks, distilled water, and attendant expense. Except for the main high voltage rectifier, metal rectifiers of practically unlimited life are used throughout. Some of the other features incorporated in this new transmitter are equalized feedback in audio system, variable compressed gas condensers, fuseless overload protection, spare rectifier tube at operating temperature, ease of adjustment, and the conservative operation of all tubes. The actual space required for the eight unit cubicles of the type HG transmitter, including the main rectifier unit, is 33½ feet wide, 54 ins deep, and 84 ins high. Approximately an equivalent space is also required for supplementary equipment such as modulation transformer, Heising choke, main plate transformer, and voltage regulators.



## Bruno Connectors and Kits

Bruno "Baby" connectors available from Selectar Mfg. Corp., 30 West 15th St., New York City, are of the locking type, designed to improve contact and minimize interrupted circuits. These new sizes have been especially designed for output or loud speaker connections, and are equipped with  $\frac{1}{2}$  inch 27-thread to prevent accidental mixing of cables with microphone input. The manufacturer states that microphone, speaker and chassis connection of all types can now be made swiftly and infallibly with the help of Bruno "Baby" and the standard sizes.

Also available from Selectar Corp. is a universal connector kit which consists of 10 parts intended to save time in making speaker, microphone and chassis connections, also for splicing and phone jack adjustments.

## Recording Assembly

This item is restricted to manufacturers only for operation on their own motors and is known as a manufacturers' type of recording head and arm assembly. Universal Microphone Co., Inglewood, Cal., are the manufacturers producing the unit. The assembly is rugged and compact, non-critical in operation and is not affected by temperature or humidity. Adjustable needle pressure and pivot bearings are some of the outstanding features. It cuts 118 lines per inch. Cutting head, arm and lead screws are included in the assembly. The weight at the center collects threads at the same time it holds the blank disc in position, and operates as stop and lifter for cutting head at the end of the cut.

## PA Amplifier

Erwood Sound Equipment Company, 224 West Huron St., Chicago, Illinois, have announced Model 2428, a new 28 watt combination 6 volt-110 volt mobile and general PA amplifier. This amplifier is a self-contained unit of portable construction. It has facilities for the use of two microphones, as well as the built-in record playing mechanism. Output impedance is variable to accommodate a variety of speaker installations. Two cables are furnished with the unit, one for each type of service.

Also available is Model 1414 6-volt-110-volt amplifier which is available with a built-in turntable or amplifier chassis only. It has provision for use of one microphone and one phonograph, and in addition has a tone control to equalize the response characteristics. It is also equipped with an output transformer having impedance taps at 3, 6, 250 and 500 ohms. Two cables are also furnished with this unit.

## Wanna Bet . . . ?



Built by Pacific Pari-Mutuel Totalizer, Inc., San Francisco, Calif.

★ Quicker than the wink of a photo-finish camera . . . Controls by Guardian flash giant lite-up numerals on Race-Track Result Boards as shown above.

A complicated and costly set-up? So they figured at the start . . . but Guardian equipment did the job with a single Type "S" Stepping Relay and a few "extras" selected from Guardian's 3700 standard parts . . . at a price that let the little fellows in.

No Gamble On Results . . . Chances are . . . 99 out of 100 . . . Guardian Engineering and Guardian Controls will do your job.

It may look simple . . . tough . . . or even impossible . . . but past performances chalk up odds of a hundred-to-one that Guardian will "score" for you.

HERE'S A TIP—No charge for competent, experienced engineering advice. Send a print or sketch. Initial your letterhead for big new Relay Catalog now



## Select RELAYS BY GUARDIAN



Type "S" Stepper and Control Unit

**GUARDIAN**  **ELECTRIC**  
1625 W. Walnut Street Chicago, Illinois

## LOOK AT THE MOVEMENT—

— and your choice will be  
Simpson Panel Instruments

### A New HIGH-SENSITIVITY TESTER—

● Typical of Simpson Testing Instruments is this Model 260 for television and general servicing with ranges to 5,000 volts A.C. and D.C. at 20,000 ohms per volt D.C. 1,000 ohms per volt A.C.

Negligible current consumption means extreme sensitivity. Resistance ranges from  $\frac{1}{2}$  ohm to 10 megohms; decibel ranges from -10 to +52DB. Model 260 is priced at... **\$2750**



**O**UTWARD beauty is only the start of the Simpson story. The real story is that bridge type movement with soft iron pole pieces illustrated above—heart of all Simpson Instruments.

Here is a better type of construction expressed in finer workmanship. Yet it is found in instruments so moderately priced that they have won undisputed right to be called "the world's greatest value in electrical metering devices."

Ask for bulletins describing ten models covering all requirements.

**SIMPSON ELECTRIC CO.**  
5212 Kinzie Street, Chicago, Ill.

**SIMPSON**  
INSTRUMENTS THAT STAY ACCURATE



Bridge Type Construction—With Soft Iron Pole Pieces



## PROFESSIONAL SERVICES

(Rates on Application)

### BROWNING LABORATORIES, INC.

Design—Development—Construction  
Electronic Apparatus of all Types  
Radio—Amplifiers—Controls  
Frequency Modulation Equipment  
750 Main St. Winchester, Mass.  
Phone: Win. 2121

### ELECTRICAL TESTING LABORATORIES

Characteristics of Vacuum Tubes  
Tests of photo cells, glow lamps, crater lamps,  
Tests of electronic and optical devices  
East End Avenue and 79th Street  
New York, N. Y.  
Phone: Butterfield 8-2600

### HAROLD J. McCREARY

Mem. A.I.E.E. & W.S.E.  
**Consulting Engineer**  
Laboratory Facilities  
Research Electronics  
Development Television  
Design Radio  
Factory Practice Railroad Signaling  
Patent Studies Telephony  
105 W. Adams St. Phone STate 4003 Chicago, Ill.

### F. H. SHEPARD, JR.

CONSULTING ENGINEER  
ELECTRONIC APPLICATIONS  
Specializing In:  
Industrial Control Special Amplifier Design  
Follow-Up Devices Photoelectric Applications  
Radio and Carrier Operated Remote Control  
6167 Cedar Ave., Merchantville, N. J.  
Telephone Merchantville 1111

## Another FIRST...for Advance Relays

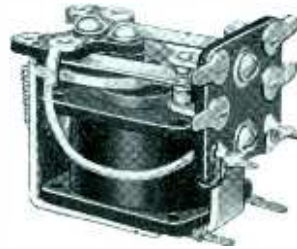

Actual Size

An "honest to goodness" Midget Relay—BUT—easily capable of doing a "man sized job".

Entirely of ungrounded construction and equipped with a single mounting stud for "handy" installation.

DIMENSIONS—1 1/2" x 3/4"—just slightly smaller than an AIRMAIL STAMP. . . !

COILS—1.5 to 115V A.C. or 2 to 32V D.C., in resistances to 1000 ohms.

CONTACTS—DP-ST and DP-DT to safely handle up to 200 watt A.C. loads.

Prices and technical data on receipt of your letterhead.

## Advance ELECTRIC COMPANY

1260 W. 2nd St., Los Angeles, Calif.

## Relay Manufacturers

## Transmitting Tube

A new GL-869-B mercury vapor rectifier employing a horizontal mesh filament has been introduced by the General Electric Co., Schenectady, N. Y. The filament structure of this new tube, proved in both the GL-266-B and GL-857-B tubes, makes it possible to double the average anode current of previous 869's when filaments are connected in quadrature. The GL-869-B is expected to find considerable appli-



cation in 50-kw frequency modulated transmitters. It supersedes the GL-869-A.

When using in-phase filament excitation, the GL-869-B is capable of a maximum inverse anode voltage of 20,000 volts with natural ventilation. The average maximum anode current at 25 cps and above is 10 amps. For quadrature filament excitation, the average maximum anode current is 15 amps. The maximum peak inverse anode voltage is 15,000 volts using forced ventilation.

## Facsimile Duplex Unit

Finch Telecommunications, Inc., Passaic, N. J., have available a duplex facsimile unit designed to transmit and receive facsimile simultaneously. It is suited for mobile use in connection with a portable radio transmitter. Housed in a streamlined case with a window which permits easy view of the printer in operation, the unit has one drum which holds the copy to be transmitted, and a second drum which holds the copy being received. Both actions are independent. The self-synchronizing system of the unit keeps all recorders in step with the transmitter without interference with aural programs.

## Pulse-Generating Circuits

(Continued from page 41)

and  $R_2$  are given elsewhere<sup>3</sup>. The width of the narrower pulse generated by this arrangement for  $C_1 = .001 \mu\text{f}$  and  $R_2 = 10,000$  ohms is of the order of 100 microseconds. The peak is about 100 volts.

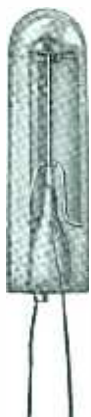

## CETRON PHOTO CELLS and RECTIFIERS

the accepted standard  
with which all others are compared.

## CONTINENTAL ELECTRIC CO.

715 HAMILTON ST. GENEVA, ILLINOIS  
Circulars and Prices on Request

## NEW SUPER HI-POWER GENEMOTOR for Heavy Duty Service



150 Watt, Weight 13 1/2 lbs.  
8 1/2" Long, 4 1/2" Wide, 5" High

Sets a new high standard for Power Units used on Marine, Police, and Aircraft Radio. The exceptional Hi Efficiency, small size, and light weight are the result of a new type, one piece field ring, and armature design. Grease packed ball bearings require no oiling or attention. Double enamel and silk wire on armature insure trouble-free operation, end dust cover removable. Made in two sizes, 150 and 225 watt output, up to 1000 volts, input 5.5 volt and up.

There is a Carter Genemotor or Converter for every requirement. Write for further information

## CARTER MOTOR CO.

1606 MILWAUKEE AVENUE

CHICAGO, ILLINOIS

Figure 3A shows the wiring diagram of a pulser which was designed for use in ionosphere research. Like the circuit just described, it also uses high vacuum tubes and standard radio parts. The pulse at the output terminals is less than 200 microseconds at the base line. The operation of this device is as follows.

#### The Rectifier Pulse Circuit

A small 350-0-350 volt power transformer of the type used in radio receivers, and a single type 80 double diode are connected in a conventional full wave rectifier circuit and feed into a 5,000-ohm load. The voltage of the rectified wave is shown on Fig. 3B. It should be noted that a portion of this wave, having the shape of a V, is formed by the two half cycles as they meet at the zero axis. If the peak voltage is 500 and the apex of the V is 10 volts measured from the zero line, the corresponding time interval represented by the base of the V is

$$T = \frac{\sin^{-1} 10/500}{180^\circ} \times \frac{1}{60}$$

$$= 106 \text{ microseconds}$$

If this V-shaped portion can now be separated from the rest of the wave and then amplified it will result in a pulse the width of which at the base is of the order of 100 microseconds. The rest of the circuit shown on the Figure is arranged to accomplish this result.

The voltage wave across the rectifier load is first shifted to a new zero axis by means of the 8  $\mu$ f coupling condenser. The capacitance of this condenser is purposely chosen so that its impedance is negligible. The voltage applied to the type 76 triode is essentially the same as that across the bleeder, Fig. 3C. This tube acts as a rectifier, and alternate peak suppressor. Thus since the voltage to the plate of the tube is alternating the tube will conduct only during the portions of the cycle when the plate is positive with respect to cathode. Furthermore since an alternating potential is used on the grid some positive peaks will be passed freely while others will be suppressed if they arrive at the instant when the grid potential is very negative. With this arrangement alternate peaks of

the plate voltage are suppressed while the remaining ones are passed. This is done by shifting the grid a-c voltage 90 electrical degrees with respect to the line voltage. The grid of the 76 receives a voltage sufficient to "wipe off" alternate peaks.

The phase shift is accomplished by placing a network consisting of the condenser  $C_1$  and resistor  $R_1$  in series across a 6.3-volt winding of the power transformer. The alternating voltage applied to the grid of the 76 triode is obtained as shown on the diagram. This arrangement makes possible an output voltage across the resistor  $R_2$  of a shape shown on Fig. 3D.

This voltage is next applied to the 6C6 pentode biased beyond cut off. By properly adjusting the bias on the pentode an output voltage of the form shown on Fig. 3E is obtained. The amplitude of the pulse is about 100 volts.

The d-c potentials required for the plate, screen and control grid of the pentode are readily obtained from the high side of the power transformer by means of a separate rectifier. Since the total d-c power required is small a simple filter circuit may be used.

The pulses generated by the methods described here in general must be applied to the controlled circuit at the proper instant. This can be done very readily if the input to the pulser is obtained from the power line through a phase shifting device. A small wound-rotor induction motor may be used for this purpose. The authors, however, prefer a phase shifter of the type shown on Fig. 4, because of its simplicity and low cost. The only precaution to be observed in constructing such a device is that the components used have the proper rating. The range possible with such an arrangement is from about 15 degrees to 165 degrees. And additional phase shift of the same amount, of course, may be secured by reversing the primary leads of the power transformer with a double pole double throw switch.

#### REFERENCES

1. Friend, A. W., "Pulsing Amateur Transmitters for Ionosphere Sounding." *Radio*, No. 236, February, 1939, page 28.
2. Reich, H. J., *Theory and Applications of Electron Tubes*. McGraw-Hill, 1939, page 452-454.
3. Arguimbau, L. B., "Network Testing with Square Waves." *General Radio Experimenter*, Vol. XIV, No. 7, December, 1939.

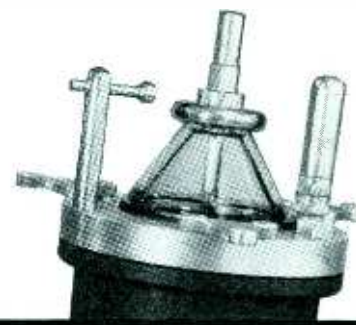

*- to install  
and forget*

**The TYPE 174 COMPRESSED GAS CONDENSER is the complete solution to your tank and antenna tuning problems.**

WRITE FOR DATA



## WIRE & RIBBON

For Direct-Heated  
**ELECTRON EMITTERS**

in VACUUM TUBES

A Complete Range of Sizes and Alloys for

- ★ TRANSMITTING TUBES
- ★ RECEIVING TUBES
- ★ BATTERY TUBES
- ★ HEARING-AID TUBES

Melted and worked under close supervision to assure maximum emissivity, uniformity and the highest tensile strength

WIRES drawn to .0004" diam.  
RIBBON rolled to .0001" diam.

SPECIAL ALLOYS made to meet individual specifications

Write for list of stock Alloys

**SIGMUND COHN**

44 Gold St.  New York City

★

## Copies of the RADIO FREQUENCY CHART

published with this issue are available for 25 cents, mailed unfolded in a tube, suitable for framing or desk-top use. Copies of the colored chart of the ether, radio, audio and photoelectric spectra, published in the April 1940 issue, are available at the same price. Orders of either chart for 25 copies or more are filled at 15 cents each. Specify whether the radio frequency chart or the colored spectrum chart is desired. Address requests, with remittance, to the editorial secretary, Electronics, 330 West 42nd St., New York.

## SEARCHLIGHT SECTION

(Classified Advertising)

**EMPLOYMENT : BUSINESS : "OPPORTUNITIES" : EQUIPMENT : USED OR RESALE**

UNDISPLAYED — RATES — DISPLAYED

10 CENTS A WORD. MINIMUM CHARGE \$2.00  
Positions Wanted (full or part time salaried employment only) ½ the above rates payable in advance.  
Box Numbers—Care of publication New York, Chicago or San Francisco offices count as 10 words.  
Discount of 10% if full payment is made in advance for 4 consecutive insertions.

Individual Spaces with border rules for prominent display of advertisements. The advertising rate is \$6.00 per inch for all advertising appearing on other than a contract basis. Contract rates quoted on request.  
An advertising inch is measured ¾" vertically on a column — 3 columns — 30 inches to a page.

### HIGH GRADE USED ELECTRON TUBE MACHINERY

*Huge Stock of Every Type and Variety*  
**KAHLE ENGINEERING CORPORATION**  
Specialists in Equipment for the manufacture of Neon Tubes, Radio Tubes, Incandescent Lamps, Photo Cells, X-ray Tubes, etc.

900 DeMott St., North Bergen, N. J.

### DEPENDABLE

Used  
**ELECTRONIC TUBE EQUIPMENT**  
Complete line of used equipment for the manufacture of Radio Tubes, Neon Tubes, Incandescent Lamps, etc. Write for Bulletin showing 25 to 75% savings.

**CALLITE TUNGSTEN CORPORATION**  
formerly Eisler Electric Corp.  
534 39th Street, Union City, N. J.

### We are in the market for the following VACUUM TUBE MACHINERY

- 8-head stem machines.
- 4-head flare machines.
- Dumet wire cutter and bender, etc.

*Communicate with*

**INTERNATIONAL NEON PRODUCTS**  
16 N. May St. Chicago, Ill.

### POSITIONS WANTED

(See also "Salesman Available")

**PHYSICIST**—Nine years experience in design, development, production and application of high vacuum and gaseous discharge tubes. PW-243, Electronics, 330 W. 42nd St., New York City.

**STUDIO ENGINEER** now connected with Midwest NBC outlet. Present position two and one half years' satisfactory record. Age 22, hold 1st Telephone and 2nd Telegraph Graduate of RCA. PW-206, Electronics, 520 N. Michigan Ave., Chicago, Ill.

### SALESMAN AVAILABLE

**SALES ORGANIZATION.** Well established and acquainted with radio and Electrical Manufacturing industries in Chicago, Indiana and Ohio. Sales and office staff, shipping and warehousing facilities. Available for bona fide established components manufacturer. SA-205, Electronics, 520 N. Michigan Ave., Chicago, Ill.

### INSTRUCTIONS

Commercial Radio Operators Examination Questions and answers two dollars per element. G. C. Waller, 6540 E. Washington Blvd., Tulsa, Okla.

## New Books

(Continued from page 42)

### Cathode-Ray Tubes

BY MANFRED VON ARDENNE. *Translated by G. S. McGregor and R. C. Walker. Isaac Pitman and Sons, Ltd, London (Pitman Publishing Corp., New York), 1939. 530 pages, 465 illustrations. Price \$12.50.*

THIS BOOK IS AN EXHAUSTIVE TREATMENT of cathode-ray practice in Europe (particularly in Germany) from the early history of the art to the year 1937. The original German edition was written in 1933, and the English translation three years later. The book is authoritative and covers a wide range of subjects but its usefulness to American readers is somewhat limited by its high price, by the emphasis on gas-focused tubes (which are virtually unknown in the U.S.) and by the fact that many of the more up-to-the-minute applications and practices are not included. Nevertheless the basic principles of cathode-ray production and deflection, characteristics of phosphors, auxiliary apparatus and applications are thoroughly covered. To specialists in the field, the book will prove worthwhile for its thorough discussion of many of the second-order effects which influence the formation and deflection of electron beams in various types of electron guns, at high frequencies, etc.

The first part of the book is concerned with the cathode-ray tube itself, including the theory of the electron gun, deflection systems, effect of gas on focusing, modulation of the beam by anode voltage variation and by control grid, as well as practical constructions of c-r tubes (mostly of European design). The second part deals with accessory apparatus, power supplies, sweep circuits, signal amplifiers, capacitive- and direct-coupled, audio-frequency and mechanical vibration auxiliaries. The principles of photographing cathode-ray tube traces are thoroughly discussed in this section.

The third chapter presents an encyclopedic review of equipment for making measurements with c-r tubes, including observation of the path of the ray, uses in high frequency technique, tracing characteristic curves, making audio frequency studies, measuring modulation percentage, distortion, measurements in mechanical engineering and in medical research. The last sections, on the c-r tube as an operating unit, treat its functions in sound recording and in television reception. The latter material is considerably out of date judged by present standards. Complete bibliographies and a useful index are included.—D.G.F.

## British Patents

### Electron Tube Applications

**Machine Control.** A grinding or polishing machine for treating metal sheets, etc., comprises an endless abrasive belt moving parallel to the movement of a reciprocating work table, and also has lateral movement to distribute wear and avoid scratching the work. The motor is controlled automatically to shift the belt through a predetermined range by means of two photo-electric cells arranged so that when the edge of the belt interrupts a beam of light from a source the motor runs forward, and when the edge allows a beam of light from another source to reach the second cell the motor is reversed. Mattison Machine Works. No. 502,898.

**Printing Control.** In multi-color printing on substantially cylindrical articles such as bottles, cans, etc., a photo-electric device is provided to determine the position of the article about its axis to ensure correct registration. F. Shurley. No. 507,089.

**Level Determination.** A device for determining the level or height of substances or liquids in containers or for testing the dimensions of articles according to predetermined tolerance limits comprises a source of light for projecting a spot of light at an angle on the surface of the substance and a light sensitive cell located so as to control ejecting or other mechanism in relation to a predetermined level or size. V. H. Gilbert. No. 507,185.

**Fluorescent Materials.** A blue-fluorescent material is prepared by heating together the oxides of calcium and tungsten, the CaO being in excess of the amount required by the formula  $\text{CaWO}_4$ , e.g. 21 parts by weight of calcium oxide to 70 parts of tungstic oxide. Instead of the oxides, compounds such as calcium carbonate and tungstic acid may be used, which yield the oxides during the heating process. A lead compound, e.g. the acetate, may be added to provide 0.5 to 1.5 per cent of lead as activator. The material may be used with electric discharge lamps, and in particular may be coated on the inner surface of the container of an electric discharge lamp by means of a binder, or may be embedded in or dusted on the glass. A binder such as glycerine, glycerine and boric acid, phosphoric acid diluted if necessary with alcohol or acetone, potassium silicate, an ester of glycerine with boric acid, castor oil, or mineral oil is suitable. Such a lamp may have an efficiency of 22 lumens per watt. No. 509,031. British Thomson-Houston Co.



# CONTACTS

FOR THE FIELD OF ELECTRONICS

**We manufacture a complete line of equipment**



SPOT WELDERS, electric, from ¼ to 500 KVA AC ARC  
TRANSFORMERS, special and standard types WELDERS  
INCANDESCENT LAMP manufacturing equipment From 100 to  
RADIO TUBES, ex-ray cathode ray, photo cells 400 Amps.  
ELECTRONIC EQUIPMENT, vacuum pumps, etc.  
TUNGSTEN SLUGS, rod and wire manufacturing equipment  
GENERAL GLASS working machines and burners  
COLT EDGE GLASS working units for students and laboratory

**EISLER ENGINEERING COMPANY, CHAS. EISLER, Pres.**  
751 So. 13th St. (near Avon Ave.) Newark, New Jersey



**VACUUM TUBES AND  
ELECTRONIC DEVICES**

Design, Development and Construction of  
tubes and circuits.

**VACUTRON, INC.**  
2819 12 St. South Arlington, Va.

**FINE RIBBONS**  
of Tungsten, Molybdenum and  
Special Alloys  
To your specifications

**H. CROSS**  
15 BEEKMAN ST. NEW YORK



**SIGNAL & INDICATOR  
PILOT LIGHTS**  
for all electrical devices.

WRITE FOR CATALOGUE  
showing a complete line of  
assemblies for all purposes.

**SIGNAL INDICATOR Corp.**  
140 CEDAR ST. NEW YORK, N. Y.

**CONSOLIDATED ENGINEERING CORPORATION**

ELECTRONIC ★ OPTICAL ★ VIBRATION ENGINEERING AND RESEARCH  
INSTRUMENT DEVELOPMENT AND MANUFACTURE ★ PATENT STUDIES

1255 EAST GREEN STREET • PASADENA, CALIFORNIA

**"WHAT CAN IT DO  
FOR ME"**

Advertising that is read with this thought in mind, may provide the solution to a problem that has kept you awake nights for weeks.

Remember, back of the signature of every Electronic advertiser is another organization, whose members have thought long and hard about your business in the course of introducing and applying their products or services to your industry.

If their offerings can improve the quality of your company's product . . . or save your company's money . . . they can contribute to your company's income.

We all know, "It pays to advertise." It pays just as big to investigate what is advertised!

Each month, Electronics advertisers, old and new, invite you and over 14,000 other subscribers to investigate further the advantages they can provide.

Departmental Staff  
ELECTRONICS

**ELECTRON TUBE PARTS**

QUALITY All Types EST. 18 YEARS  
Seal Finish Tungsten Welds  
Tungar Welds Coil Springs  
Filament Hooks Bases  
Spot Welders Caps  
Stem Wire Cutting & Forming Machines

**"The Engineering Co." of Newark, N. J., Inc.**  
Daniel Kondakjian, Pres.  
59 Branford Street Newark, N. J.

**A C T O N E**



CUTTING STYLI

For recording direct on all coated aluminum or paper base discs. Individually tapped for a quiet, high quality cut.

**H. W. ACTON CO., Inc., 370 7th Ave., New York**

FILTERS—EQUALIZERS

Lattice Bridged-T Paralleled-T etc.  
Designed and manufactured  
Submit your filter problem

HOLLYWOOD TRANSFORMER CO.  
7364 Melrose Ave. Hollywood, Calif.

? Find what you are looking for? ?

If this or other advertising in this issue does not supply the information of products wanted write

Electronics  
330 West 42nd St., New York City

# "RELAYED-FLUX" MICRODYNE



**M**OST important wide range development since the advent of the pickup in 1926. The "RELAYED-FLUX" principle makes possible a moving system, far beyond anything yet devised . . . a system that actually approaches the theoretical ideal of zero mass . . . a system capable of reproducing all the fine detail engraved at the original recording.

- Flat within  $\pm 1\frac{1}{2}$  db to 10,000 cycles.
- Delivers consistently uniform response, with the sharp, clean-cut definition of the finest Moving-Inductor system.
- Vibratory-Momentum near vanishing point.
- Absence of distortion.
- Free-floating stylus.
- Designed for and equipped with Jewel Point.
- Point-pressure about 18 grams.
- Immune to climatic changes.

Write for details on this truly remarkable development. . . . Also on the NEW AUDAX HIGH FIDELITY CUTTERS.  
Microdyne models for every purpose.

## AUDAK COMPANY

500 Fifth Avenue New York City

*"Creators of High Grade Electrical And Acoustical Apparatus since 1915."*

### INDEX TO ADVERTISERS

Acheson Colloids Corp.	68
Acme Electric & Mfg. Co.	85
Acton Co., Inc., H. W.	91
Advance Electric Co.	88
Aerovox Corp.	78
Allied Control Co.	74
American Electro Metal Corp.	54
American Lava Corp.	57
American Microphone Co.	85
American Transformer Co.	12
Audak Co.	92
Autocall Co.	69
Automatic Electric Co.	60
Bakelite Corp.	Third Cover
Belden Mfg. Co.	4
Biddle Co., James G.	69
Blaw-Knox Co.	50
Biley Electric Co.	79
Boonton Radio Corp.	63
Bud Radio, Inc.	64
Callite Tungsten Corp.	58
Cannon Electric Development Co.	80
Capital Radio Engineering Institute.	65
Carborundum Co., Globar Div.	60
Carter Motor Co.	2
Centralab Div. Globe Union, Inc.	2
Cinch Manufacturing Corp.	43
Clarostat Mfg. Co.	84
Cohn, Sigmund	89
Consolidated Engineering Corp.	91
Continental Electric Co.	88
Cornell-Dubilier Electric Corp.	49
Cross, H.	91
Daven Co.	79
Doolittle Radio, Inc.	70
Drake Mfg. Co.	61
Driver Co., Wilbur B.	85
Du Mont Labs., Allen B.	65
Eicor Inc.	78
Eisler Engineering Co.	91
Eitel-McCullough, Inc.	9
Engineering Co. of Newark, N. J., Inc.	91
Erie Resistor Corp.	8
Fairchild Aviation Corp.	70
Ferranti Electric, Inc.	67
Ferris Instrument Corp.	86
Formica Insulation Co.	3
General Electric Co.	11
Guardian Electric Mfg. Co.	87
Hallcrafters, Inc.	62
Hewlett-Packard Co.	80
Heintz & Kaufman, Ltd.	89
Hollywood Transformer Co.	91
Hudson Wire Co.	67
Hunter Pressed Steel Co.	76
Industrial Timer Corp.	65
Instrument Resistors, Inc.	73
International Resistance Co.	10
Isolantite, Inc.	13
Jensen Radio Mfg. Co.	6
Johnson Co., E. F.	63
Jones, Howard B.	70
Kenyon Transformer Co.	68
Kester Solder Co.	48
Kurman Electric Co.	76
Lampkin Laboratories	77
Lapp Insulator Co.	5
Lingo & Son, Inc., John E.	83
Littelfuse, Inc.	73
Magnetic Windings Co.	75
Malloy & Co., F. R.	14
McGraw-Hill Book Co.	86
Mica Insulator Co.	78
Millen Mfg. Co., Inc., James	77
Ohmite Mfg. Co.	45
Oxford-Tartak Radio Corp.	86
Parker-Kalon Corp.	46, 47
Pioneer Gen-E-Motor Corp.	69
Precision Apparatus Co.	74
Presto Recording Corp.	59
Radio City Products Co.	81
Raytheon Mfg. Co.	75
RCA Manufacturing Co.	77, Fourth Cover
Richardson Co.	54
Selectar Mfg. Corp.	83
Shure Bros.	81
Signal Indicator Corp.	91
Simpson Electric Co.	87
Thomas & Skinner Steel Pds. Co.	80
Triplett Electrical Instrument Co.	73
Tubular Rivet & Stud Co.	71
Union Carbide & Carbon Corp.	Third Cover
United Transformer Corp.	Second Cover
Vacutron, Inc.	91
Ward Leonard Electric Co.	52
Western Electric Co.	55
Westinghouse Electric & Mfg. Co.	51
Weston Electrical Instrument Corp.	7
White Dental Mfg. Co., S. S.	56
Wilson Co., H. A.	71
Wunderlich Radio, Inc.	61
Professional Services	88
<b>SEARCHLIGHT SECTION</b> (Classified Advertising)	
EMPLOYMENT	90
EQUIPMENT FOR SALE	
Callite Tungsten Corp.	90
International Neon Products	90
Kahle Engineering Corp.	90